



## MMIC VCO w/ HALF FREQUENCY OUTPUT & DIVIDE-BY-16, 23.8 - 26.8 GHz

### Typical Applications

The HMC739LP4(E) is ideal for:

- Point-to-Point Radios
- Point-to-Multi-Point Radios / LMDS
- VSAT

### Features

- Pout: +8 dBm
- Phase Noise: -93 dBc/Hz @ 100 kHz Typ.
- No External Resonator Needed
- 24 Lead 4x4mm SMT Package: 16mm<sup>2</sup>

### Functional Diagram

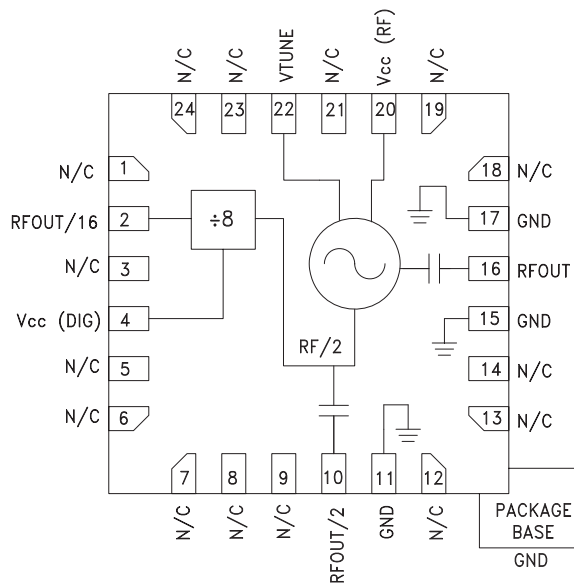

### General Description

The HMC739LP4(E) is a GaAs InGaP Heterojunction Bipolar Transistor (HBT) MMIC VCO. The HMC739LP4(E) integrates a resonator, negative resistance device, varactor diode and divide-by-16 prescaler. The VCO's phase noise performance is excellent over temperature, shock, and process due to the oscillator's monolithic structure. Power output is +8 dBm typical from a 5V supply voltage. The voltage controlled oscillator is packaged in a low cost leadless QFN 4x4 mm surface mount package

### Electrical Specifications, $T_A = +25^\circ C$ , $V_{cc}(RF)$ , $V_{cc}(DIG) = +5V$

Parameter	Min.	Typ.	Max.	Units
Frequency Range	23.8 - 26.8			GHz
Power Output	RF OUT	3	14	dBm
	RF OUT/2	-3	5	dBm
	RF OUT/16	-7	-1	dBm
SSB Phase Noise @ 100 kHz Offset, $V_{tune} = +5V$ @ RF Output		-93		dBc/Hz
Tune Voltage	1		13	V
Supply Current	$I_{cc}(RF)$ , $I_{cc}(DIG)$			mA
Tune Port Leakage Current ( $V_{tune} = 13V$ )			10	$\mu A$
Output Return Loss		3		dB
Harmonics/Subharmonics	1/2	-20		dBc
	3/2	-30		dBc
Pulling (into a 2.0:1 VSWR)		30		MHz pp
Pushing @ $V_{tune} = 5V$		-65		MHz/V
Frequency Drift Rate		4		MHz/ $^\circ C$



**MMIC VCO w/ HALF FREQUENCY OUTPUT  
& DIVIDE-BY-16, 23.8 - 26.8 GHz**

**Frequency vs. Tuning Voltage,  $T = 25^\circ\text{C}$**

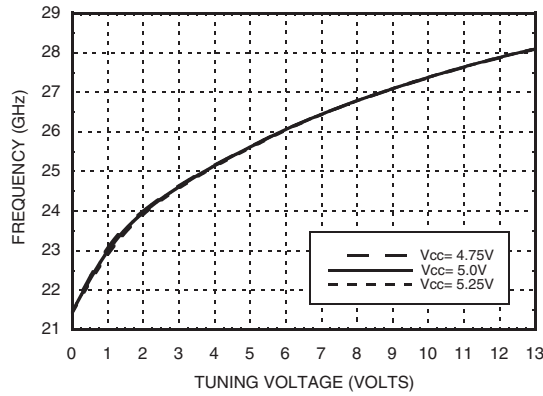

**Frequency vs. Tuning Voltage,  $V_{cc} = +5V$**

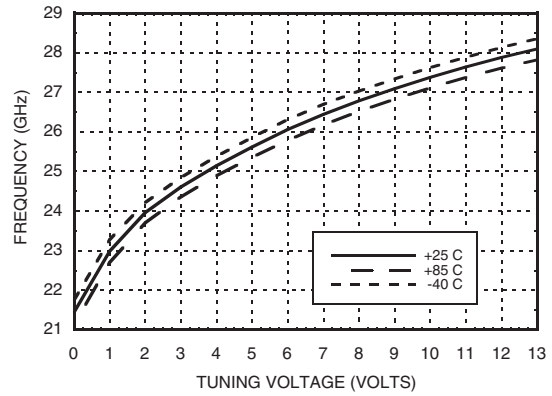

**Sensitivity vs. Tuning Voltage,  $V_{cc} = +5V$**

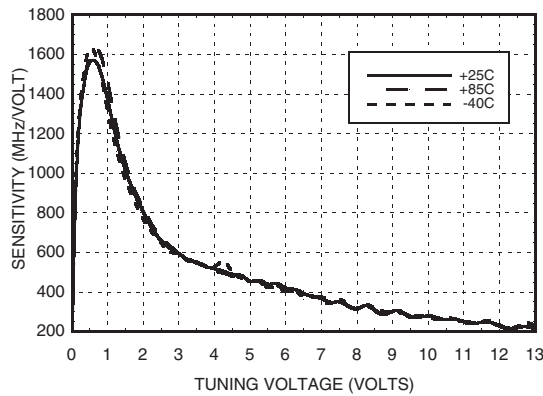

**Output Power vs. Tuning Voltage,  $V_{cc} = +5V$**

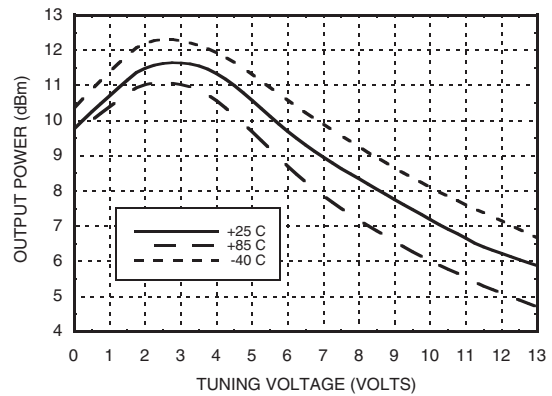

**SSB Phase Noise vs. Tuning Voltage**

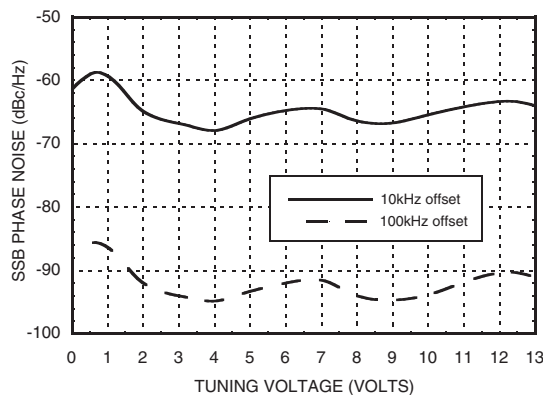

**SSB Phase Noise @  $V_{tune} = 5V$**

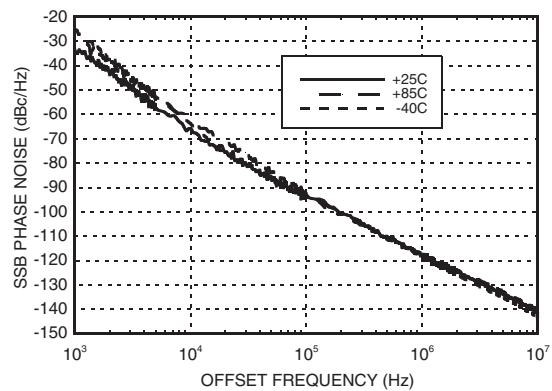



# HMC739LP4 / 739LP4E

## MMIC VCO w/ HALF FREQUENCY OUTPUT & DIVIDE-BY-16, 23.8 - 26.8 GHz

**RFOUT/2 Frequency vs. Tuning Voltage, Vcc= +5V**

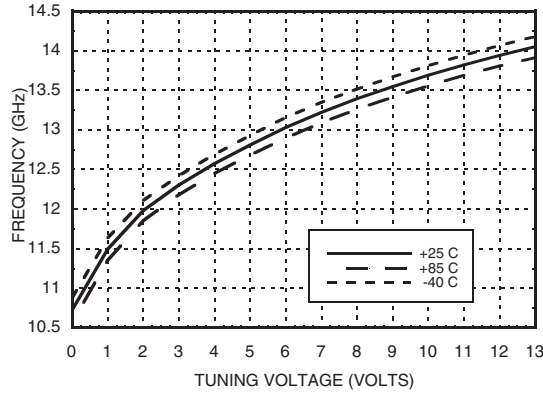

**RFOUT/2 Output Power vs. Tuning Voltage, Vcc= +5V**

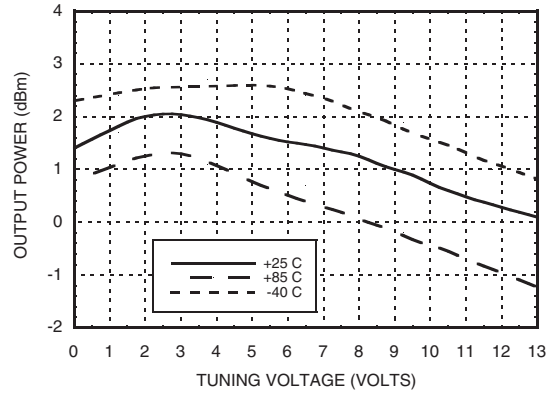

**Divide-by-16 Frequency vs. Tuning Voltage, Vcc = +5V**

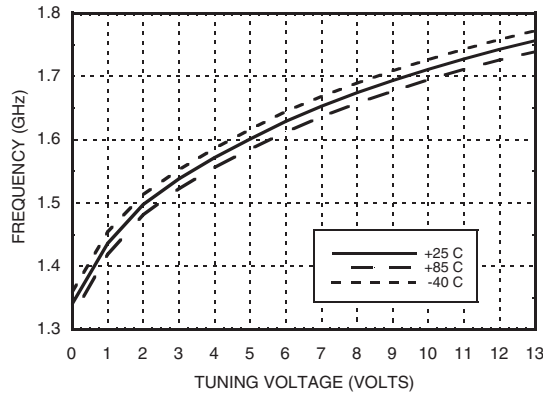

**Divide-by-16 Output Power vs. Tuning Voltage, Vcc = +5V**

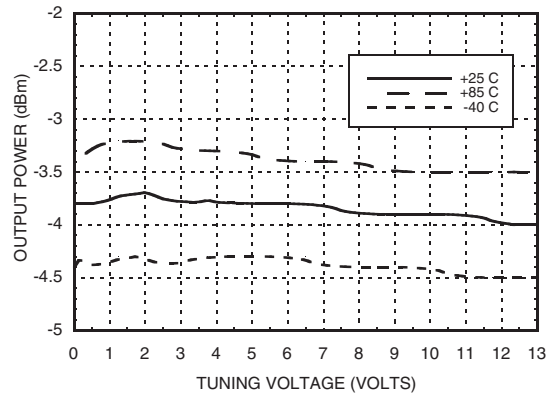

### Absolute Maximum Ratings

Vcc (RF), Vcc (DIG)	+5.5V
Vtune	0 to +15V
Junction Temperature	135° C
Continuous P <sub>diss</sub> (T= 85 °C) (derate 23.3 mW/° above 85 °C)	1.2 W
Thermal Resistance (junction to ground paddle)	43 °C/W
Storage Temperature	-65 to +150 °C
Operating Temperature	-40 to +85 °C

### Typical Supply Current vs. Vcc

Vcc(RF), Vcc DIG) (V)	I <sub>cc</sub> (mA)
4.75	172
5.0	192
5.25	212

Note: VCO will operate over full voltage range shown above.



ELECTROSTATIC SENSITIVE DEVICE  
OBSERVE HANDLING PRECAUTIONS

12

VCOS WITH Fo/2 OUTPUT - SMT

For price, delivery, and to place orders, please contact Hittite Microwave Corporation:

SUNSTAR 微波光电 <http://www.hittite.com> / TEL:0755-83396822 FAX:0755-83376182 E-MAIL: szss20@163.com

Order On-line at [www.hittite.com](http://www.hittite.com)



# HMC739LP4 / 739LP4E

## MMIC VCO w/ HALF FREQUENCY OUTPUT & DIVIDE-BY-16, 23.8 - 26.8 GHz

### Outline Drawing

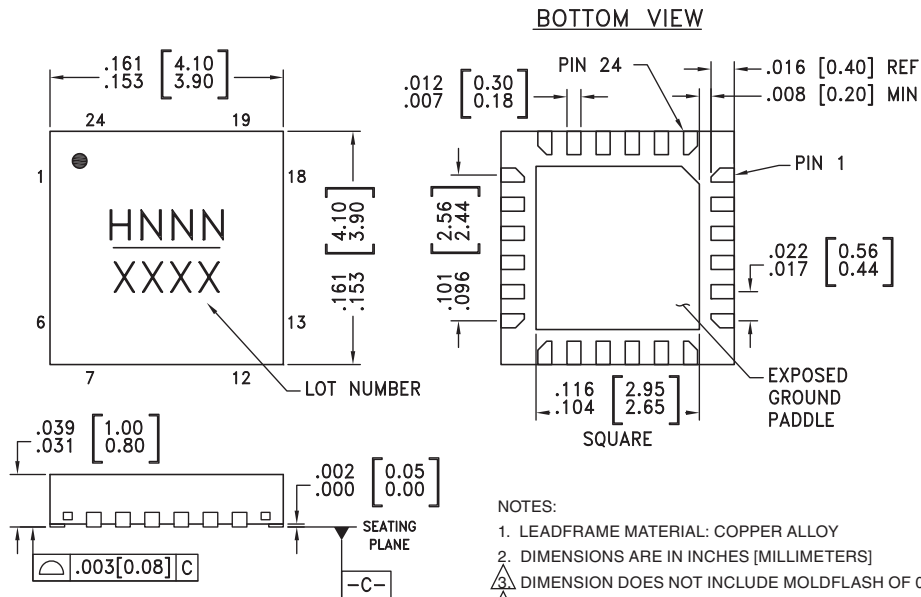

### Package Information

Part Number	Package Body Material	Lead Finish	MSL Rating	Package Marking <sup>[3]</sup>
HMC739LP4	Low Stress Injection Molded Plastic	Sn/Pb Solder	MSL1 <sup>[1]</sup>	H739 XXXX
HMC739LP4E	RoHS-compliant Low Stress Injection Molded Plastic	100% matte Sn	MSL1 <sup>[2]</sup>	H739 XXXX

[1] Max peak reflow temperature of 235 °C  
 [2] Max peak reflow temperature of 260 °C  
 [3] 4-Digit lot number XXXX

### Pin Descriptions

Pin Number	Function	Description	Interface Schematic
1, 3, 5, 6, 7, 8, 9, 12, 13, 14, 18, 19, 21, 23, 24	N/C	No Connection required. These pins may be connected to RF/DC ground without affecting performance.	
2	RFOUT/16	RF/16 Divided Output. Requires DC Block.	
4	Vcc (DIG)	Supply voltage for prescaler. Can be omitted if prescaler is not needed to conserve approximately 100 mA	



**MMIC VCO w/ HALF FREQUENCY OUTPUT  
& DIVIDE-BY-16, 23.8 - 26.8 GHz**

**Pin Descriptions (Continued)**

Pin Number	Function	Description	Interface Schematic
10	RFOUT/2	Half frequency output (AC coupled)	
11, 15, 17	GND	Package bottom has an exposed metal paddle that must be RF & DC grounded.	
16	RFOUT	RF output (AC coupled).	
20	Vcc (RF)	Supply Voltage	
22	VTUNE	Control Voltage Input. Modulation port bandwidth dependent on drive source impedance.	

**Typical Application Circuit**

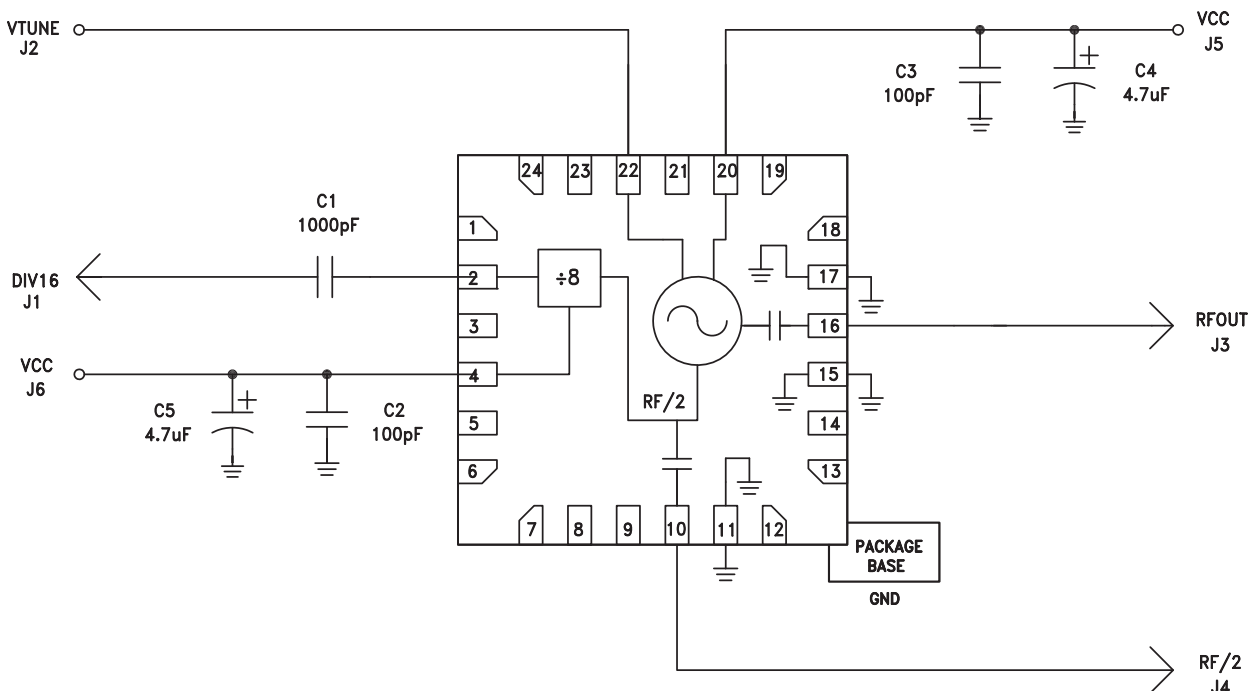



**MMIC VCO w/ HALF FREQUENCY OUTPUT  
& DIVIDE-BY-16, 23.8 - 26.8 GHz**

**Evaluation PCB**

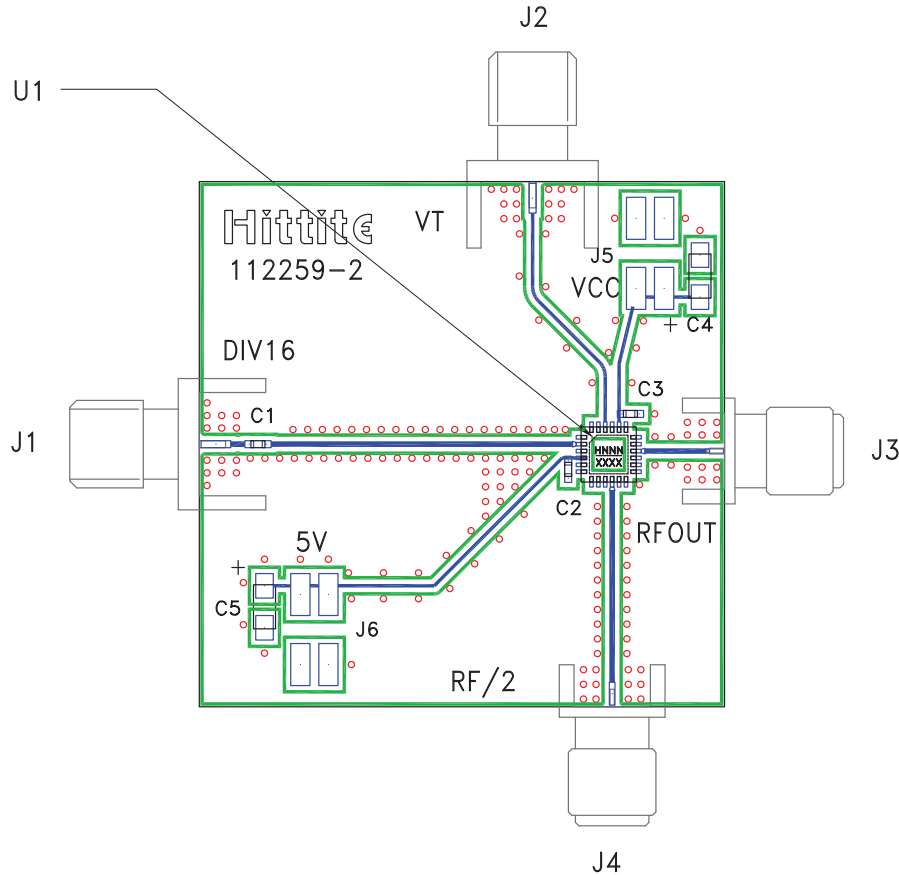

**List of Materials for Evaluation PCB 112261 [1]**

Item	Description
J1 - J2	PCB Mount SMA Connector
J3	PCB Mount K-Connector
J4	PCB Mount SRI SMA Connector
J5, J6	2mm SMT 8 Pin Molex Header
C1	1000 pF, 0402 Pkg.
C2, C3	100 pF, 0402 Pkg.
C4, C5	4.7 μF Tantalum Capacitors Case A
U1	HMC739LP4(E) VCO
PCB [2]	112259 Eval Board

[1] Reference this number when ordering complete evaluation PCB

[2] Circuit Board Material: Rogers 4350

The circuit board used in the final application should use RF circuit design techniques. Signal lines should have 50 ohm impedance while the package ground leads and backside ground slug should be connected directly to the ground plane similar to that shown. A sufficient number of via holes should be used to connect the top and bottom ground planes. The evaluation circuit board shown is available from Hittite upon request.