

GENERAL DESCRIPTION

DV9658 is a CMOS LSI calculator chip with 8 digits arithmetic operations, single memory, percentage and extraction-of-square-root calculations, designed for triplex LCD application with solar cell power supply.

FUNCTIONS

- Four standard functions (+, -, x, /).
- Auto-constant calculations (constant : multiplicand, divisor, addend and subtrahend).
- Square and reciprocal calculations.
- Mark-up and mark-down calculations.
- Extraction of square root.
- Percentage calculations.
- Chain multiplication and division.
- Power calculations.
- Rough estimate calculations.

FUNCTIONAL DESCRIPTION

a. Floating point system

- 8 digits floating decimal point system, with leading zero suppression, Zero shift.
- Symbols : '-' negative number indicator.
: 'E' Error status indicator.
: 'M' Non-zero memory indicator.

b. Error Detections

i) System errors occur when :

- The integral part of any calculation result exceeds 8 digits.
- The integral part of any memory calculation result exceeds 8 digits.
- The integral part of any addend or subtrahend to memory exceed 8 digits.
- The integral part of a mark-up or mark-down calculation result exceeds 8 digits.
- The division by zero.
- The extraction of square root of a negative number.

ii) Rough estimate calculation error

- The integral part of the result of any standard functions, percentage, square, reciprocal or power calculations exceeds 8 digits and is equal to 16 digits or less.

c. Error Indication

i) System error

- '0' is indicated in the 1-digit position and 'E' in the sign indicator position.

APPLICATION

This specification contains complete informations of functional operations, electrical characteristics, packaging, and crating requirements of C9318D.

FEATURES

- Accumulating memory : M+, M-, RM, CM, RM/CM.
- Rollover capability.
- Floating decimal.
- Overflow indication.
- 8-digit LCD triplex.
- Automatic power off function.

ii) Rough estimate calculation error

The high-order 8 digits of a calculation result is indicated together with 'E'. The decimal point is indicated in the position corresponding to a calculation result times 10^{-8} , and no zero shift is performed.

d. Error Release

- i) System error can be released by the ON/C or ON/CE key.
- ii) Rough estimate calculation error can be released by the ON/C, ON/CE, CE key.

e. Number Entry

Numerical can be entered up to 8 digits, entries that equal to 9 digits or more will be ignored.

f. Memory Protection

The memory contents before any error detection are protected.

g. Memory Indication

If the memory contents is non-zero, 'M' is indicated in the memory indicator position.

h. Double Key Depression

The order of priority when two keys are being depressed simultaneously is as follows :

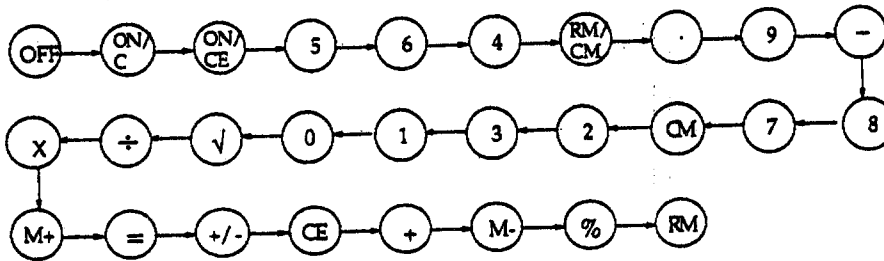

When the OFF and ON/C key are depressed simultaneously, the OFF key is given priority.

i. Key bounce protection

- i) Front edge : down to 1 word and up to about 3 words.
- ii) Trailing edge : 9 words. (1 word is 3.3ms when display frequency is $F_d=100\text{Hz}$.)

j. Auto Power Off

Power automatically turns off after 9 - 11 minutes pass from the last key press.

k. Clear Operation

All operations except memory content are cleared by ON/C key.

ABSOLUTE MAXIMUM RATINGS

Parameters	Symbol	Value	Unit	Note
Terminal voltage	VDD	- 0.3 ~ + 2.0	V	1
	VIN	- 0.3 ~ VDD + 0.3	V	1
Solar Supply Voltage	VSB	1.1 ~ 3.0	V	2
	VGG (LIM)	1.1 ~ 1.8	V	3
Operating temperature range	TOPR	0 ~ + 50	°C	--
Storage temperature range	TSTG	- 55 ~ + 125	°C	--

Note 1 : Maximum voltage on any pin is referenced to GND.

Note 2 :VSB is solar supply voltage.

Note 3 :VGG (lim) is limited voltage.

ELECTRICAL CHARACTERISTICS

(Ta = 25°C, VDD = 1.5V unless otherwise specified)

Parameter	Symbol	Min.	Typ.	Max.	Unit	Test Condition	Note
Input Voltage	V _{IH}	V _{DD} -0.4	--	--	V	--	4
	V _{IL}	--	--	0.4	V	--	
Input Current	I _{IH}	--	--	1	μA	V _{IN} = V _{DD}	5
	I _{IL}	0.3	1	3	μA	V _{IN} = 0V	
Output Voltage 1	V _{OH}	V _{DD} -0.15	--	--	V	No load	6
	V _{OL}	--	--	0.15	V	I _{OUT} = 15μA	
Output Voltage 2	V _{OA}	2.8	2.95	--	V	No load	7
	V _{OB}	1.3	1.5	1.7	V	No load	
	V _{OC}	--	0	0.2	V	No load	
Display Frequency	F _d	40	55	65	Hz	V _{DD} = 1.3V while display is ON.	7
Dissipation Current	I _{OFF}	--	--	0.1	μA	Display is OFF	8
	I _{DIS}	--	4.2	6	μA	V _{DD} = 1.3V while display is on.	9
	I _{OP}	--	6.8	--	μA	V _{DD} = 1.1V, while operation.	10

Note 4 : Applies to Pins K2 ~ K6.

Note 5 : Applies to Pins K2 ~ K6.

Note 6 : Applies to P1, P2, A2X ~ A5X.

Note 7 : Applies to H1 ~ H3, A1 ~ A8, B1 ~ B8, C1 ~ C8.

Note 8 : Measured by the test circuit below after power supply automatically turns off.

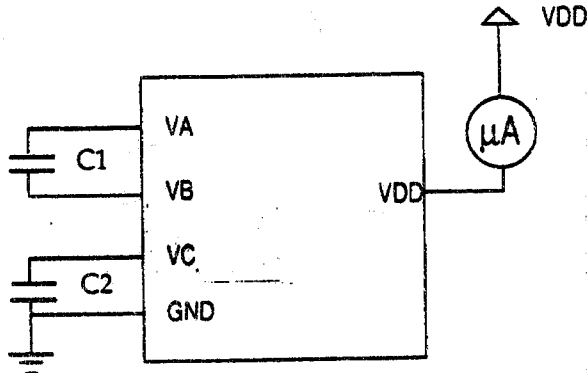

Note 9 : Measured by the test circuit while "0" is being displayed after auto - clear operation and while key is not being depressed.

Note 10 : Measured by the test circuit while operation is being made by ON/C key and while key is not being depressed.

LCD BACKPLANE OUTPUT WAVEFORM

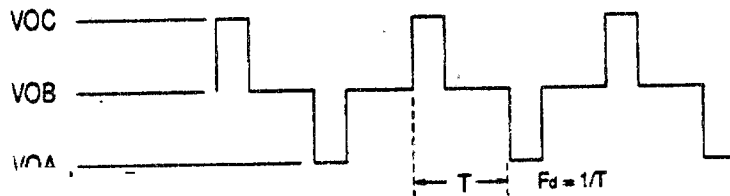

0 1 2 3 4 5 6 7 8 9

b. Sign Font

M

Memory
indicator

-

Negative

E

Error
indicator

LCD CONNECTOR

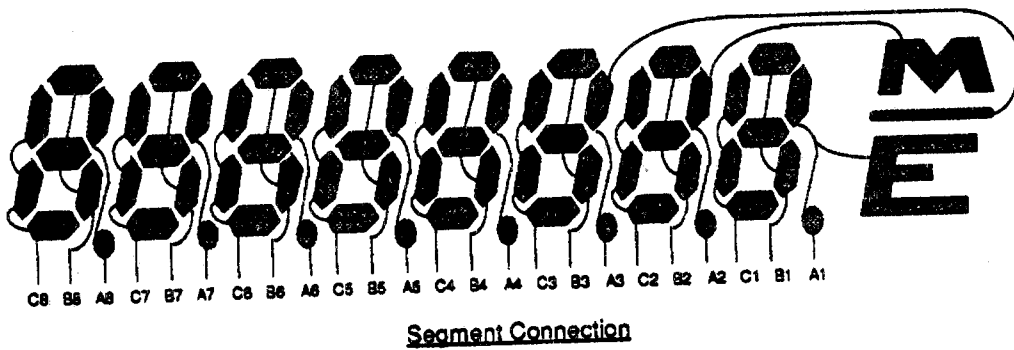
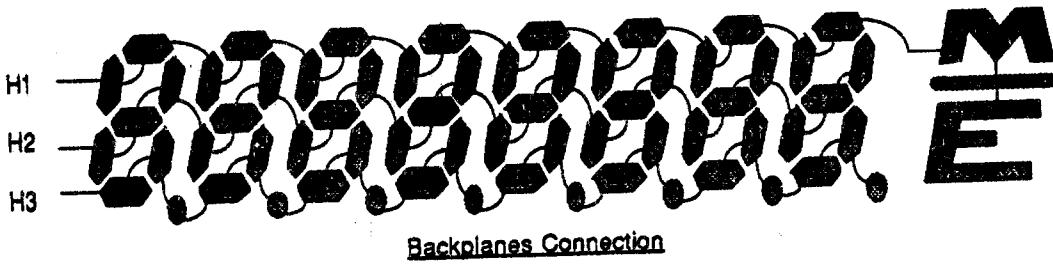
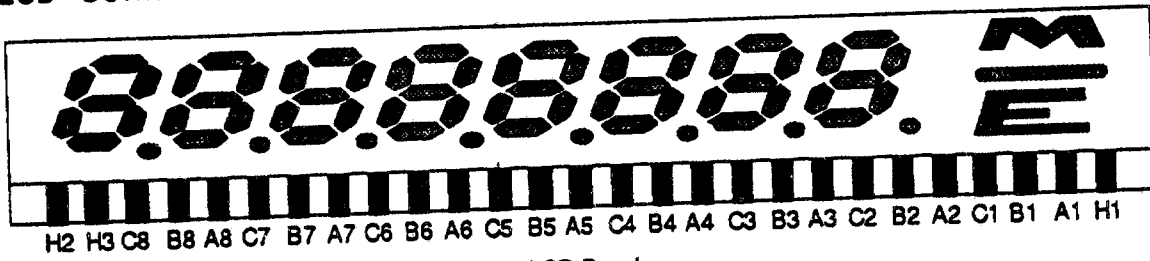

PIN DESCRIPTION

Pin No.	Signal	I/O	Description
1	VSB	1	Solar Battery
2	Vop	1	Option Pin
3	VDD		Power supply.
4	H1	O	Display output.
5	A1	O	Display output.
6	B1	O	Display output.
7	C1	O	Display output.
8	A2	O	Display output.
9	B2	O	Display output.
10	C2	O	Display output.
11	A3	O	Display output.
12	B3	O	Display output.
13	C3	O	Display output.
14	A4	O	Display output.
15	B4	O	Display output.
16	C4	O	Display output.
17	A5	O	Display output.
18	B5	O	Display output.
19	C5	O	Display output.
20	A6	O	Display output.
21	B6	O	Display output.
22	C6	O	Display output.
23	A7	O	Display output.

Pin No.	Signal	I/O	Description
24	B7	O	Display output.
25	C7	O	Display output.
26	A8	O	Display output.
27	B8	O	Display output.
28	C8	O	Display output.
29	H2	O	Display output.
30	H3	O	Display output.
31	GND		Ground.
32	VC	O	Cap terminal for voltage step-up.
33	VA	O	Cap terminal for voltage step-up.
34	VB	O	Cap terminal for voltage step-up.
35	CGin	I	Input terminal for CG.
36	K3	I	Key input.
37	K2	I	Key input.
38	A2X	O	Strobe output.
39	A3X	O	Strobe output.
40	A4X	O	Strobe output.
41	A5X	O	Strobe output.
42	P2	O	Strobe output.
43	P1	O	Strobe output.
44	K5	I	Key input.
45	K6	I	Key input.
46	K4	I	Key input.

APPLCIATION DIAGRAM

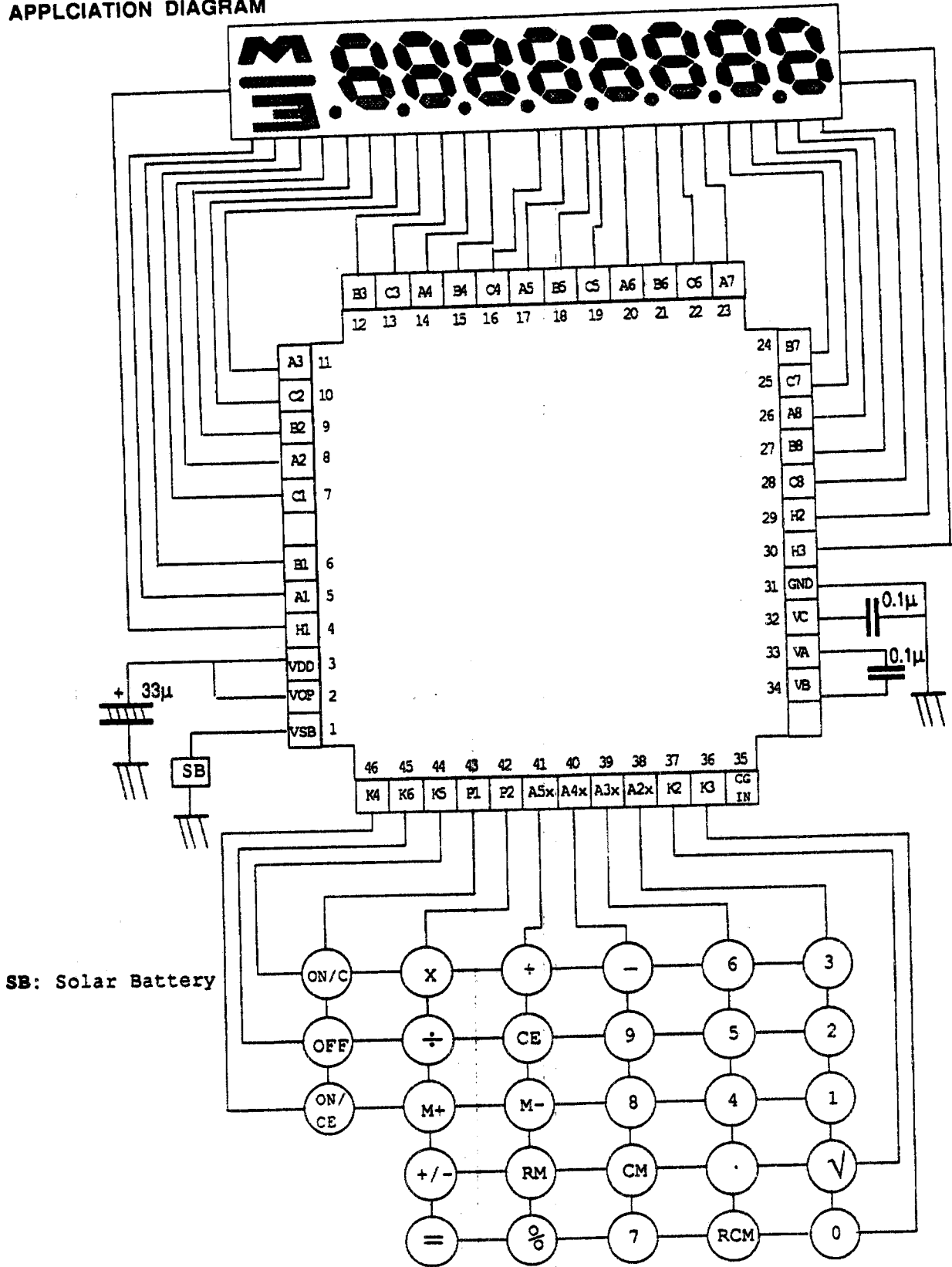

SB: Solar Battery

Note : Chip substract must be floating or connected to GND.

PAD DIAGRAM

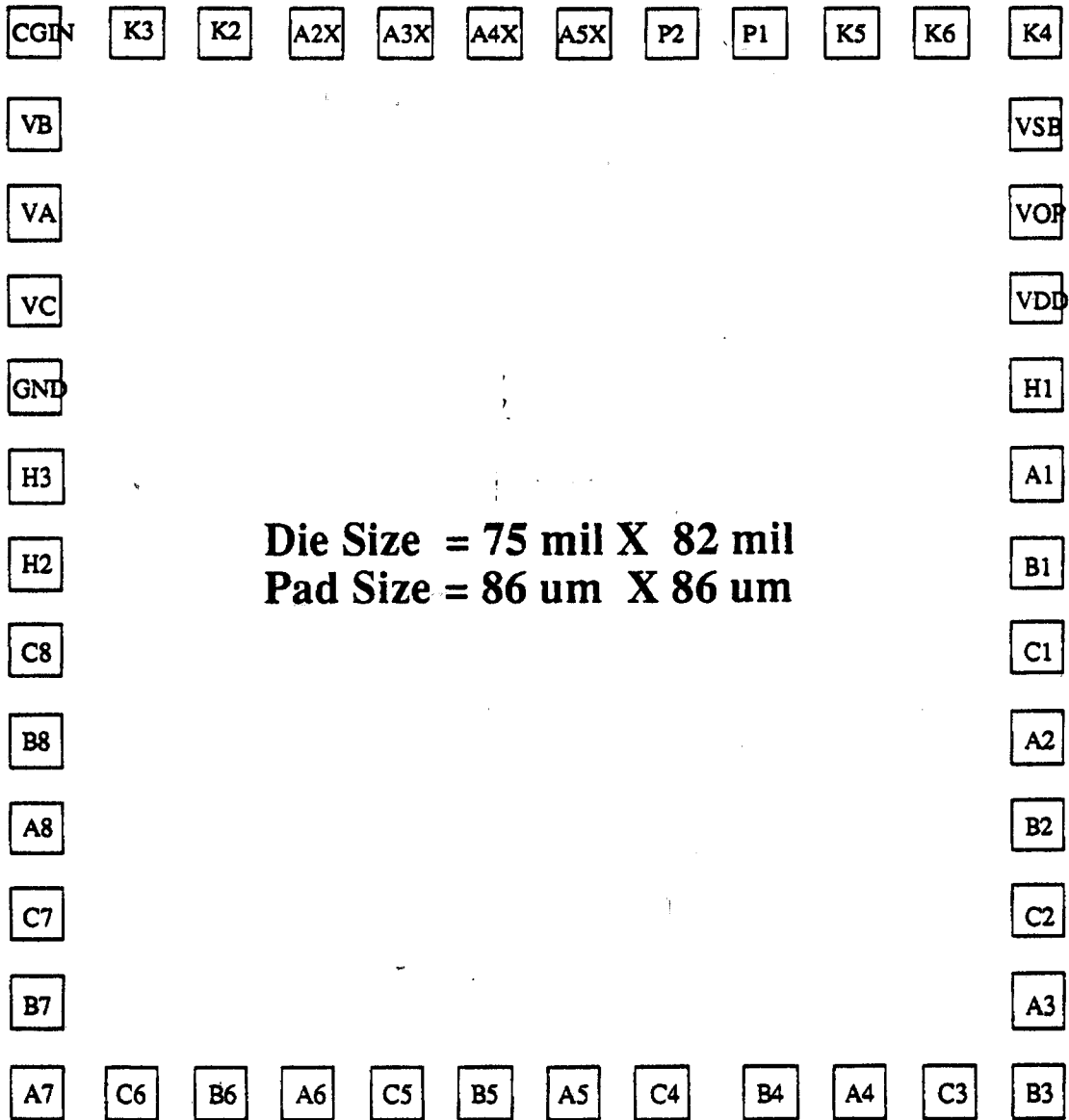

The Coordiante for Low Left Corner of Each Pad

A7(-869.0, -922.7)	A3 (782.9, -776.8)	K4 (782.9, 836.7)	VB (-869.0, 684.1)
C6(-713.1, -922.7)	C2 (782.9, -630.8)	K6 (628.6, 836.7)	VA (-869.0, 538.0)
B6(-567.0, -922.8)	B2 (782.9, -484.9)	K5 (481.1, 836.7)	VC (-869.0, 392.1)
A6(-420.9, -922.7)	A2 (782.9, -338.8)	P1 (331.8, 836.7)	GND(-869.0, 246.0)
C5(-274.6, -922.7)	C1 (782.9, -192.8)	P2 (184.8, 836.7)	H3 (-869.0, 100.1)
B5(-128.6, -922.7)	B1 (782.9, - 46.8)	A5X (37.8, 836.7)	H2 (-869.0, - 46.1)
A5(17.5, -922.7)	A1 (782.9, 99.2)	A4X (-109.2, 836.7)	C8 (-869.0, -192.2)
C4(163.4, -922.7)	H1 (782.9, 245.2)	A3X (-256.2, 836.7)	B8 (-869.0, -338.8)
B4(343.3, -922.7)	VDD(782.9, 391.1)	A2X (-403.2, 836.7)	A8 (-869.0, -484.7)
A4(489.5, -922.7)	VOP(782.9, 537.2)	K2 (-553.3, 836.7)	C7 (-869.0, -630.7)
C3(635.9, -922.8)	VS(782.9, 683.2)	K3 (-700.3, 836.7)	B7 (-869.0, -776.7)
B3(782.9, -922.8)		CGIN(-870.0, 836.7)	

欢迎索取免费详细资料、设计选型指南和光盘、样品；产品繁多未能尽录，欢迎来电查询。

[中国传感器科技信息网：HTTP://WWW.SENSOR-IC.COM/](http://WWW.SENSOR-IC.COM/)

[工控安防网：HTTP://WWW.PC-PS.NET/](http://WWW.PC-PS.NET/)

[消费电子专用电路网：HTTP://WWW.SUNSTARE.COM/](http://WWW.SUNSTARE.COM/)

E-MAIL：xjr5@163.com szss20@163.com

MSN：suns8888@hotmail.com

QQ: 195847376

地址：深圳市福田区福华路福庆街鸿图大厦 1602 室

电话：0755-83376549 83376489 83387030 83387016

传真：0755-83376182 83338339 邮编：518033 手机：(0)13902971329

深圳展销部：深圳华强北路赛格电子市场 2583 号 TEL/FAX：
0755-83665529 25059422

北京分公司：北京海淀区知春路 132 号中发电子大厦 3097 号

TEL：010-81159046 82615020 13501189838 FAX：010-82613476

上海分公司：上海市北京东路 668 号上海赛格电子市场 2B35 号

TEL：021-28311762 56703037 13701955389 FAX：021-56703037

西安分公司：西安高新开发区 20 所(中国电子科技集团导航技术研究所)
西安劳动南路 88 号电子商城二楼 D23 号

TEL：029-81022619 13072977981 FAX:029-88789382

成都：TEL:(0)13717066236

技术支持：0755-83394033 13501568376