

GaAs PHEMT MMIC LOW NOISE AMPLIFIER, 2 - 4 GHz

Typical Applications

The HMC609 is ideal for:

- Fixed Microwave
- Point-to-Multi-Point Radios
- Test & Measurement Equipment
- Radar & Sensors
- Military & Space

Functional Diagram

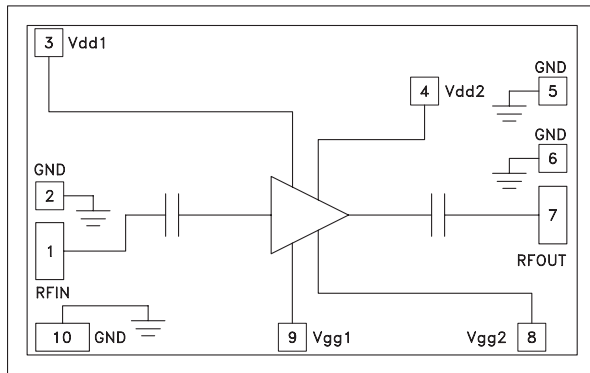

Features

- Excellent Gain Flatness: ± 0.2 dB
- High Gain: 20.5 dB
- Low Noise Figure: 3 dB
- Output IP3: +36 dBm
- Output P1dB: +22 dBm
- 50 Ohm Matched Input/Output
- Die Size: 2.1 x 1.3 x 0.1 mm

General Description

The HMC609 is a GaAs PHEMT MMIC Low Noise Amplifier (LNA) chip which operates from 2 to 4 GHz. The HMC609 features extremely flat performance characteristics including 20 dB of small signal gain, 3.0 dB of noise figure and output IP3 of +36 dBm across the operating band. This versatile LNA is ideal for hybrid and MCM assemblies due to its compact size, consistent output power and DC blocked RF I/O's. All data is measured with the chip in a 50 Ohm test fixture connected via two 0.025 mm (1 mil) diameter bondwires of minimal length 0.31 mm (12 mil).

Electrical Specifications, $T_A = +25^\circ C$, $V_{dd1} = V_{dd2} = +6V$, $I_{dd1} + I_{dd2} = 170 mA$ *

Parameter	Min.	Typ.	Max.	Units
Frequency Range		2 - 4		GHz
Gain	19	20.5		dB
Gain Variation Over Temperature		0.005	0.01	dB/°C
Noise Figure		3	4	dB
Input Return Loss		20		dB
Output Return Loss		17		dB
Output Power for 1 dB Compression (P1dB)	18	21		dBm
Saturated Output Power (Psat)		22		dBm
Output Third Order Intercept (IP3)		36		dBm
Supply Current (Idd1 + Idd2)		170	220	mA

*Adjust Vgg1 = Vgg2 between -1.5V to -0.5V (typ. -0.9V) to achieve total drain bias of 170mA

GaAs PHEMT MMIC LOW NOISE AMPLIFIER, 2 - 4 GHz

Broadband Gain & Return Loss

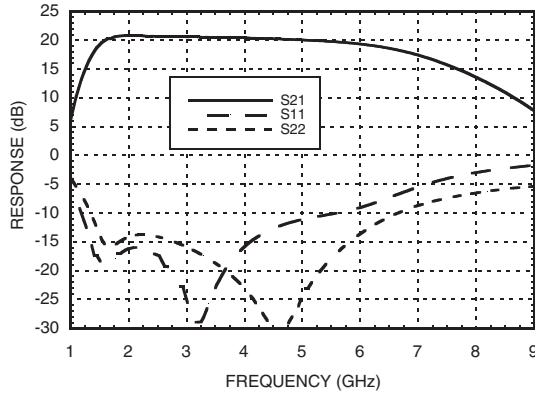

Gain vs. Temperature

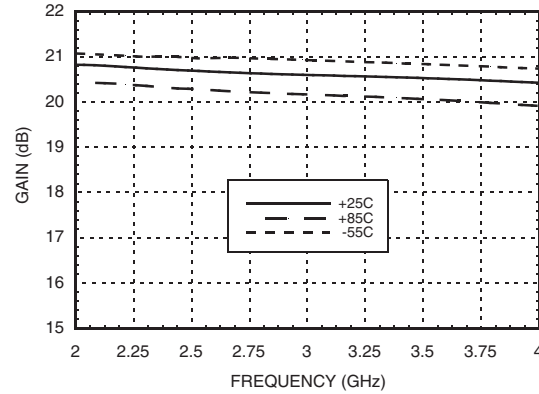

Input Return Loss vs. Temperature

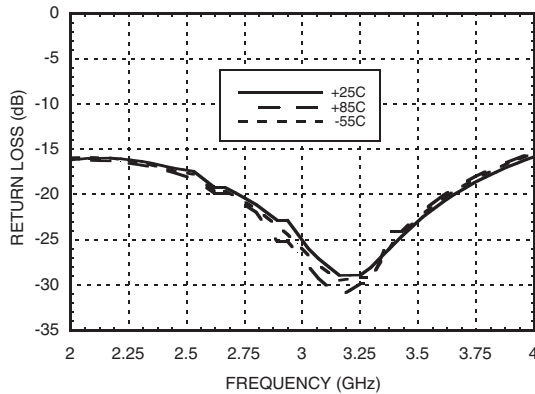

Output Return Loss vs. Temperature

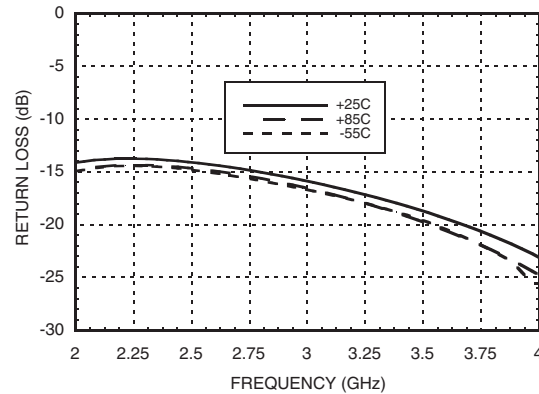

P1dB vs. Temperature

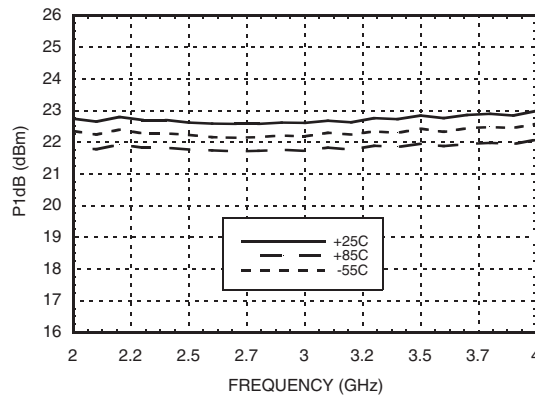

Psat vs. Temperature

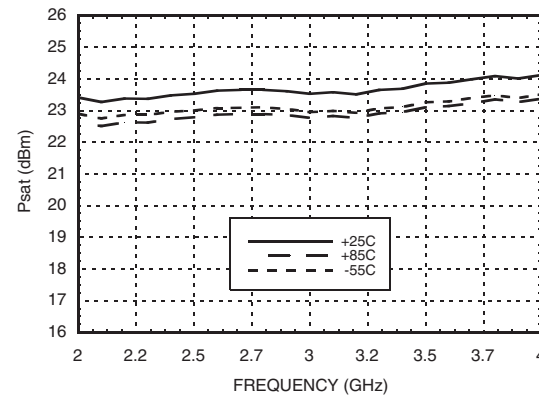

GaAs PHEMT MMIC LOW NOISE AMPLIFIER, 2 - 4 GHz

1

AMPLIFIERS - LOW NOISE - CHIP

Power Compression @ 3 GHz

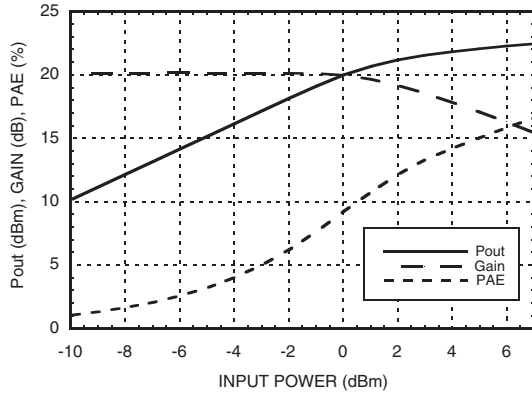

Output IP3 vs. Temperature

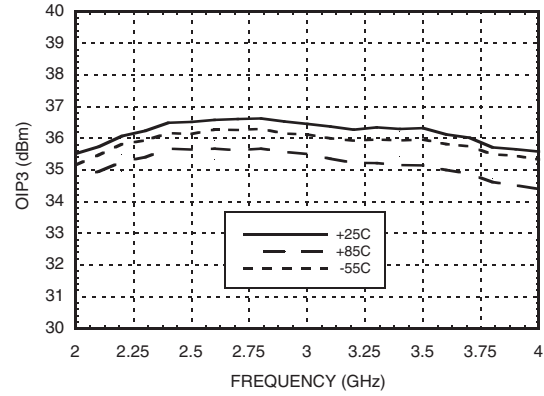

Noise Figure vs. Temperature

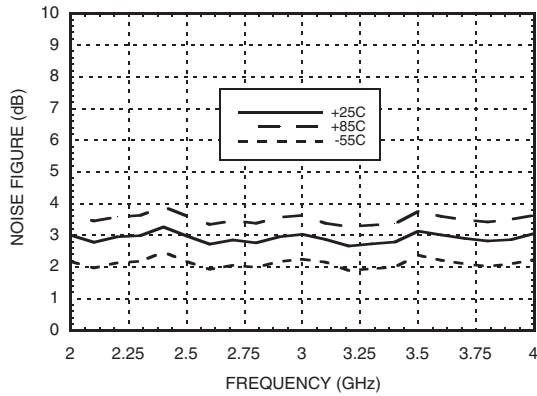

Reverse Isolation vs. Temperature

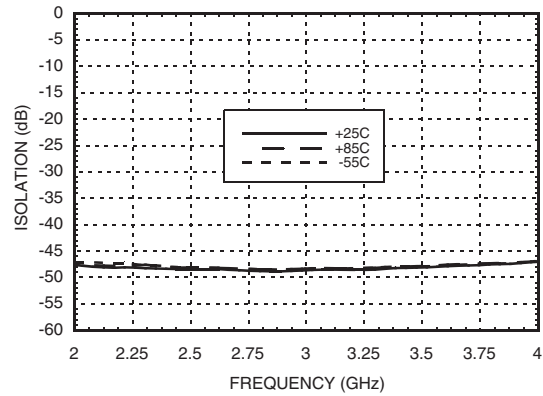

GaAs PHEMT MMIC LOW NOISE AMPLIFIER, 2 - 4 GHz

Absolute Maximum Ratings

Drain Bias Voltage (Vdd)	7 Vdc
RF Input Power (RFIN)(Vdd = +5 Vdc)	+15 dBm
Channel Temperature	175 °C
Continuous Pdiss (T = 85 °C) (derate 18 mW/°C above 85 °C)	1.64 W
Thermal Resistance (channel to ground pad)	55 °C/W
Storage Temperature	-65 to +150 °C
Operating Temperature	-55 to +85 °C

Typical Supply Current vs. Vdd

Vdd (V)	Idd (mA)
+5.5	160
+6.0	170
+6.5	180

Note: Amplifier will operate over full voltage range shown above



**ELECTROSTATIC SENSITIVE DEVICE
OBSERVE HANDLING PRECAUTIONS**

Outline Drawing

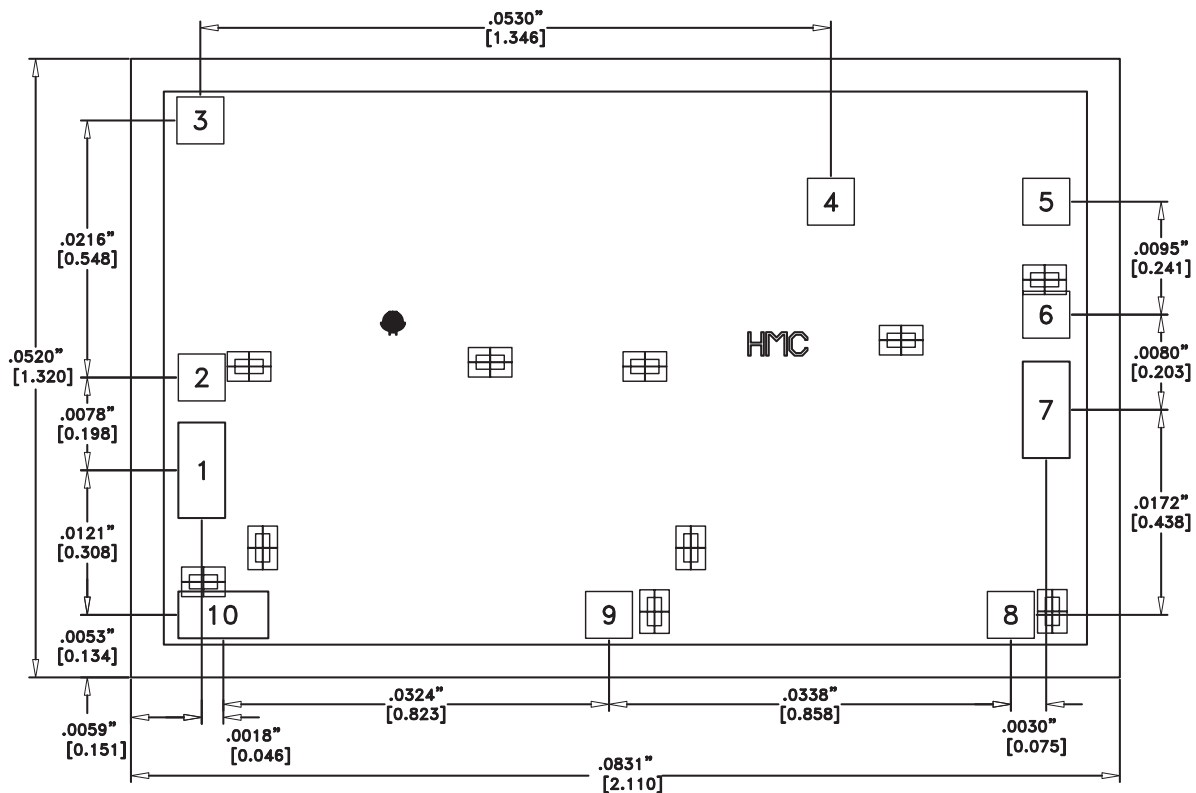

Die Packaging Information [1]

Standard	Alternate
GP-2 (Gel Pack)	[2]

[1] Refer to the "Packaging Information" section for die packaging dimensions.

[2] For alternate packaging information contact Hittite Microwave Corporation.

NOTES:

1. ALL DIMENSIONS IN INCHES [MILLIMETERS]
2. DIE THICKNESS IS 0.007"
3. TYPICAL BOND PAD IS 0.004" SQUARE
4. BACKSIDE METALLIZATION: GOLD
5. BACKSIDE METAL IS GROUND
6. BOND PAD METALIZATION: GOLD
7. NO CONNECTION REQUIRED FOR UNLABELED BOND PADS
8. OVERALL DIE SIZE ±0.002"



GaAs PHEMT MMIC LOW NOISE AMPLIFIER, 2 - 4 GHz

v03.0210

1

AMPLIFIERS - LOW NOISE - CHIP

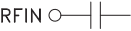
Pad Descriptions

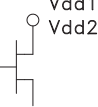
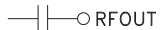
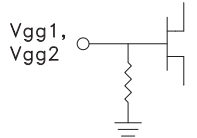
Pad Number	Function	Description	Interface Schematic
1	RFIN	This pad is AC coupled and matched to 50 Ohms.	RFIN 
2, 5, 6, 10 Die Bottom	GND	These pads & die bottom must be connected to RF/DC ground.	GND 
3, 4	Vdd1, Vdd2	Power Supply Voltage for the amplifier. External bypass capacitors of 100 pF & 0.1 μF are required.	Vdd1, Vdd2 
7	RFOUT	This pad is AC coupled and matched to 50 Ohms.	RFOUT 
8, 9	Vgg2, Vgg1	Gates supply voltage for the amplifier. External bypass capacitors of 100 pF and 0.1 μF are required.	Vgg1, Vgg2 

Assembly Diagram

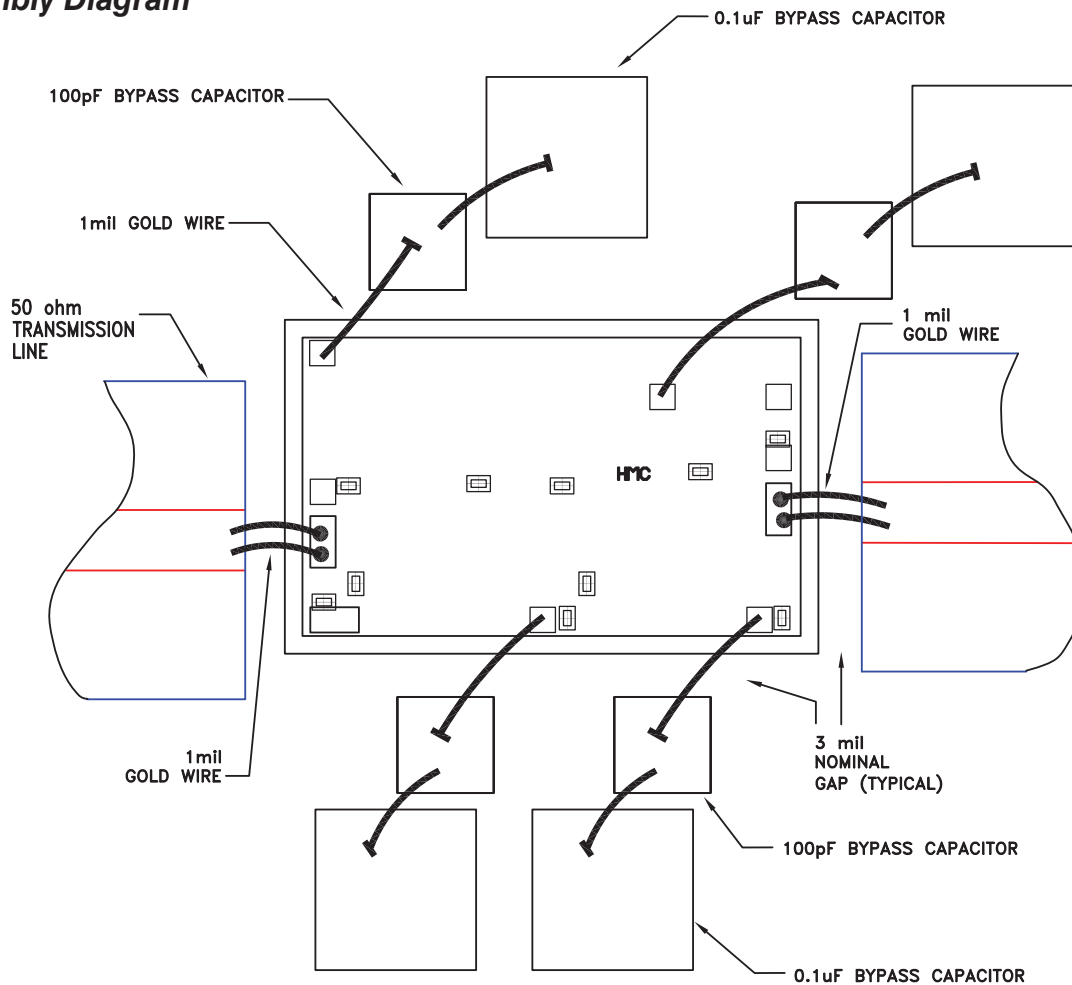

GaAs PHEMT MMIC LOW NOISE AMPLIFIER, 2 - 4 GHz

Mounting & Bonding Techniques for Millimeterwave GaAs MMICs

The die should be attached directly to the ground plane eutectically or with conductive epoxy (see HMC general Handling, Mounting, Bonding Note).

50 Ohm Microstrip transmission lines on 0.127mm (5 mil) thick alumina thin film substrates are recommended for bringing RF to and from the chip (Figure 1). If 0.254mm (10 mil) thick alumina thin film substrates must be used, the die should be raised 0.150mm (6 mils) so that the surface of the die is coplanar with the surface of the substrate. One way to accomplish this is to attach the 0.102mm (4 mil) thick die to a 0.150mm (6 mil) thick molybdenum heat spreader (moly-tab) which is then attached to the ground plane (Figure 2).

Microstrip substrates should be brought as close to the die as possible in order to minimize bond wire length. Typical die-to-substrate spacing is 0.076mm (3 mils).

Handling Precautions

Follow these precautions to avoid permanent damage.

Storage: All bare die are placed in either Waffle or Gel based ESD protective containers, and then sealed in an ESD protective bag for shipment. Once the sealed ESD protective bag has been opened, all die should be stored in a dry nitrogen environment.

Cleanliness: Handle the chips in a clean environment. DO NOT attempt to clean the chip using liquid cleaning systems.

Static Sensitivity: Follow ESD precautions to protect against > ± 250V ESD strikes.

Transients: Suppress instrument and bias supply transients while bias is applied. Use shielded signal and bias cables to minimize inductive pick-up.

General Handling: Handle the chip along the edges with a vacuum collet or with a sharp pair of bent tweezers. The surface of the chip has fragile air bridges and should not be touched with vacuum collet, tweezers, or fingers.

Mounting

The chip is back-metallized and can be die mounted with AuSn eutectic preforms or with electrically conductive epoxy. The mounting surface should be clean and flat.

Eutectic Die Attach: A 80/20 gold tin preform is recommended with a work surface temperature of 255 °C and a tool temperature of 265 °C. When hot 90/10 nitrogen/hydrogen gas is applied, tool tip temperature should be 290 °C. DO NOT expose the chip to a temperature greater than 320 °C for more than 20 seconds. No more than 3 seconds of scrubbing should be required for attachment.

Epoxy Die Attach: Apply a minimum amount of epoxy to the mounting surface so that a thin epoxy fillet is observed around the perimeter of the chip once it is placed into position. Cure epoxy per the manufacturer's schedule.

Wire Bonding

Ball or wedge bond with 0.025 mm (1 mil) diameter pure gold wire is recommended. Thermosonic wirebonding with a nominal stage temperature of 150 °C and a ball bonding force of 40 to 50 grams or wedge bonding force of 18 to 22 grams is recommended. Use the minimum level of ultrasonic energy to achieve reliable wirebonds. Wirebonds should be started on the chip and terminated on the package or substrate. All bonds should be as short as possible <0.31 mm (12 mils).

