

**US5682**

## Unipolar Hall Switch – High Sensitivity Inverted Output

### Features and Benefits

- Wide operating voltage range from 3.5V to 24V
- High sensitivity
- CMOS technology
- Chopper-stabilized amplifier stage
- Low current consumption
- Open drain output
- Inverted Output
- Thin SOT23 3L RoHS Compliant package

### Application Examples

- Automotive, Consumer and Industrial
- Solid-state switch
- Interrupter
- Current detector
- Proximity detection

### Ordering Code

Product Code	Temperature Code	Package Code	Option Code	Packing Form Code
US5682	E	SE	AAA-000	RE
US5682	K	SE	AAA-000	RE

#### Legend:

Temperature Code: E for Temperature Range -40°C to 85°C  
K for Temperature Range -40°C to 150°C

Package Code: SE for TSOT

Option Code: xxx-000: Standard version

Packing Form: RE for Reel

Ordering example: US5682ESE-AAA-000-RE

## 1 Functional Diagram

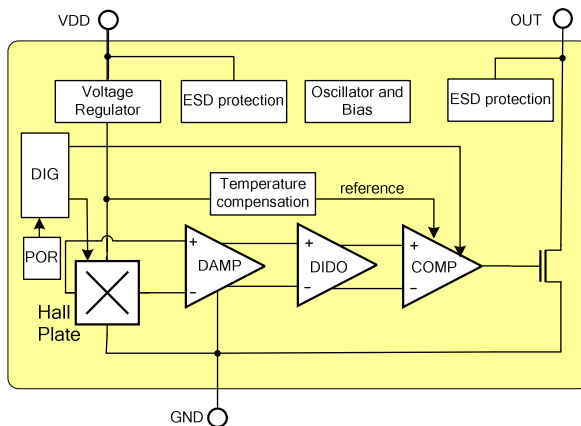

## 2 General Description

The Melexis US5682 is a unipolar Hall-effect switch designed in mixed signal CMOS technology.

The device integrates a voltage regulator, Hall sensor with advanced Correlated Double Sampling (CDS) offset cancellation system and an open-drain output driver, all in a single package.

Thanks to its wide operating voltage range and temperature range, it is suitable for use in automotive and solid state switch applications.

The device is delivered in a Thin Small Outline Transistor (TSOT) 3-lead RoHS compliant package.

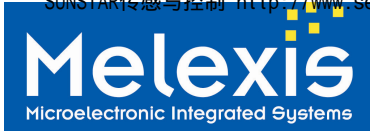

# US5682

## Unipolar Hall Switch – High Sensitivity Inverted Output

---

### Table of Contents

<b>1 Functional Diagram .....</b>	<b>1</b>
<b>2 General Description .....</b>	<b>1</b>
<b>3 Glossary of Terms .....</b>	<b>3</b>
<b>4 Absolute Maximum Ratings .....</b>	<b>3</b>
<b>5 Pin Definitions and Descriptions .....</b>	<b>3</b>
<b>6 General Electrical Specifications .....</b>	<b>4</b>
<b>7 Magnetic Specifications .....</b>	<b>4</b>
<b>8 Output Behaviour versus Magnetic Pole .....</b>	<b>5</b>
<b>9 Detailed General Description .....</b>	<b>5</b>
<b>10 Unique Features .....</b>	<b>5</b>
<b>11 Performance Graphs .....</b>	<b>6</b>
<b>12 Test Conditions .....</b>	<b>7</b>
<b>13 Application Information .....</b>	<b>8</b>
13.1 Typical Three-Wire Application Circuit .....	8
13.2 Two-Wire Circuit .....	8
13.3 Automotive and Harsh, Noisy Environments Three-Wire Circuit .....	8
<b>14 Application Comments .....</b>	<b>8</b>
<b>15 Standard information regarding manufacturability of Melexis products with different soldering processes .....</b>	<b>9</b>
<b>16 ESD Precautions .....</b>	<b>9</b>
<b>17 SE Package Information (TSOT-3L) .....</b>	<b>10</b>
<b>18 Disclaimer .....</b>	<b>11</b>

### 3 Glossary of Terms

MilliTesla (mT), Gauss	Units of magnetic flux density: 1mT = 10 Gauss
RoHS	Restriction of Hazardous Substances
TSOT	Thin Small Outline Transistor (TSOT package) – also referred with the Melexis package code “SE”
ESD	Electro-Static Discharge

### 4 Absolute Maximum Ratings

Parameter	Symbol	Value	Units
Supply Voltage	V <sub>DD</sub>	28	V
Supply Current	I <sub>DD</sub>	50	mA
Output Voltage	V <sub>OUT</sub>	28	V
Output Current	I <sub>OUT</sub>	50	mA
Operating Temperature Range	T <sub>A</sub>	-40 to 85	°C
Storage Temperature Range	T <sub>S</sub>	-50 to 150	°C
Maximum Junction Temperature	T <sub>J</sub>	165	°C

Table 1: Absolute maximum ratings

Exceeding the absolute maximum ratings may cause permanent damage. Exposure to absolute-maximum-rated conditions for extended periods may affect device reliability.

### 5 Pin Definitions and Descriptions

Pin No	Name	Type	Function
1	VDD	Supply	Supply Voltage pin
2	OUT	Output	Open Drain Output pin
3	GND	Ground	Ground pin

Table 2: Pin definitions and descriptions

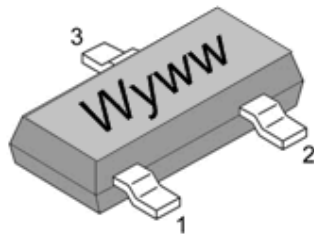

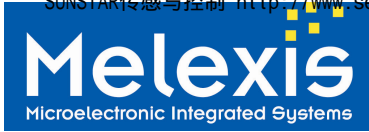
**US5682**

## Unipolar Hall Switch – High Sensitivity Inverted Output

### 6 General Electrical Specifications

DC Operating Parameters  $T_A = 25^\circ\text{C}$ ,  $V_{DD} = 12\text{V}$  (unless otherwise specified)

Parameter	Symbol	Test Conditions	Min	Typ	Max	Units
Supply Voltage	$V_{DD}$	Operating	3.5		24	V
Supply Current	$I_{DD}$	$B < B_{RP}$	0.5	2.5	5	mA
Output Saturation Voltage	$V_{DSon}$	$I_{OUT} = 20\text{mA}$ , $B < B_{RP}$		0.3	0.5	V
Output Leakage Current	$I_{OFF}$	$B > B_{OP}$ , $V_{OUT} = 24\text{V}$		0.01	10	$\mu\text{A}$
Output Rise Time	$t_r$	$R_L = 1\text{k}\Omega$ , $C_L = 20\text{pF}$		0.25		$\mu\text{s}$
Output Fall Time	$t_f$	$R_L = 1\text{k}\Omega$ , $C_L = 20\text{pF}$		0.25		$\mu\text{s}$
Maximum Switching Frequency	$F_{SW}$			5		KHz
Power-On Time <sup>1</sup>	$t_{ON}$				100	$\mu\text{s}$
Package Thermal Resistance	$R_{TH}$	Single layer (1S) Jedec board		301		$^\circ\text{C/W}$

Table 3: Electrical specifications

<sup>1</sup> The Power-On Time represents the time from reaching the power-on reset level to the first refresh of the output (first valid output state). Value according simulation only, not subject to production test.

### 7 Magnetic Specifications

DC Operating Parameters  $T_A = 25^\circ\text{C}$ ,  $V_{DD} = 12\text{V}$  (unless otherwise specified)

Parameter	Symbol	Test Conditions	Min	Typ	Max	Units
Operating Point	$B_{OP}$		3.8	5.5	7.2	mT
Release Point	$B_{RP}$		2	3.5	5	mT
Hysteresis	$B_{HYST}$		1.5	2	2.7	mT

Table 4: Magnetic specifications

DC Operating Parameters  $T_A = -40^\circ\text{C}$  to  $125^\circ\text{C}$  (K-version),  $T_A = -40^\circ\text{C}$  to  $85^\circ\text{C}$  (E-version),  $V_{DD} = 12\text{V}$ 

Parameter	Symbol	Test Conditions	Min	Typ	Max	Units
Operating Point	$B_{OP}$		3.4		7.7	mT
Release Point	$B_{RP}$		1.8		5.4	mT
Hysteresis	$B_{HYST}$		1		2.8	mT

Table 5: Magnetic specifications

### 8 Output Behaviour versus Magnetic Pole

DC Operating Parameters  $T_A = -40^{\circ}\text{C}$  to  $125^{\circ}\text{C}$ ,  $V_{DD} = 3.5\text{V}$  to  $24\text{V}$  (unless otherwise specified)

Parameter	Test Conditions	OUT
South pole	$B > B_{OP}$	High
Null or weak magnetic field	$B \rightarrow 0$ or $B < B_{RP}$	Low
North pole	$B > B_{OP}$	Low

Table 6: Output behaviour versus magnetic pole

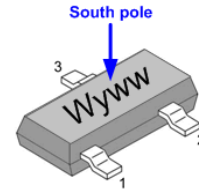

OUT = High ( $\approx V_{PU}$ )

### 9 Detailed General Description

Based on mixed signal CMOS technology, Melexis US5682 is a Hall-effect device with high magnetic sensitivity and inverted output. Its sensitivity enables high accuracy in position sensing by the use of small air gap.

The Correlated Double Sampling (CDS) technique suppresses the offset generally observed with Hall sensors and amplifiers. The CMOS technology makes this advanced technique possible and contributes to smaller chip size and lower current consumption than bipolar technology. The small chip size is also an important factor to minimize the effect of physical stress. This combination results in more accurate and stable magnetic characteristics, and enables faster and more precise design.

The wide operating voltage from 3.5V to 24V and low current consumption make this device especially suitable for solid state switch applications.

The output signal is open-drain type. Such output allows simple connectivity with TTL or CMOS logic by using a pull-up resistor tied between a pull-up voltage and the device output.

### 10 Unique Features

The US5682 exhibits unipolar magnetic switching characteristics. Therefore, it operates only with one magnetic pole.

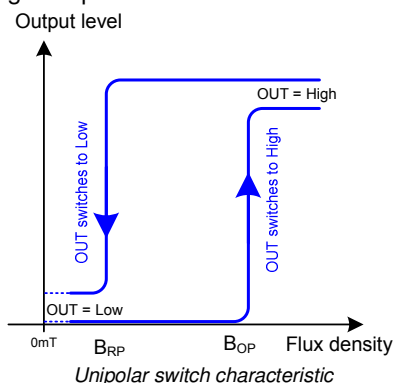

The US5682 device is inverted output, south pole active: Applying a south magnetic pole greater than  $B_{OP}$  facing the branded side of the package switches the output high.

Removing the magnetic field ( $B \rightarrow 0$ ) switches the output low. The use of the opposite magnetic pole facing the branded side does not affect the output state.

A magnetic hysteresis  $B_{HYST}$  keeps  $B_{OP}$  and  $B_{RP}$  separated by a minimal value. This hysteresis prevents output oscillation near the switching point.

### 11 Performance Graphs

#### 11.1 Magnetic parameters vs. $T_A$

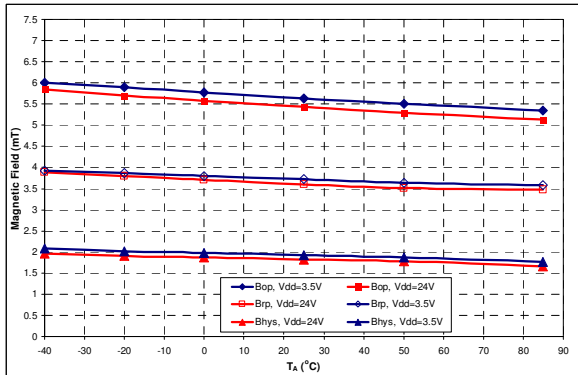

#### 11.2 Magnetic parameters vs. $V_{DD}$

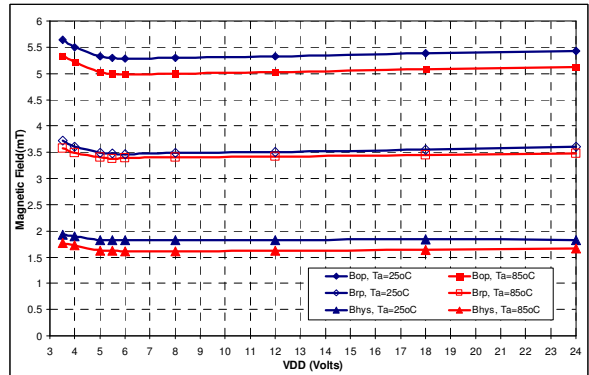

#### 11.3 $V_{DSon}$ vs. $T_A$

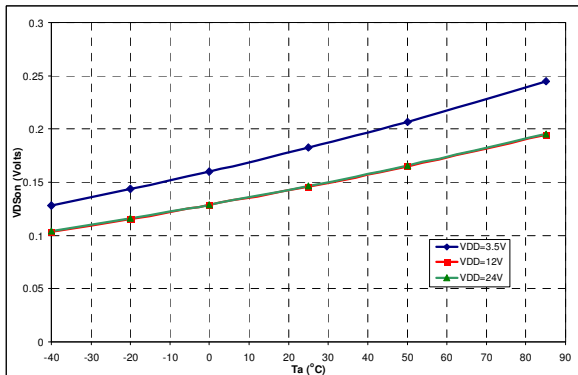

#### 11.4 $V_{DSon}$ vs. $V_{DD}$

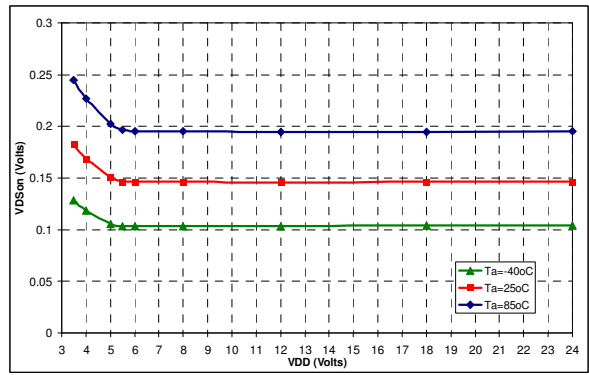

#### 11.5 $I_{DD}$ vs. $T_A$

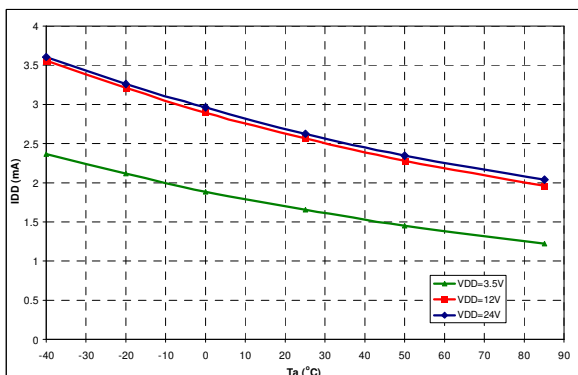

#### 11.6 $I_{DD}$ vs. $V_{DD}$

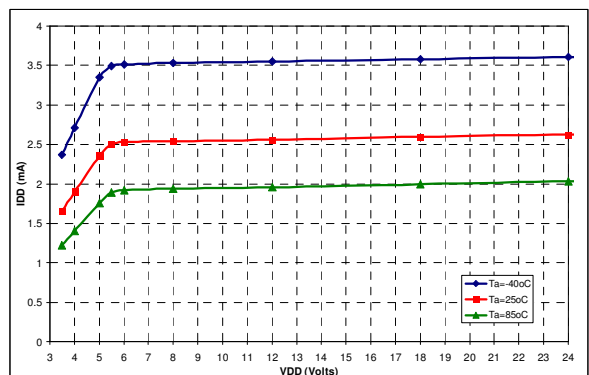

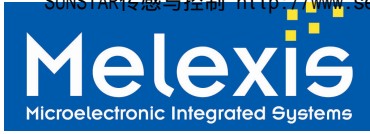

# US5682

## Unipolar Hall Switch – High Sensitivity Inverted Output

### 11.7 $I_{OFF}$ vs. $T_A$

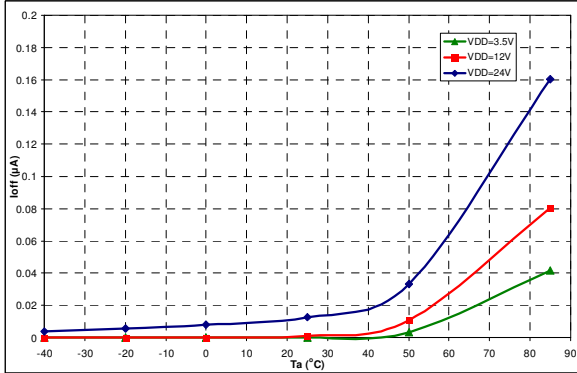

### 11.8 $I_{OFF}$ vs. $V_{DD}$

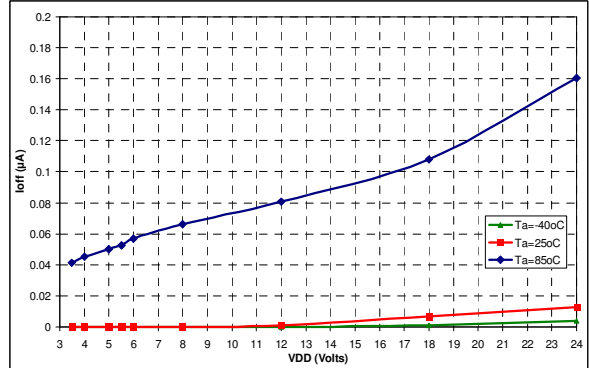

## 12 Test Conditions

Note : DUT = Device Under Test

### 12.1 Supply Current

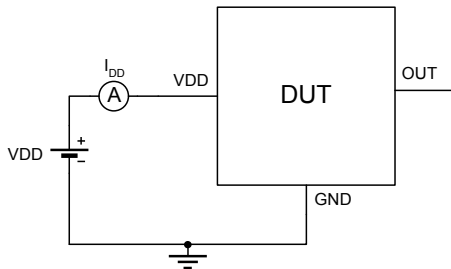

Note 1 - The supply current  $I_{DD}$  represents the static supply current. OUT is left open during measurement.

Note 2 - The device is put under magnetic field with  $B < B_{RP}$ .

### 12.3 Output Leakage Current

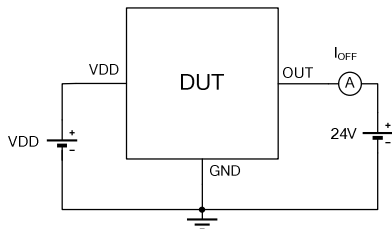

Note 1 - The device is put under magnetic field with  $B > B_{OP}$ .

### 12.2 Output Saturation Voltage

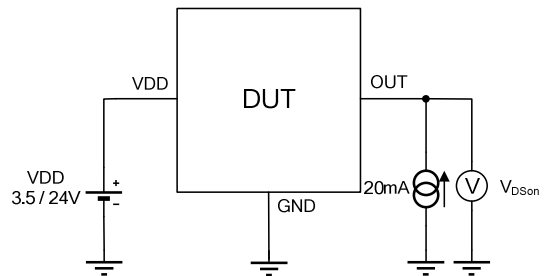

Note 1 - The output saturation voltage  $V_{DSon}$  is measured at  $V_{DD} = 3.5V$  and  $V_{DD} = 24V$ .

Note 2 - The device is put under magnetic field with  $B < B_{RP}$ .

### 12.4 Magnetic Thresholds

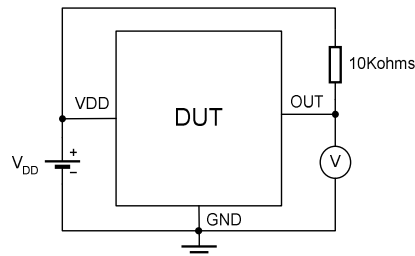

Note 1 -  $B_{OP}$  is determined by putting the device under magnetic field swept from  $B_{RPmin}$  up to  $B_{OPmax}$  until the output is switched on.

Note 2 -  $B_{RP}$  is determined by putting the device under magnetic field swept from  $B_{OPmax}$  down to  $B_{RPmin}$  until the output is switched off.

## 13 Application Information

### 13.1 Typical Three-Wire Application Circuit

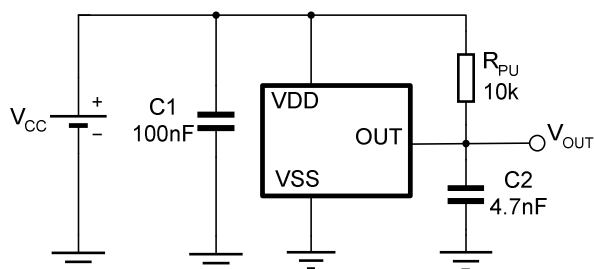

### 13.2 Two-Wire Circuit

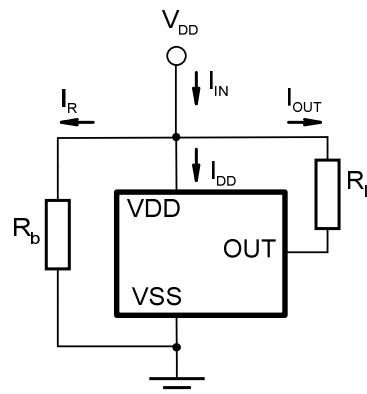

Note:

With this circuit, precise ON and OFF currents can be detected using only two connecting wires.

The resistors  $R_L$  and  $R_b$  can be used to bias the input current. Refer to the part specifications for limiting values.

$$B_{RP} : I_{OFF} = I_R + I_{DD} = V_{DD}/R_b + I_{DD}$$

$$B_{OP} : I_{ON} = I_{OFF} + I_{OUT} = I_{OFF} + V_{DD}/R_L$$

### 13.3 Automotive and Harsh, Noisy Environments Three-Wire Circuit

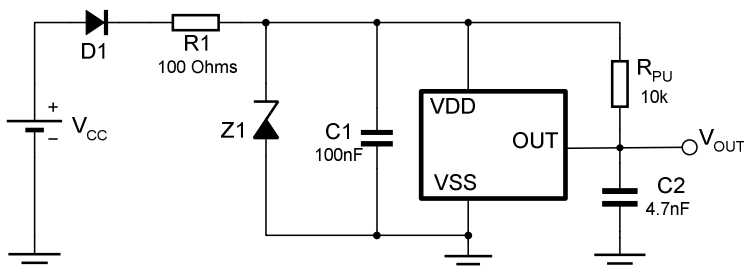

## 14 Application Comments

For proper operation, a 100nF bypass capacitor should be placed as close as possible to the device between the  $V_{DD}$  and ground pin.

For reverse voltage protection, it is recommended to connect a resistor or a diode in series with the  $V_{DD}$  pin. When using a resistor, three points are important:

- the resistor has to limit the reverse current to 50mA maximum ( $V_{CC} / R1 \leq 50mA$ )
- the resulting device supply voltage  $V_{DD}$  has to be higher than  $V_{DD}$  min ( $V_{DD} = V_{CC} - R1 \cdot I_{DD}$ )
- the resistor has to withstand the power dissipated in reverse voltage condition ( $P_D = V_{CC}^2 / R1$ )

When using a diode, a reverse current cannot flow and the voltage drop is almost constant ( $\approx 0.7V$ ).

Therefore, a 100 $\Omega$ /0.25W resistor for 5V application and a diode for higher supply voltage are recommended. Both solutions provide the required reverse voltage protection.

When a weak power supply is used or when the device is intended to be used in noisy environment, it is recommended that figure 13.3 from the Application Information section is used.

The low-pass filter formed by  $R1$  and  $C1$  and the zener diode  $Z1$  bypass the disturbances or voltage spikes occurring on the device supply voltage  $V_{DD}$ . The diode  $D1$  provides additional reverse voltage protection.

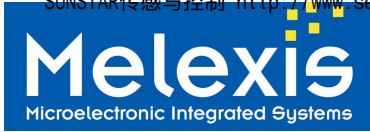

**US5682****Unipolar Hall Switch – High Sensitivity  
Inverted Output**

---

## **15 Standard information regarding manufacturability of Melexis products with different soldering processes**

Our products are classified and qualified regarding soldering technology, solderability and moisture sensitivity level according to following test methods:

### **Reflow Soldering SMD's (Surface Mount Devices)**

- IPC/JEDEC J-STD-020  
Moisture/Reflow Sensitivity Classification for Nonhermetic Solid State Surface Mount Devices (classification reflow profiles according to table 5-2)
- EIA/JEDEC JESD22-A113  
Preconditioning of Nonhermetic Surface Mount Devices Prior to Reliability Testing (reflow profiles according to table 2)

### **Wave Soldering SMD's (Surface Mount Devices) and THD's (Through Hole Devices)**

- EN60749-20  
Resistance of plastic- encapsulated SMD's to combined effect of moisture and soldering heat
- EIA/JEDEC JESD22-B106 and EN60749-15  
Resistance to soldering temperature for through-hole mounted devices

### **Iron Soldering THD's (Through Hole Devices)**

- EN60749-15  
Resistance to soldering temperature for through-hole mounted devices

### **Solderability SMD's (Surface Mount Devices) and THD's (Through Hole Devices)**

- EIA/JEDEC JESD22-B102 and EN60749-21  
Solderability

For all soldering technologies deviating from above mentioned standard conditions (regarding peak temperature, temperature gradient, temperature profile etc) additional classification and qualification tests have to be agreed upon with Melexis.

The application of Wave Soldering for SMD's is allowed only after consulting Melexis regarding assurance of adhesive strength between device and board.

Melexis is contributing to global environmental conservation by promoting **lead free** solutions. For more information on qualifications of **RoHS** compliant products (RoHS = European directive on the Restriction Of the use of certain Hazardous Substances) please visit the quality page on our website:

<http://www.melexis.com/quality.aspx>

## **16 ESD Precautions**

Electronic semiconductor products are sensitive to Electro Static Discharge (ESD). Always observe Electro Static Discharge control procedures whenever handling semiconductor products.

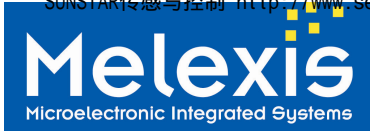

# US5682

## Unipolar Hall Switch – High Sensitivity Inverted Output

### 17 SE Package Information (TSOT-3L)

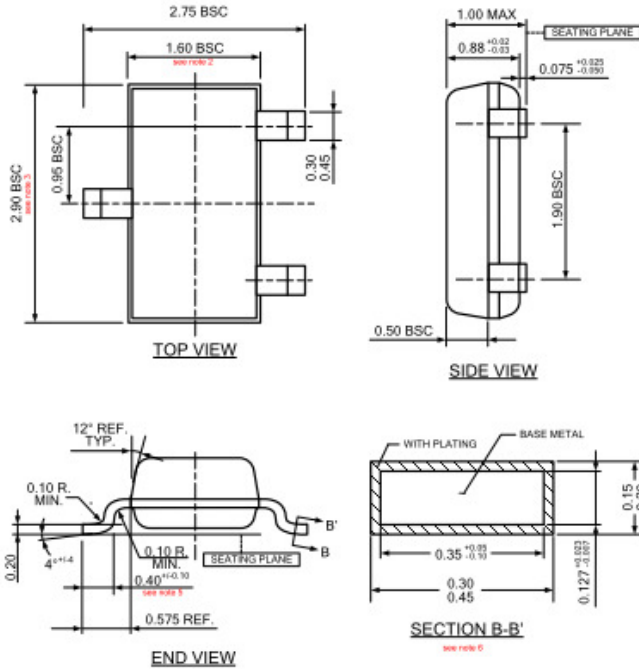

**Notes:**

1. All dimensions are in millimeters
2. Outermost plastic extreme width does not include mold flash or protrusions. Mold flash and protrusions shall not exceed 0.15mm per side.
3. Outermost plastic extreme length does not include mold flash or protrusions. Mold flash and protrusions shall not exceed 0.25mm per side.
4. The lead width dimension does not include dambar protrusion. Allowable dambar protrusion shall be 0.07mm total in excess of the lead width dimension at maximum material condition.
5. Dimension is the length of terminal for soldering to a substrate.
6. Dimension on SECTION B-B' applies to the flat section of the lead between 0.08mm and 0.15mm from the lead tip.
7. Formed lead shall be planar with respect to one another with 0.076mm at seating plane.

**Marking:**

TBD

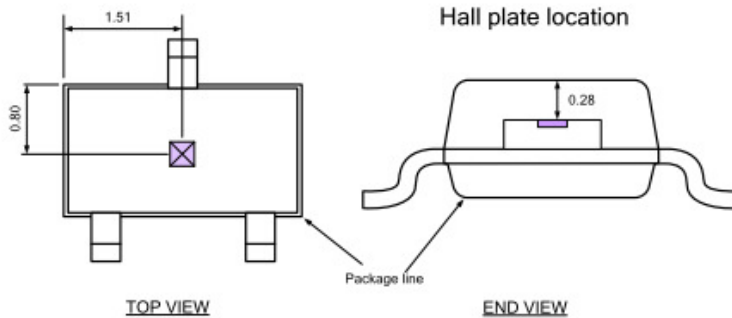

**Notes:**

1. All dimensions are in millimeters

c.

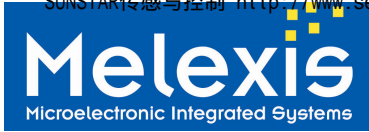

# US5682

## Unipolar Hall Switch – High Sensitivity Inverted Output

---

### 18 Disclaimer

Devices sold by Melexis are covered by the warranty and patent indemnification provisions appearing in its Term of Sale. Melexis makes no warranty, express, statutory, implied, or by description regarding the information set forth herein or regarding the freedom of the described devices from patent infringement. Melexis reserves the right to change specifications and prices at any time and without notice. Therefore, prior to designing this product into a system, it is necessary to check with Melexis for current information. This product is intended for use in normal commercial applications. Applications requiring extended temperature range, unusual environmental requirements, or high reliability applications, such as military, medical life-support or life-sustaining equipment are specifically not recommended without additional processing by Melexis for each application.

The information furnished by Melexis is believed to be correct and accurate. However, Melexis shall not be liable to recipient or any third party for any damages, including but not limited to personal injury, property damage, loss of profits, loss of use, interrupt of business or indirect, special incidental or consequential damages, of any kind, in connection with or arising out of the furnishing, performance or use of the technical data herein. No obligation or liability to recipient or any third party shall arise or flow out of Melexis' rendering of technical or other services.

© 2012 Melexis NV. All rights reserved.

For the latest version of this document, go to our website at  
**[www.melexis.com](http://www.melexis.com)**

Or for additional information contact Melexis Direct:

Europe, Africa, Asia:  
Phone: +32 1367 0495  
E-mail: [sales\\_europe@melexis.com](mailto:sales_europe@melexis.com)

America:  
Phone: +1 248 306 5400  
E-mail: [sales\\_usa@melexis.com](mailto:sales_usa@melexis.com)

ISO/TS 16949 and ISO14001 Certified