

NEC

MINIATURE SIGNAL RELAY EC2 SERIES

COMPACT AND LIGHTWEIGHT, SMALL MOUNTING SIZE,
HIGH BREAKDOWN VOLTAGE

DESCRIPTION

The EC2 series has reduced mounting space but sustained high-performance of NEC EA2 series. Furthermore, it complies with 2500 V surge-voltage requirement of Bellcore specification.

FEATURES

- Compact and light weight
- 2 form c contact arrangement
- Low power consumption
- Reduced mounting space : 15 mm × 7.5 mm
- High-breakdown voltage of coil to contacts :
1500 Vac, 2500 V (rise time : 2 μ s, fall time : 10 μ s)
- Capable of High-power switching :
700 Vac, 4.2 A, 4 times in case of accident
- UL recognized (E73266), CAS certified (LR46266)

APPLICATIONS

Electronic switching systems, PBX, terminal equipment, telephone systems.

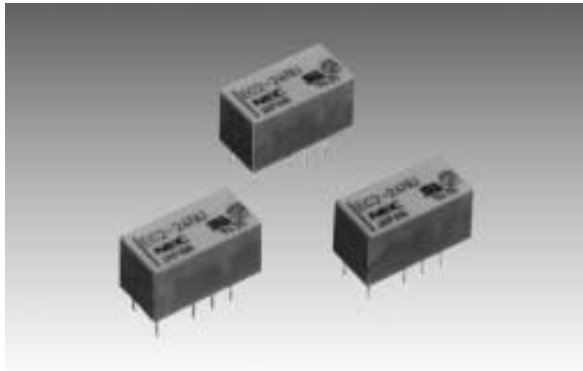

For Right Use of Miniature Relays

DO NOT EXCEED MAXIMUM RATINGS.

Do not use relays under exceeding conditions such as over ambient temperature, over voltage and over current. Incorrect use could result in abnormal heating, damage to related parts or cause burning.

READ CAUTIONS IN THE SELECTION GUIDE.

Read the cautions described in NEC's "Miniature Relays" (ER0046EJ*) when you choose relays for your application.

OUTLINE DRAWING AND DIMENSIONS

PAD LAYOUT (bottom view)

Unit : mm (inch)

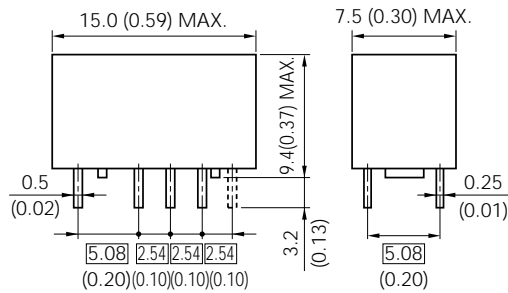

Non-latch and Single coil latch

Double coil latch

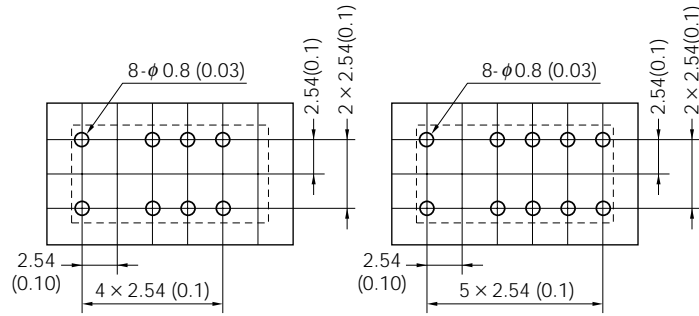

Note. General tolerance : ± 0.2 (± 0.008)
Dimensions in show basic size.
NJ type : Leads-2.8 mm (0.11)

Note. General tolerance : ± 0.1 (± 0.004)

MARKINGS

Standard type

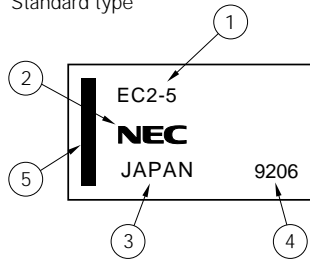

- ① Part number
- ② Manufacturer
- ③ Country of origin
- ④ Date code
- ⑤ Index mark of relay direction (pin No. 1, 12)
- ⑥ UL, CSA Marking

UL recognized,
CSA certified type

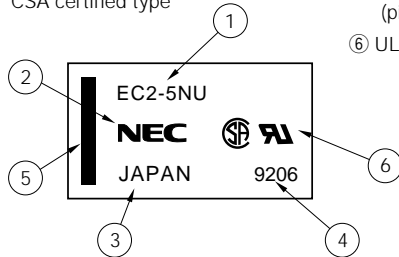

SAFETY STANDARD AND RATING

| | |
|---|---|
| UL Recognized (UL508)* File No E73266 | CSA Certified (CSA C22.2 No 14) File No LR46266 |
| 30 Vdc, 2A (Resistive) | |
| 110 Vdc, 0.3A (Resistive) | |
| 125 Vdc, 0.5A (Resistive) | |

* Spacing : UL114, UL478

| |
|--|
| TUV Certificate (EN60255 / IEC60255) |
| No. R 9751153 (Nonlatch and Single-coil-latch) |
| Creepage and clearance of coil to contact is more than 2 mm. (According EN60950) |
| Basic insulation class |

PIN CONFIGURATIONS (bottom view)

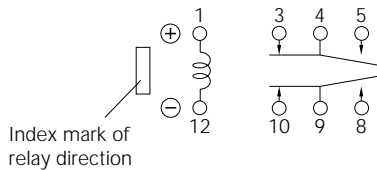

Non-latch type
(not energized position)

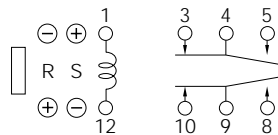

Single coil latch type
(reset position)

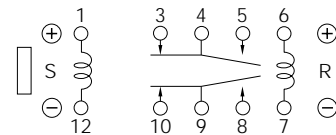

Double coil latch type
(reset position)

S : Coil polarity of set (operate)
R : Coil polarity of reset (release)

PART NUMBER SYSTEM

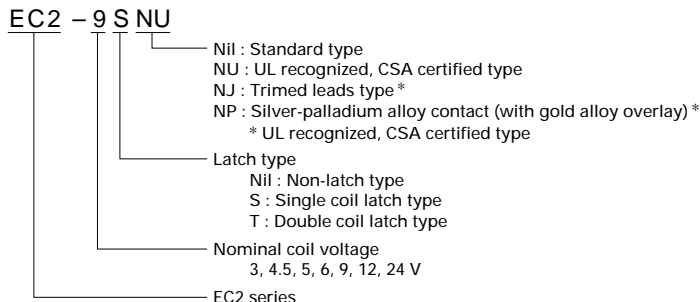

PERFORMANCE CHARACTERISTICS

| | | | |
|--------------------------------------|---------------------------|--|---|
| Contact Form | | 2 Form c | |
| Contact Material | | Silver alloy with gold alloy overlay | |
| Contact Ratings (UL / CSA Rating) | Maximum Switching Power | 60 W, 125 VA | |
| | Maximum Switching Voltage | 220 Vdc, 250 Vac | |
| | Maximum Switching Current | 2 A | |
| | Maximum Carrying Current | 2 A | |
| Minimum Contact Ratings | | 10 mVdc, 10 μ A *1 | |
| Initial Contact Resistance | | 50 m Ω typ. (Initial) | |
| Nominal Operating Power | Non-Latch Type | 140 mW (3 to 12 V), 200 mW (24 V) | |
| | Single Coil Latch Type | 100 mW | |
| | Single Coil Latch Type | 140 mW | |
| Operate Time (Excluding Bounce) | | Approx. 2 ms | |
| Release Time (Excluding Bounce) | | Approx. 1 ms without diode | |
| Insulation Resistance | | 1000 M Ω at 500 Vdc | |
| Breakdown Voltage | Between Open Contacts | 1000 Vac (for one minute) | |
| | Between Adjacent Contacts | 1500 V surge (10 \times 160 μ s *2) | |
| | Between Coil and Contact | 1500 Vac (for one minute) 2500 V surge, (2 \times 10 μ s *3) | Double Coil 1000 Vac (for one minute) Latch type 1500 V surge (10 \times 160 μ s *2) |
| Shock Resistance | | 735 m / s ² (misoperating) 980 m / s ² (destructive failure) | |
| Vibration Resistance | | 10 to 55 Hz double amplitude of 3 mm (misoperating) 10 to 55 Hz, double amplitude of 5 mm (Destructive failure) | |
| Ambient Temperature | | -40 to 85°C | |
| Coil Temperature Rise | | 18 degrees at nominal coil voltage (140 mW) | |
| Running specifications | No-load | 1 \times 10 ⁸ *4 operations (Non-latch type) 1 \times 10 ⁷ operations (latch type) | |
| | Load | 50 Vdc, 0.1 A (resistive) 1 \times 10 ⁶ operations at 85°C, 2 Hz | |
| | | 10 Vdc, 10 mA (resistive) 1 \times 10 ⁶ operations at 85°C, 2 Hz | |
| Weight | | Approx. 1.9 g | |

*1 This value is reference value in the resistance load.
Minimum capacity changes depending on switching frequency and environment temperatur and the load.

*2 rise time : 10 μ s, fall time : 160 μ s

*3 rise time : 2 μ s, fall time : 10 μ s

*4 This shows a number of operation where it can be running by which a fatal defect is not caused, and a number of operation by which a steady characteristic is maintained is 1 \times 10⁷ times.

Recommended relay drive conditions

Drive under conditions. If it is impossible, please inquire to NEC.

| | | |
|--|--|-------------------------------------|
| Nonlatch type | Voltage: within \pm 5% at nominal voltage | Ambient temperature -40 to +85°C |
| Single coil latch type Double coil latch type | Square pulse (rise and fall time is rapidly) | |
| | Pulse height : within \pm 5% at nominal voltage Pulse width : More than 10 ms | |

PRODUCT LINEUP

Non-latch Type

at 20°C

| Nominal Coil Voltage (Vdc) | Coil Resistance (Ω) ±10 % | Must Operate Voltage (Vdc) | Must Release Voltage (Vdc) |
|----------------------------|---------------------------|----------------------------|----------------------------|
| 3 | 64.3 | 2.25 | 0.3 |
| 4.5 | 145 | 3.38 | 0.45 |
| 5 | 178 | 3.75 | 0.5 |
| 6 | 257 | 4.5 | 0.6 |
| 9 | 579 | 6.75 | 0.9 |
| 12 | 1028 | 9 | 1.2 |
| 24 | 2880 | 18 | 2.4 |

Single-Coil Latch Type

at 20°C

| Nominal Coil Voltage (Vdc) | Coil Resistance (Ω) ±10 % | Must Operate Voltage (Vdc) | Must Release Voltage (Vdc) |
|----------------------------|---------------------------|----------------------------|----------------------------|
| 3 | 90 | 2.25 | 2.25 |
| 4.5 | 202.5 | 3.38 | 3.38 |
| 5 | 250 | 3.75 | 3.75 |
| 6 | 360 | 4.5 | 4.5 |
| 9 | 810 | 6.75 | 6.75 |
| 12 | 1440 | 9 | 9 |
| 24 | 5760 | 18 | 18 |

Double-Coil Latch Type ** (Can not be driven by reverse polarity for reverse operation.)

at 20°C

| Nominal Coil Voltage (Vdc) | Coil Resistance (Ω) ±10 % | | Must Operate Voltage (Vdc) | Must Release Voltage (Vdc) |
|----------------------------|---------------------------|------|----------------------------|----------------------------|
| | S | R | | |
| 3 | S | 64.3 | 2.25 | - |
| | R | 64.3 | - | 2.25 |
| 4.5 | S | 145 | 3.38 | - |
| | R | 145 | - | 3.38 |
| 5 | S | 178 | 3.75 | - |
| | R | 178 | - | 3.75 |
| 6 | S | 257 | 4.5 | - |
| | R | 257 | - | 4.5 |
| 9 | S | 579 | 6.75 | - |
| | R | 579 | - | 6.75 |
| 12 | S | 1028 | 9 | - |
| | R | 1028 | - | 9 |
| 24 | S | 4114 | 18 | - |
| | R | 4114 | - | 18 |

Note * Test by pulse voltage

** S : Set coil (pin No.1...⊕, pin No.5...⊖) R: Reset coil (pin No.10...⊕, pin No.6...⊖)

The latch type relays should be initialized at appointed position before using, and should be energized to specific polarity by a bone polabity to avoid wrong operation.

Any special coil requirement, please contact NEC for availability.

PERFORMANCE DATA

■ COIL TEMPERATURE RISE

Temperature is measured by coil resistance.

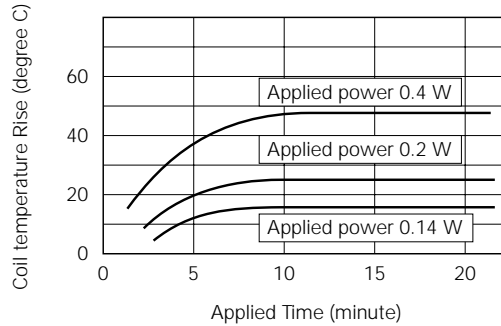
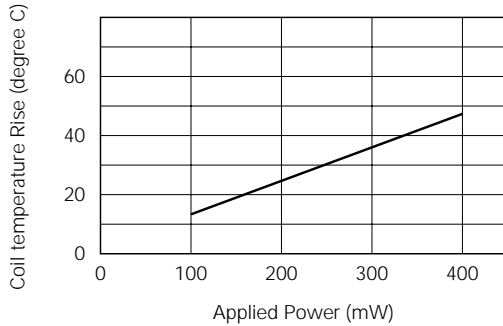

■ SWITCHING CAPACITY

This is allowed maximum value. Inquiry for NEC under maximum value at continuous use.

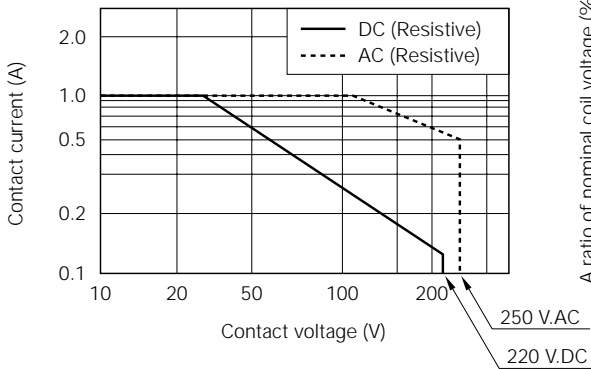

■ MAXIMUM COIL VOLTAGE

This is maximum value of permissible alteration. Inquiry for NEC at continuous use.

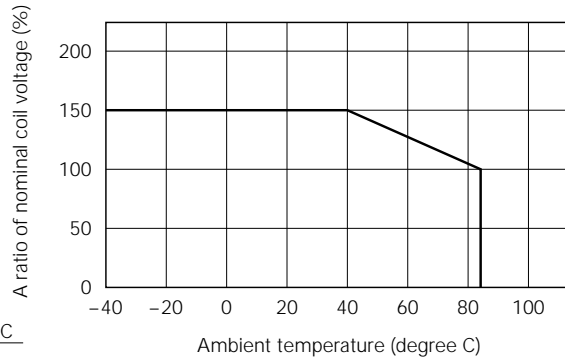

■ APPLIED VOLTAGE VS. TIMING (Sample: EC2-5NU)

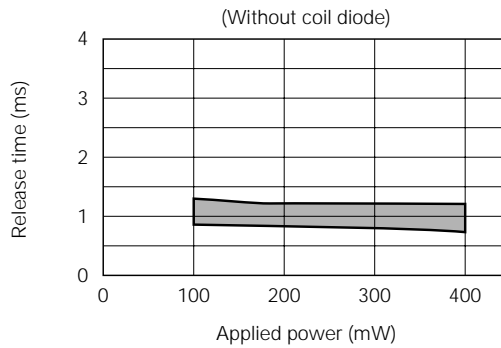
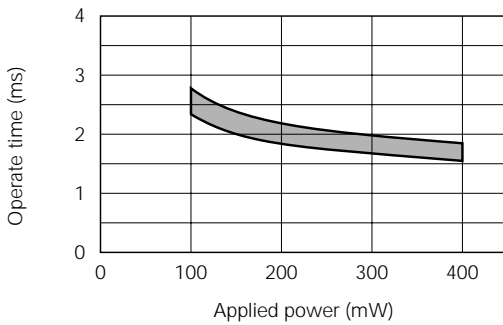

OPERATE AND RELEASE VOLTAGE VS. AMBIENT TEMPERATURE

This shows a typical change of operate (release) voltage. Maximum value of operate estimated, so it must be applied more than this value for safety operation. In case of "hot start operation", please inquiry for NEC.

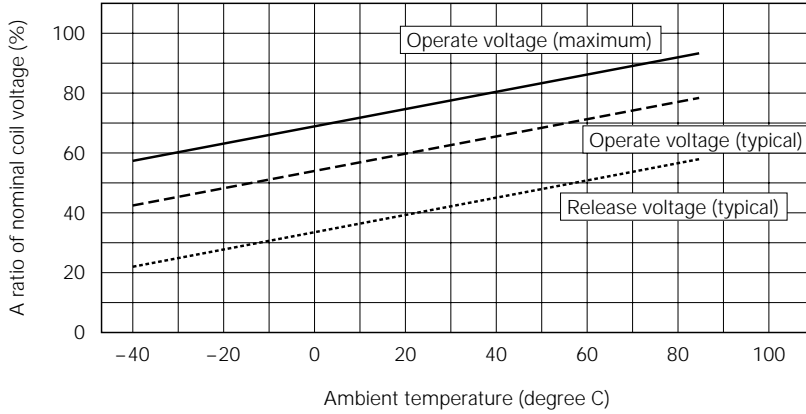

RUNNING TEST (Nonload)

(Load: None, Driving: 5V.DC, 50 Hz, 50% duty, Ambient temperature: Room temperature, Sample: EC2-5NU 20 pieces)

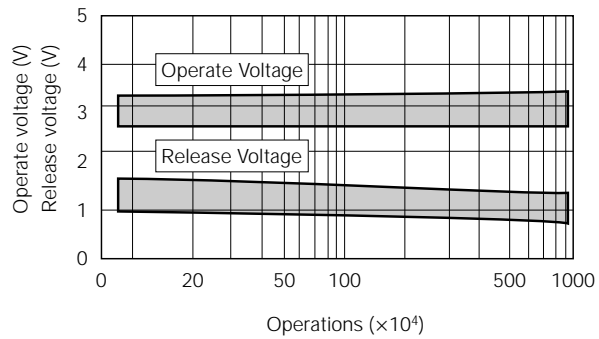
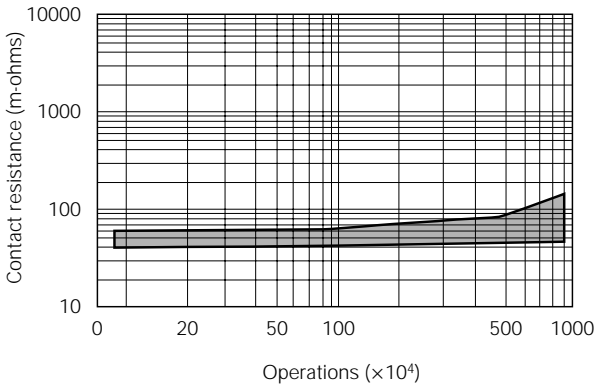

RUNNING TEST (Load)

(Load: 50 V.DC 0.1 A resistive, Driving: 5V.DC, 5 Hz, 50% duty, Ambient temperature: 85 degree C, Sample: EC2-5NU 10 pieces)

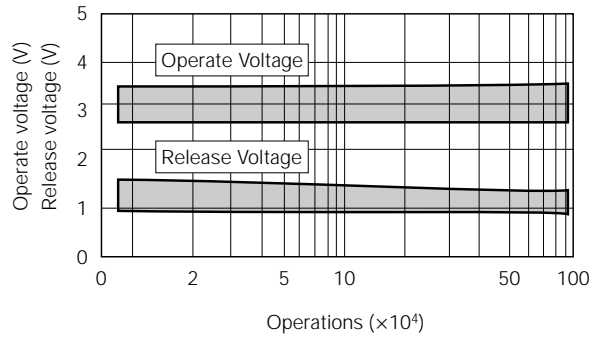
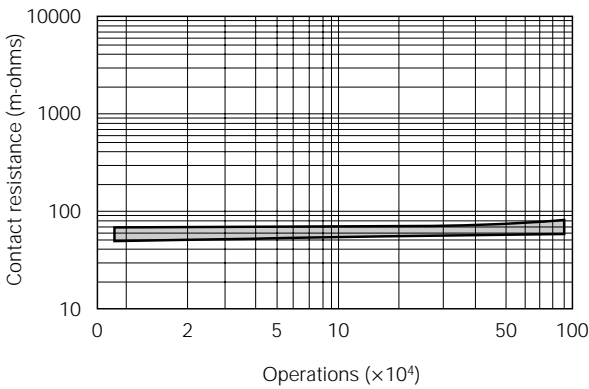

■ BREAKDOWN VOLTAGE
Sample: EC2-5NU 10 pieces

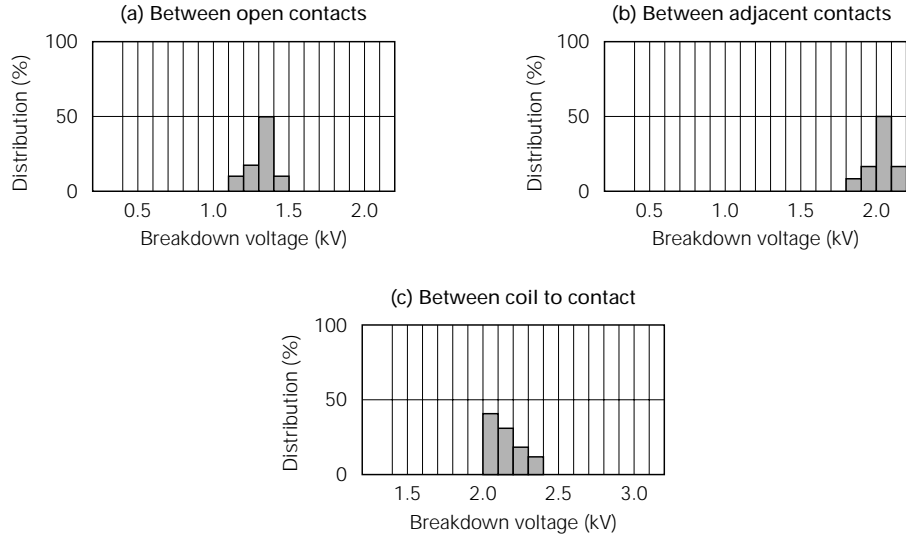

■ ALTERNATION OF VOLTAGE AT DENSELY MOUNTING (Magnet interference)

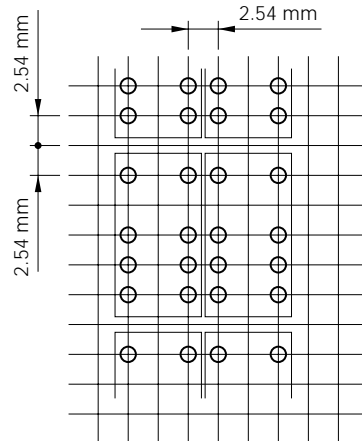
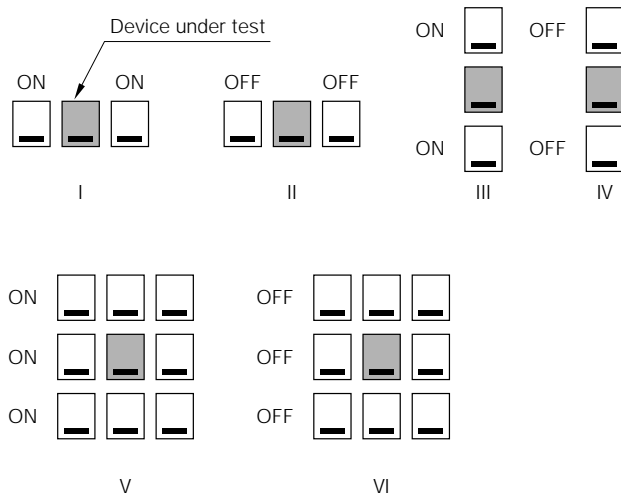
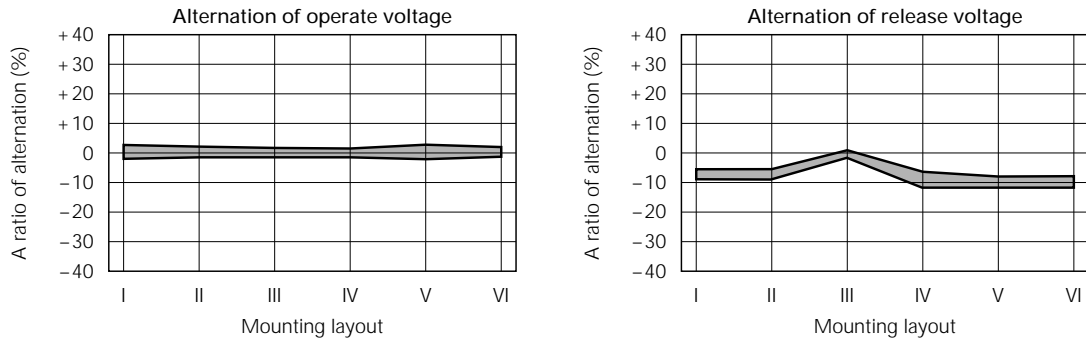

PACKAGE

Dimensions of Relay Tube (Unit : mm)

35 pieces / Tube
Material : Polyvinyl chloride
(anti-static treated)

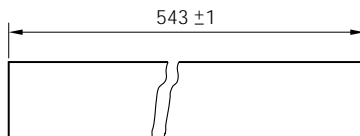
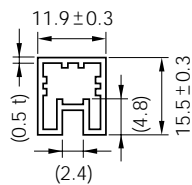

() Reference

Outline of Package

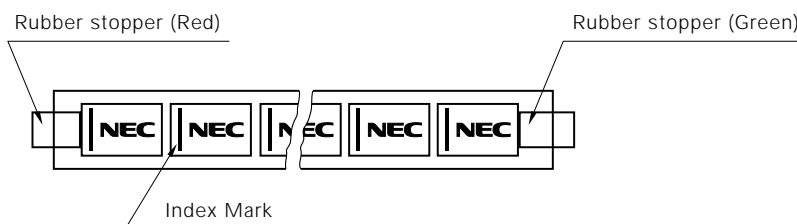

Notes on Correct Use

1. Notes on contact load

Make sure that the contact load is within the specified range; otherwise, the lifetime of the contacts will be shortened considerably. Note that the running performance shown is an example, and that it varies depending on parameters such as the type of load, switching frequency, driver circuit, and ambient temperature under the actual operating conditions. Evaluate the performance by using the actual circuit before using the relay.

2. Driving relays

- If the internal connection diagram of a relay shows + and - symbols on the coil, apply the rated voltage to the relay in the specified direction. If a rippled DC current source is used, abnormalities such as beat at the coil may occur.
- The maximum voltage that can be applied to the coil of the relay varies depending on the ambient temperature. Generally, the higher the voltage applied to the coil, the shorter the operating time. Note, however, that a high voltage also increases the bounce of the contacts and the contact opening and closing frequency, which may shorten the lifetime of the contacts.
- If the driving voltage waveform of the relay coil rises and falls gradually, the inherent performance of the relay may not be fully realized. Make sure that the voltage waveform instantaneously rises and falls as a pulse.

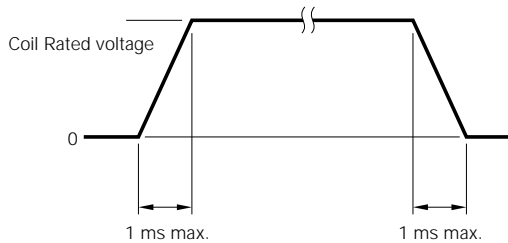

- For a latching relay, apply a voltage to the coil according to the polarity specified in the internal connection diagram of the relay.
- If a current is applied to the coil over a long period of time, the coil temperature rises, promoting generation of organic gas inside the relay, which may result in faulty contacts. In this case, use of a latching relay is recommended.
- The operating time and release time indicate the time required for each contact to close after the voltage has been applied to or removed from the coil. However, because the relay has a mechanical structure, a bounce state exists at the end of the operating and release times. Furthermore, because additional time is required until the contact stabilizes after being in a high-resistance state, care must be taken when using the relay at high speeds.

3. Operating environment

- Make sure that the relay mounted in the application set is used within the specified temperature range. Use of a relay at a temperature outside this range may adversely affect insulation or contact performance.
- If the relay is used for a long period of time in highly humid (RH 85% or higher) environment, moisture may be absorbed into the relay. This moisture may react with the NOx and SOx generated by glow discharges that occur when the contacts

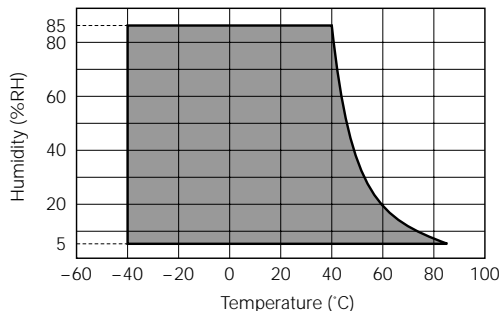

- are opened or closed, producing nitric or sulfuric acid. If this happens, the acid produced may corrode the metallic parts of the relay, causing operational malfunction.
- Because the operating temperature range varies depending on the humidity, use the relay in the temperature range illustrated in the figure below. Prevent the relay from being frozen and avoid the generation of condensation.
- The relay maintains constant sealability under normal atmospheric pressure (810 to 1,200 hpa). Its sealability may be degraded or the relay may be deformed and malfunction if it is used under barometric conditions exceeding the specified range.
- The same applies when the relay is stored or transported. Keep the upper-limit value of the temperature to which the relay is exposed after it is removed from the carton box to within 50°C.
- If excessive vibration or shock is applied to the relay, it may malfunction and the contacts remain closed. Vibration or shock applied to the relay during operation may cause considerable damage to or wearing of the contacts. Note that operation of a snap switch mounted close to the relay or shock due to the operation of magnetic solenoid may also cause malfunctioning.

4. Notes on mounting relays

- When mounting a relay onto a PC board using an automatic chip mouter, if excessive force is applied to the cover of the relay when the relay is chucked or inserted, the cover may be damaged or the characteristics of the relay degraded. Keep the force applied to the relay to within 1 kg.
- Avoid bending the pins to temporarily secure the relay to the PC board. Bending the pins may degrade sealability or adversely affect the internal mechanism.
- It is recommended to solder the relay onto a PC board under the following conditions:
 - <1> Reflow soldering
Refer to the recommended soldering temperature profile.
 - <2> Flow soldering
Solder temperature: 250°C max., Time: 5 to 10 seconds, Preheating: 100°C max./1 minute max.
 - <3> Manual soldering
Solder temperature: 350°C, Time: 2 to 3 seconds
- Ventilation immediately after soldering is recommended. Avoid immersing the relay in cleaning solvent immediately after soldering due to the danger of thermal shock being applied to the relay.
- Use an alcohol-based or water-based cleaning solvent. Never use thinner and benzene because they may damage the relay housing.
- Do not use ultrasonic cleaning because the vibration energy generated by the ultrasonic waves may cause the contacts to remain closed.

5. Handling

- Relays are packaged in magazine cases for shipment. If a space is created in the case after some relays have been removed, be sure to insert a stopper to secure the remaining relays in the case. If relays are not well secured, vibration during transportation may cause malfunctioning of the contacts.
- Exercise care in handling the relay so as to avoid dropping it or allowing it to fall. Do not use a relay that has been dropped. If a relay drops from a workbench to the floor, a shock of 9,800 m/s² (1,000 G) or more is applied to the relay, possibly damaging its functions. Even if a light shock has been applied to the relay, thoroughly evaluate its operation before using it.
- Latching relays are factory-set to the reset state for shipment. A latching relay may be set, however, by vibration or shock applied while being transported. Be sure to forcibly reset the relay before using it in the application set. Also note that the relay may be set by unexpected vibration or shock when it is used in a portable set.
- The sealability of a surface-mount relay may be lost if the relay absorbs moisture and is then heated during soldering. When storing relays, therefore, observe the following points:
 - <1> The storage humidity must be no more than 70% RH. The recommended storage period is 3 months maximum.
 - <2> To store the relay for 3 months or longer, keep the storage humidity to within 50% RH. Do not store the relay for more than 6 months.

No part of this document may be copied or reproduced in any form or by any means without the prior written consent of NEC Corporation. NEC Corporation assumes no responsibility for any errors which may appear in this document.

NEC Corporation does not assume any liability for infringement of patents, copyrights or other intellectual property rights of third parties by or arising from use of a device described herein or any other liability arising from use of such device. No license, either express, implied or otherwise, is granted under any patents, copyrights or other intellectual property rights of NEC Corporation or others.

While NEC Corporation has been making continuous effort to enhance the reliability of its electronic components, the possibility of defects cannot be eliminated entirely. To minimize risks of damage or injury to persons or property arising from a defect in an NEC electronic component, customers must incorporate sufficient safety measures in its design, such as redundancy, fire-containment, and anti-failure features. NEC devices are classified into the following three quality grades:

"Standard", "Special", and "Specific". The Specific quality grade applies only to devices developed based on a customer designated "quality assurance program" for a specific application. The recommended applications of a device depend on its quality grade, as indicated below. Customers must check the quality grade of each device before using it in a particular application.

Standard: Computers, office equipment, communications equipment, test and measurement equipment, audio and visual equipment, home electronic appliances, machine tools, personal electronic equipment and industrial robots

Special: Transportation equipment (automobiles, trains, ships, etc.), traffic control systems, anti-disaster systems, anti-crime systems, safety equipment and medical equipment (not specifically designed for life support)

Specific: Aircrafts, aerospace equipment, submersible repeaters, nuclear reactor control systems, life support systems or medical equipment for life support, etc.

The quality grade of NEC devices is "Standard" unless otherwise specified in NEC's Data Sheets or Data Books. If customers intend to use NEC devices for applications other than those specified for Standard quality grade, they should contact an NEC sales representative in advance.

(Note)

(1) "NEC" as used in this statement means NEC Corporation and also includes its majority-owned subsidiaries.

(2) "NEC electronic component products" means any electronic component product developed or manufactured by or for NEC (as defined above).

DE0202