

NAIS

HIGH SENSITIVITY RELAY WITH GUARANTEED LOW LEVEL SWITCHING CAPACITY

SX-RELAYS

FEATURES

1. High contact reliability over a long life has been made possible for low level loads.

Using a low level load (1 mV 10 μ A to 10 V 10 mA) 10⁷ operations were achieved with a static contact resistance of Max. 100 m Ω (voltage drop of 20 mV, 1 mA, 1 kHz) and a dynamic contact resistance of Max. 1 Ω (Measurement delay 10 ms, voltage drop of 20 mV, 1 mA, 1 kHz).

2. High sensitivity of 50 mW

By using the highly efficient polar magnetic circuit "seesaw balance armature mechanism", a rated power consumption of 50 mW (for single side stable type) has been achieved.

3. Low thermal electromotive force

Reducing the heat from the coil enables a thermal electromotive force of 3 μ V or less.

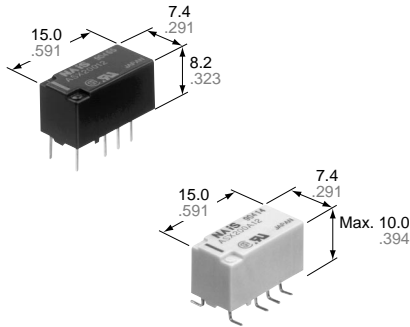

mm inch

SPECIFICATIONS

Contact		
Arrangement		2 Form C
Static contact resistance (During initial and electric life tests)* ¹ (By voltage drop of 20 mV 1 mA [1kHz])		Max. 100 m Ω
Dynamic contact resistance (During initial and electric life tests)* ¹ (By voltage drop of 20 mV 1 mA [1 kHz], Measurement delay 10 ms after applying nominal coil voltage)		Max. 1 Ω
Contact material		Gold-clad silver alloy
Rating	Nominal switching capacity (resistive load)	10 mA 10 VDC
	Max. switching power	0.1 W
	Max. switching voltage	10 VDC
	Max. switching current	10 mA DC
	Min. switching capacity** ¹	10 μ A 1 mVDC
Nominal operating power	Single side stable	50mW (1.5 to 12 V DC) 70mW (24 V DC)
	1 coil latching	35mW (1.5 to 12 V DC) 50mW (24 V DC)
	2 coil latching	70mW (1.5 to 12 V DC) 150mW (24 V DC)
Thermal electromotive force, max. (at nominal voltage applied to the coil** ²)		3 μ V
Expected life (min. operations)	Mechanical (at 750 cpm)	5 \times 10 ⁷
	Electrical (at 750 cpm) (10 mA 10 V DC resistive load)	10 ⁷

Characteristics		
Initial insulation resistance* ²		Min. 10,000M Ω (at 500V DC)
Initial breakdown voltage* ³	Between open contacts	750 Vrms for 1min.
	Between contact sets	1,000 Vrms for 1min.
	Between contact and coil	1,800 Vrms for 1min.
Operate time [Set time]* ⁴ (at 20°C)		Max. 5 ms (Approx. 3 ms) [Max. 5 ms (Approx. 3 ms)]
Release time (without diode) [Reset time]* ⁴ (at 20°C)		Max. 5 ms (Approx. 1.5 ms) [Max. 5 ms (Approx. 3 ms)]
Temperature rise* ⁵ (at 20°C)		Max. 50°C
Shock resistance	Functional* ⁶	Min. 750 m/s ² {75G}
	Destructive* ⁷	Min. 1,000 m/s ² {100G}
Vibration resistance	Functional* ⁸	10 to 55 Hz at double amplitude of 3.3 mm
	Destructive	10 to 55 Hz at double amplitude of 5 mm
Conditions for operation, transport and storage* ⁹ (Not freezing and condensing at low temperature)	Ambient temperature	-40°C to 70°C -40°F to 158°F
	Humidity	5 to 85% R.H.
Unit weight		Approx. 2 g .071 oz

Remarks:

* Specifications will vary with foreign standards certification ratings.

*¹ By nominal switching capacity: No. of operations: 10⁷

*² Measurement at same location as "Initial breakdown voltage" section.

*³ Detection current: 10mA.

*⁴ Nominal voltage applied to the coil, excluding contact bounce time.

*⁵ By resistive method, nominal voltage applied to the coil; contact carrying current: 10mA.

*⁶ Half-wave pulse of sine wave: 6 ms; detection time: 10 μ s.

*⁷ Half-wave pulse of sine wave: 6 ms.

*⁸ Detection time: 10 μ s.

*⁹ Refer to 5. Conditions for operation, transport and storage mentioned in AMBIENT ENVIRONMENT (Page 61)

Notes:

**¹ This value can change due to the switching frequency, environmental conditions, and desired reliability level, therefore it is recommended to check this with the actual load.

**² For single side stable only.

TYPICAL APPLICATIONS

This relay will be used for the small load for measuring instruments or others where a stable contact resistance is required.

ORDERING INFORMATION

Ex. ASX 2 0 0 A 1 H Z

Contact arrangement	Operating function	Type of operation	Terminal shape	Coil voltage (DC)	Packing style
2: 2 Form C	0: Single side stable 1: 1 coil latching 2: 2 coil latching	0: Standard type (B.B.M.)	Nil: Standard PC board terminal A: Surface-mount terminal	1H: 1.5V 09: 9V 03: 3V 12: 12V 4H: 4.5V 24: 24V 06: 6V	Nil: Tube packing Z: Tape and reel packing (piked from 8/9/10/12 pin side)

Note: Tape and reel packing symbol "-Z" is not marked on the relay. "X" type tape and reel packing (picked from 1/3/4/5-pin side) is also available. Suffix "X" instead of "Z".

TYPES AND COIL DATA (at 20°C 68°F)

(1) Standard PC board terminal

1) Standard packing: 40 pcs. in an inner package (tube); 1,000 pcs. in an outer package

2) Specified value of pick-up, drop-out, set and reset voltage is with the condition of square wave coil pulse.

Single side stable

Part No.	Coil Rating, V DC	Pick-up voltage, V DC (max.) (initial)	Drop-out voltage, V DC (min.) (initial)	Nominal operating current, mA (±10%)	Coil resistance, Ω (±10%)	Nominal operating power, mW	Max. allowable voltage, V DC
Standard PC board terminal							
ASX2001H	1.5	1.2	0.15	33.3	45	50	2.25
ASX20003	3	2.4	0.3	16.7	180	50	4.5
ASX2004H	4.5	3.6	0.45	11.1	405	50	6.75
ASX20006	6	4.8	0.6	8.3	720	50	9
ASX20009	9	7.2	0.9	5.6	1,620	50	13.5
ASX20012	12	9.6	1.2	4.2	2,880	50	18
ASX20024	24	19.2	2.4	2.9	8,229	70	36

1 coil latching

Part No.	Coil Rating, V DC	Set voltage, V DC (max.) (initial)	Reset voltage, V DC (max.) (initial)	Nominal operating current, mA (±10%)	Coil resistance, Ω (±10%)	Nominal operating power, mW	Max. allowable voltage, V DC
Standard PC board terminal							
ASX2101H	1.5	1.2	1.2	23.3	64.3	35	2.25
ASX21003	3	2.4	2.4	11.7	257	35	4.5
ASX2104H	4.5	3.6	3.6	7.8	579	35	6.75
ASX21006	6	4.8	4.8	5.8	1,029	35	9
ASX21009	9	7.2	7.2	3.9	2,314	35	13.5
ASX21012	12	9.6	9.6	2.9	4,114	35	18
ASX21024	24	19.2	19.2	2.1	11,520	50	36

2 coil latching

Part No.	Coil Rating, V DC	Set voltage, V DC (max.) (initial)	Reset voltage, V DC (max.) (initial)	Nominal operating current, mA (±10%)		Coil resistance, Ω (±10%)		Nominal operating power, mW		Max. allowable voltage, V DC
				Set coil	Reset coil	Set coil	Reset coil	Set coil	Reset coil	
Standard PC board terminal										
ASX2201H	1.5	1.2	1.2	46.7	46.7	32.1	32.1	70	70	2.25
ASX22003	3	2.4	2.4	23.3	23.3	129	129	70	70	4.5
ASX2204H	4.5	3.6	3.6	15.6	15.6	289	289	70	70	6.75
ASX22006	6	4.8	4.8	11.7	11.7	514	514	70	70	9
ASX22009	9	7.2	7.2	7.8	7.8	1,157	1,157	70	70	13.5
ASX22012	12	9.6	9.6	5.8	5.8	2,057	2,057	70	70	18
ASX22024	24	19.2	19.2	6.3	6.3	3,840	3,840	150	150	36

SX

(2) Surface-mount terminal

1) Standard packing: 40 pcs.(tube), 1,000pcs. (tape and reel)in an inner package; 500 pcs.(tube), 1,000pcs. (tape and reel)in an outer package

2) Specified value of pick-up, drop-out, set and reset voltage is with the condition of square wave coil pulse.

Single side stable

Part No.		Coil Rating, V DC	Pick-up voltage, V DC (max.) (initial)	Drop-out voltage, V DC (min.) (initial)	Nominal operating current, mA (±10%)	Coil resistance, Ω (±10%)	Nominal operating power, mW	Max. allowable voltage, V DC
Tube packing	Tape and reel packing							
ASX200A1H	ASX200A1HZ	1.5	1.2	0.15	33.3	45	50	2.25
ASX200A03	ASX200A03Z	3	2.4	0.3	16.7	180	50	4.5
ASX200A4H	ASX200A4HZ	4.5	3.6	0.45	11.1	405	50	6.75
ASX200A06	ASX200A06Z	6	4.8	0.6	8.3	720	50	9
ASX200A09	ASX200A09Z	9	7.2	0.9	5.6	1,620	50	13.5
ASX200A12	ASX200A12Z	12	9.6	1.2	4.2	2,880	50	18
ASX200A24	ASX200A24Z	24	19.2	2.4	2.9	8,229	70	36

1 coil latching type

Part No.		Coil Rating, V DC	Set voltage, V DC (max.) (initial)	Reset voltage, V DC (max.) (initial)	Nominal operating current, mA (±10%)	Coil resistance, Ω (±10%)	Nominal operating power, mW	Max. allowable voltage, V DC
Tube packing	Tape and reel packing							
ASX210A1H	ASX210A1HZ	1.5	1.2	1.2	23.3	64.3	35	2.25
ASX210A03	ASX210A03Z	3	2.4	2.4	11.7	257	35	4.5
ASX210A4H	ASX210A4HZ	4.5	3.6	3.6	7.8	579	35	6.75
ASX210A06	ASX210A06Z	6	4.8	4.8	5.8	1,029	35	9
ASX210A09	ASX210A09Z	9	7.2	7.2	3.9	2,314	35	13.5
ASX210A12	ASX210A12Z	12	9.6	9.6	2.9	4,114	35	18
ASX210A24	ASX210A24Z	24	19.2	19.2	2.1	11,520	50	36

2 coil latching type

Part No.		Coil Rating, V DC	Set voltage, V DC (max.) (initial)	Reset voltage, V DC (max.) (initial)	Nominal operating current, mA (±10%)		Coil resistance, Ω (±10%)		Nominal operating power, mW		Max. allowable voltage, V DC
Tube packing	Tape and reel packing				Set coil	Reset coil	Set coil	Reset coil	Set coil	Reset coil	
ASX220A1H	ASX220A1HZ	1.5	1.2	1.2	46.7	46.7	32.1	32.1	70	70	2.25
ASX220A03	ASX220A03Z	3	2.4	2.4	23.3	23.3	129	129	70	70	4.5
ASX220A4H	ASX220A4HZ	4.5	3.6	3.6	15.6	15.6	289	289	70	70	6.75
ASX220A06	ASX220A06Z	6	4.8	4.8	11.7	11.7	514	514	70	70	9
ASX220A09	ASX220A09Z	9	7.2	7.2	7.8	7.8	1,157	1,157	70	70	13.5
ASX220A12	ASX220A12Z	12	9.6	9.6	5.8	5.8	2,057	2,057	70	70	18
ASX220A24	ASX220A24Z	24	19.2	19.2	6.3	6.3	3,840	3,840	150	150	36

DIMENSIONS

mm inch

1. PC board terminal



Single side stable/
1 coil latching

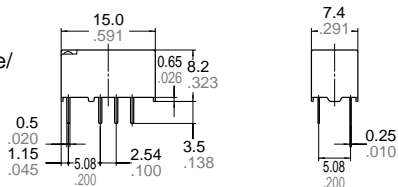

PC board pattern

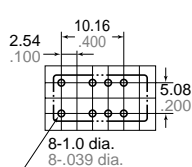

Schematic (Bottom view)

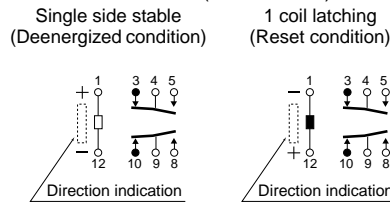

2 coil latching

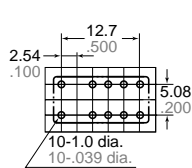
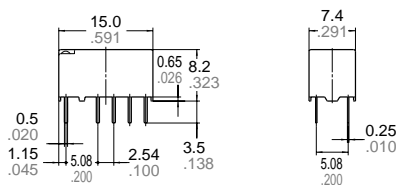

2 coil latching
(Reset condition)

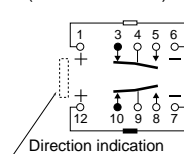

General tolerance: $\pm 0.3 \pm 0.12$

Tolerance: $\pm 0.1 \pm 0.04$

2. Surface-mount terminal

mm inch

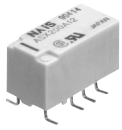

Single side stable/
1 coil latching

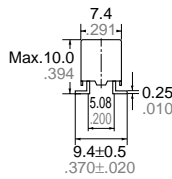
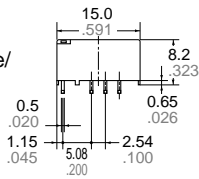

Suggested
mounting pad

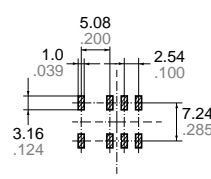

Schematic (Top view)

Single side stable
(Deenergized condition)

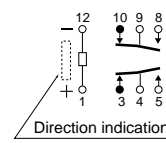

1 coil latching
(Reset condition)

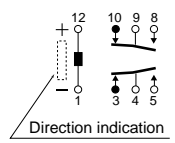

2 coil latching

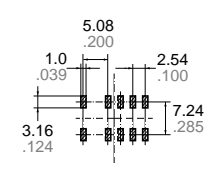
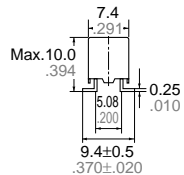
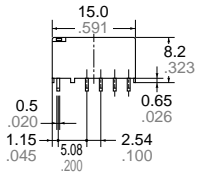

2 coil latching
(Reset condition)

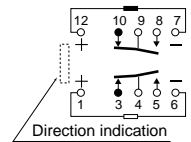

General tolerance: $\pm 0.3 \pm .012$

Tolerance: $\pm 0.1 \pm .004$

REFERENCE DATA

1. Switching capacity range

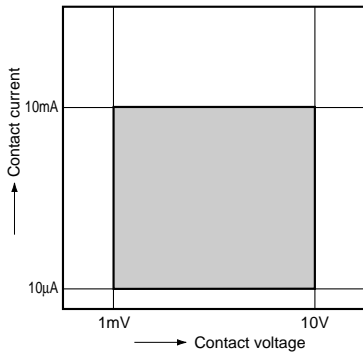

2-(1). Change in dynamic contact resistance
(10 mA 10 V DC resistive load)

Tested: ASX20012, Quantity: n=10
Operating frequency: 750 cpm
Measured condition: 10 ms after applying nominal coil voltage, using voltage drop of 20 mV, 1 mA, 1 kHz.

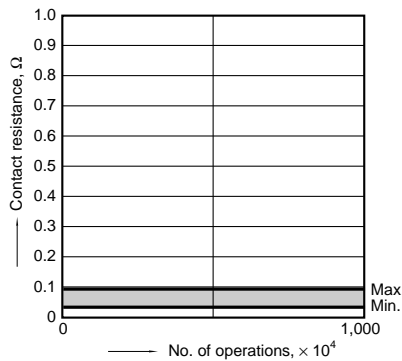

2-(2). Change in dynamic contact resistance
(10 µA 1 mV DC resistive load)

Tested: ASX20012, Quantity: n=10
Operating frequency: 750 cpm
Measured condition: 10 ms after applying nominal coil voltage, using voltage drop of 20 mV, 1 mA, 1 kHz.

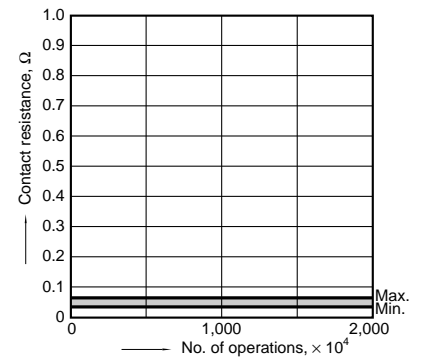

3-(1). Change in static contact resistance
(10 mA 10 V DC resistive load)

Tested: ASX20012, Quantity: n=10
Operating frequency: 750 cpm

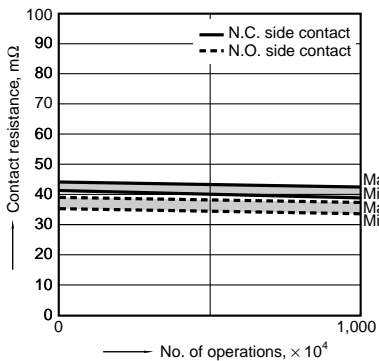

3-(2). Change in static contact resistance
(10 µA 1 mVDC resistive load)

Tested: ASX20012, Quantity: n=10
Operating frequency: 750 cpm

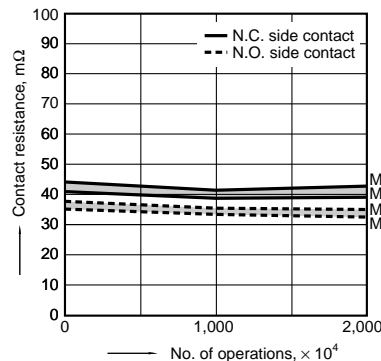

SX

NOTES

1. Coil operating power

- 1) As a general rule, only a pure DC power supply should be used for the coil drive.
- 2) To ensure proper operation, the voltage applied to both terminals of the coil should be $\pm 5\%$ (at 20°C 68°F) the rated operating voltage of the coil. Also, be aware that the pick-up and drop-out voltages will fluctuate depending on the ambient temperature and operating conditions.
- 3) The ripple factor for the voltage applied to the coil should be less than 5%.
- 4) For set and reset latching relays, the rated operating voltage should be applied to the coil for 10 ms or more.

2. Coil connection

When connecting coils, refer to the wiring diagram to prevent mis-operation or malfunction.

3. External magnetic field

Since SX relays are highly sensitive polarized relays, their characteristics will be affected by a strong external magnetic field. Avoid using the relay under that condition.

4. Cleaning

In automatic cleaning, cleaning with the boiling method is recommended. Avoid ultrasonic cleaning which subject the relay to high frequency vibrations. It may cause the contacts to stick. It is recommended that a fluorinated hydrocarbon or other alcoholic solvent be used.

5. Packing style

- 1) The relay is packed in a tube with the relay orientation mark on the left side, as shown in the figure below.

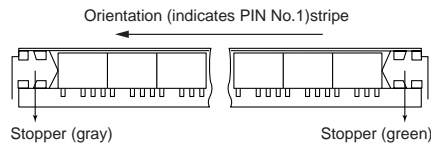

2) Tape and reel packing

(1) Tape dimensions

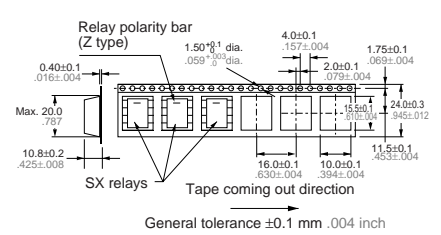

(2) Dimensions of plastic reel

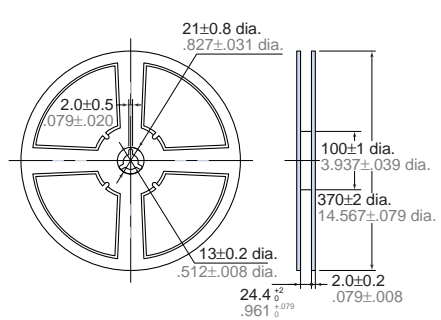

6. Automatic insertion

To maintain the internal function of the relay, the chucking pressure should not exceed the values below.

- Chucking pressure in the direction A: 4.9 N {500 gf} or less
- Chucking pressure in the direction B: 9.8 N {1 kgf} or less
- Chucking pressure in the direction C: 9.8 N {1 kgf} or less

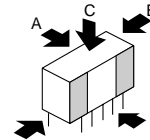

Please chuck the  portion. Avoid chucking the center of the relay. In addition, excessive chucking pressure to the pinpoint of the relay should be also avoided.

For Cautions for Use, see Relay Technical Information (Page 48 to 76).