

General Purpose Relay

G7L

- A high-capacity, high-withstand voltage relay compatible with momentary voltage drops
- No contact chattering for momentary voltage drops up to 50% of rated voltage
- UL Class B construction standard
- Wide-range AC-activated coil that handles 100 to 120 VAC at either 50 or 60 Hz
- Miniature hinge for maximum switching capacity, particularly for inductive loads
- Flame resistant materials (UL94V-0-qualifying) used for all insulation material
- Quick-connect, screw, and PCB terminals available
- Standard models are UL, CSA, and TUV approved; VDE versions now available
- Conforming to IEC 950



Ordering Information

To Order: Select the part number and add the desired coil voltage rating (e.g., G7L-1A-T-CB-AC100/120).

Replaces G5D series.

Type	Contact form	Part number		
		Quick-connect terminal	Screw terminal	PCB terminal
E bracket	SPST-NO	G7L-1A-T-CB (see note 1)	G7L-1A-B-CB (see note 1)	—
	DPST-NO	G7L-2A-T-CB (see note 1)	G7L-2A-B-CB (see note 1)	—
E bracket (with test button)	SPST-NO	G7L-1A-TJ-CB (see note 1)	G7L-1A-BJ-CB (see note 1)	—
	DPST-NO	G7L-2A-TJ-CB (see note 1)	G7L-2A-BJ-CB (see note 1)	—
Upper bracket	SPST-NO	G7L-1A-TUB-CB	G7L-1A-BUB-CB	—
	DPST-NO	G7L-2A-TUB-CB	G7L-2A-BUB-CB	—
Upper bracket (with test button)	SPST-NO	G7L-1A-TUBJ-CB	G7L-1A-BUBJ-CB	—
	DPST-NO	G7L-2A-TUBJ-CB	G7L-2A-BUBJ-CB	—
PCB mounting	SPST-NO	—	—	G7L-1A-P-CB
	DPST-NO	—	—	G7L-2A-P-CB

- Note: 1. E bracket or socket must be used for mounting (part number R99-07G5D). Refer to "Accessories" section for options and part numbers.
 2. For VDE approved versions, please consult OMRON.

MODEL NUMBER LEGEND

G7L- □ □ - □ □ □ □
 1 2 3 4 5 6

- | | | |
|---|---|---|
| <p>1. Contact form
 1A: SPST-NO
 2A: DPST-NO</p> <p>2. Terminal shape
 T: Quick-connect terminals
 P: PCB terminals
 B: Screw terminals</p> | <p>3. Mounting construction
 No symbol: E bracket type
 UB: Upper bracket type</p> <p>4. Special functions
 No symbol: Without test button
 J: With test button</p> | <p>5. 80: VDE approved version
 (includes UL, CSA and TÜV)</p> <p>6. CB: Class B insulation</p> <p>7. Rated coil voltage</p> |
|---|---|---|

ACCESSORIES

Quick-connect terminals

Description	Model				Part number
	Contact form				
	SPST-NO		DPST-NO		
E-brackets	G7L-1A-T	G7L-1A-TJ	G7L-2A-T	G7L-2A-TJ	R99-07G5D
Track mounting adaptor					P7LF-D
Front connecting socket					P7LF-06 (see note)
Cover					P7LF-C

Screw terminals

Description	Model				Part number
	Contact form				
	SPST-NO		DPST-NO		
E-brackets	G7L-1A-B	G7L-1A-BJ	G7L-2A-B	G7L-2A-BJ	R99-07G5D
Track mounting adaptor					P7LF-D

Note: P7LF-C cover is supplied with the P7LF-06 socket.

Specifications

CONTACT DATA

Load	G7L-1A-T, G7L-1A-B		G7L-2A-T, G7L-2A-B		G7L-1A-P, G7L-2A-P	
	Resistive load (cosφ = 1)	Inductive load (cosφ = 0.4)	Resistive load (cosφ = 1)	Inductive load (cosφ = 0.4)	Resistive load (cosφ = 1)	Inductive load (cosφ = 0.4)
Rated load	30 A, 220 VAC	25 A, 220 VAC			20 A, 220 VAC	
Contact material	AgCdO					
Carry current	30 A		25 A		20 A	
Max. operating voltage	250 VAC					
Max. operating current	30 A		25 A		20 A	
Max. switching capacity	6,600 VA	5,500 VA			4,400 VA	
Min. permissible load	100 mA, 5 VDC					

Note: P level: $\lambda_{60} = 0.1 \times 10^{-6}$ operation.

COIL INTERNAL CIRCUIT

DC operating coil

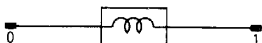

AC operating coil

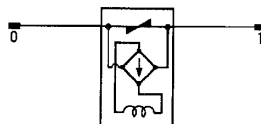



■ COIL DATA

AC

Rated voltage (V)	Rated current (mA)	Resistance (Ω)	Must operate	Must release	Max. voltage	Power consumption
			% of rated voltage			
6	283	18.90	75% max.	15% min.	110% max.	Approx. 1.70 to 2.50 VA
12	142	75				
24	71	303				
50	34	1,310				
100/120	17.00/20.40	5,260	75 volts	18 volts	132 volts	
200/240	8.50/10.20	21,000	150 volts	36 volts	264 volts	

DC

Rated voltage (V)	Rated current (mA)	Resistance (Ω)	Must operate	Must release	Max. voltage	Power consumption
			% of rated voltage			
6	317	18.90	75% max.	15% min.	110% max.	Approx. 1.90 W
12	158	75				
24	79	303				
48	40	1,220				
100	19	5,260				

Note: 1. The rated current and coil resistance are measured at a coil temperature of 23°C (73°F) with tolerances of +15%/-20% for AC rated current and ±15% for DC coil resistance.
 2. Performance characteristic data are measured at a coil temperature of 23°C (73°F).

■ CHARACTERISTICS

Contact resistance		50 mΩ max.
Operate time		30 ms max.
Release time		30 ms max.
Max. operating frequency	Mechanical	1,800 operations/hour
	Electrical	1,800 operations/hour (under rated load)
Insulation resistance		1,000 MΩ min. (at 500 VDC)
Dielectric strength		4,000 VAC, min./5,000 VAC typical, 50/60 Hz for 1 minute between coil and contacts
		2,000 VAC, 50/60 Hz for 1 minute between contacts of same pole
		2,000 VAC, 50/60 Hz for 1 minute between contacts of different poles (DPST-NO type)
Impulse withstand voltage		Between coil and contact: 10,000 V (impulse wave used: 1.20 x 50 μs)
Vibration	Mechanical durability	10 to 55 Hz; 1.50 mm (0.06 in) double amplitude
	Malfunction durability	10 to 55 Hz; 1.50 mm (0.06 in) double amplitude
Shock	Mechanical durability	1,000 m/s ² (approx. 100 G)
	Malfunction durability	1,000 m/s ² (approx. 10 G)
Life expectancy	Mechanical	5,000,000 operations min. (at 1,800 operations/hour)
	Electrical	100,000 operations min. (at 1,800 operations/hour under rated load)
Ambient temperature		-20° to 85°C (-4° to 185°F)
Humidity		35% to 85% RH
Weight	Quick-connect terminal type: approx. 90 g (3.17 oz)	
	PCB terminal type: approx. 100 g (3.52 oz)	
	Screw terminal type: approx. 120 g (4.23 oz)	

Note: Data shown are of initial value.

■ CHARACTERISTIC DATA

Maximum switching capacity

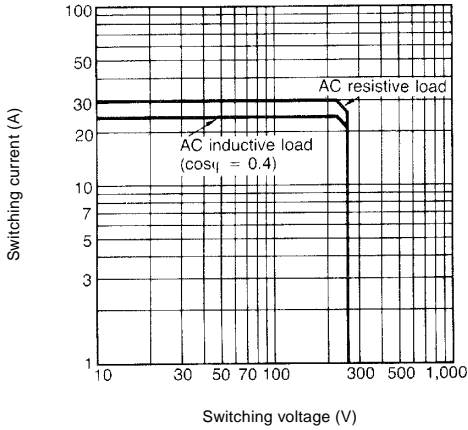

Electrical service life

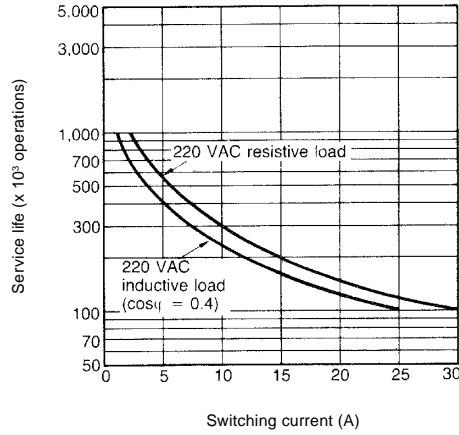

Dimensions

Unit: mm (inch)

■ RELAYS

G7L-1A-T
(E Bracket Attached)*

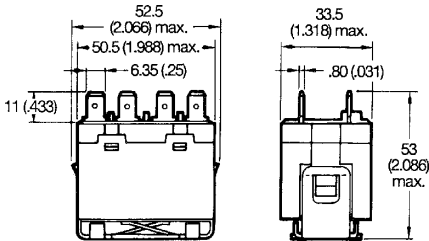

Terminal arrangement/
Internal connections
(Top view)

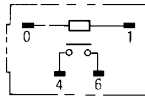

Mounting holes
(Bottom view)

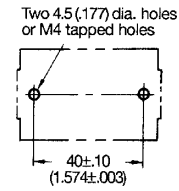

G7L-2A-T
(E Bracket Attached)*

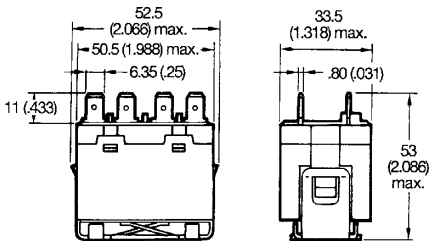

Terminal arrangement/
Internal connections
(Top view)

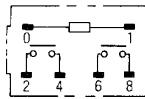

Mounting holes
(Bottom view)

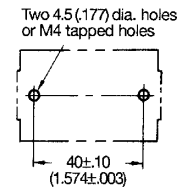

* E bracket must be ordered separately.



**G7L-1A-TJ
(E Bracket Attached)***

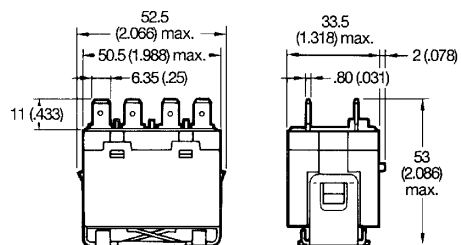

**Terminal arrangement/
Internal connections
(Top view)**

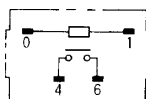

**Mounting holes
(Bottom view)**

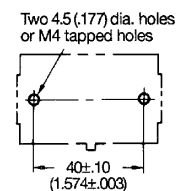

**G7L-2A-TJ
(E Bracket Attached)***

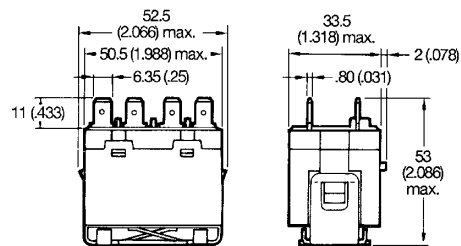

**Terminal arrangement/
Internal connections
(Top view)**

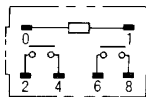

**Mounting holes
(Bottom view)**

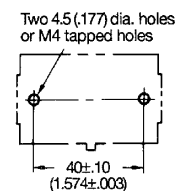

G7L-1A-TUB

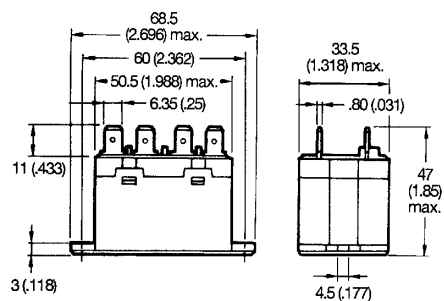

**Terminal arrangement/
Internal connections
(Top view)**

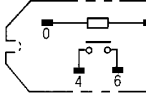

**Mounting holes
(Bottom view)**

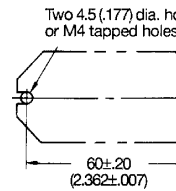

G7L-2A-TUB

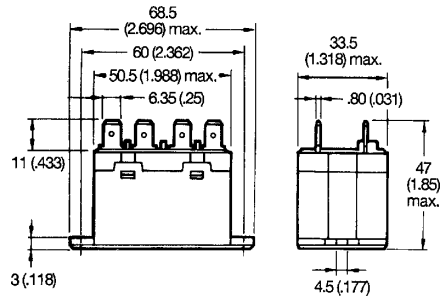

**Terminal arrangement/
Internal connections
(Top view)**

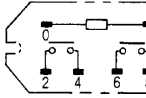

**Mounting holes
(Bottom view)**

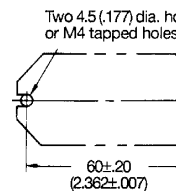

* E bracket must be ordered separately.

Unit: mm (inch)

■ RELAYS (continued)

G7L-1A-TUBJ

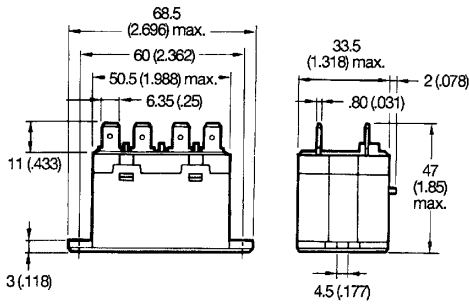

Terminal arrangement/
Internal connections
(Top view)

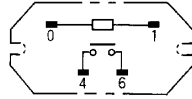

Mounting holes
(Bottom view)

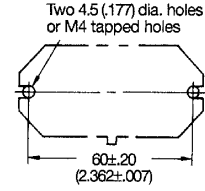

G7L-2A-TUBJ

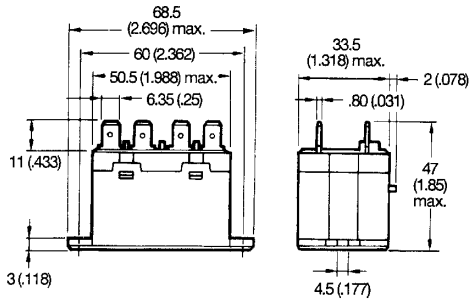

Terminal arrangement/
Internal connections
(Top view)

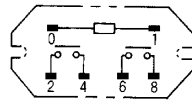

Mounting holes
(Bottom view)

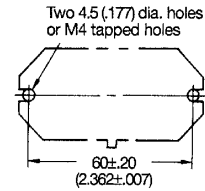

G7L-1A-B
(E bracket Attached)*

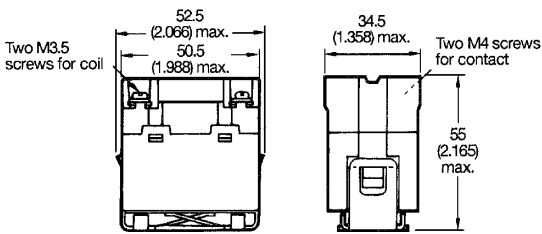

Terminal arrangement/
Internal connections
(Top view)

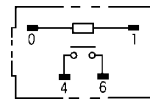

Mounting holes
(Bottom view)

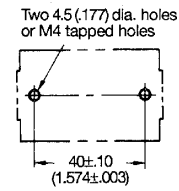

G7L-2A-B
(E bracket Attached)*

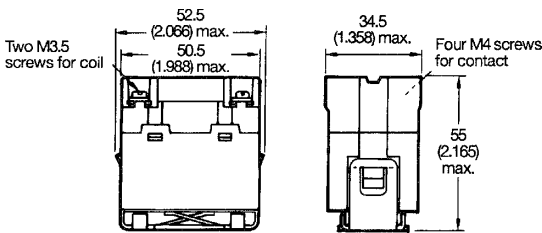

Terminal arrangement/
Internal connections
(Top view)

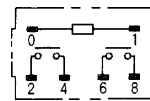

Mounting holes
(Bottom view)

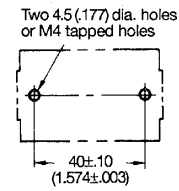

* E bracket must be ordered separately.

G7L-1A-BJ
(E bracket Attached)*

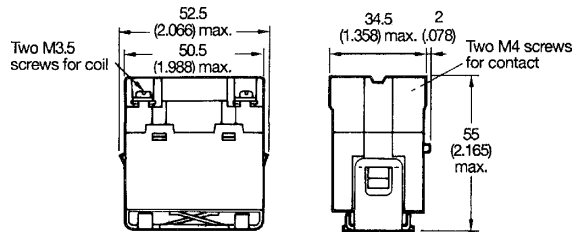

**Terminal arrangement/
Internal connections**
(Top view)

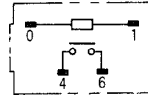

Mounting holes
(Bottom view)

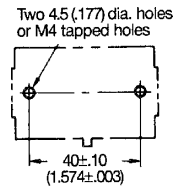

G7L-2A-BJ
(E bracket Attached)*

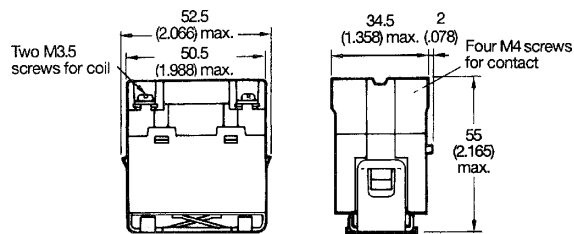

**Terminal arrangement/
Internal connections**
(Top view)

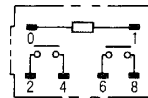

Mounting holes
(Bottom view)

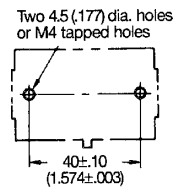

G7L-1A-BUB

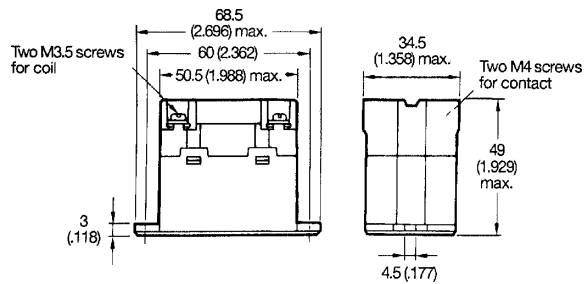

**Terminal arrangement/
Internal connections**
(Top view)

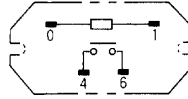

Mounting holes
(Bottom view)

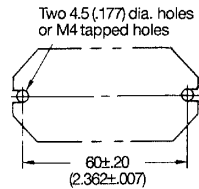

G7L-2A-BUB

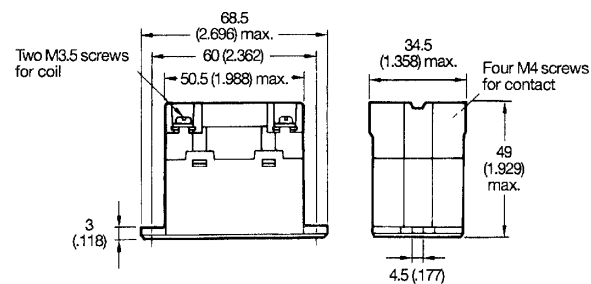

**Terminal arrangement/
Internal connections**
(Top view)

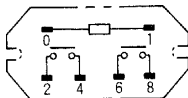

Mounting holes
(Bottom view)

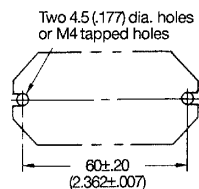

* E bracket must be ordered separately.

Unit: mm (inch)

■ RELAYS (continued)

G7L-1A-BUBJ

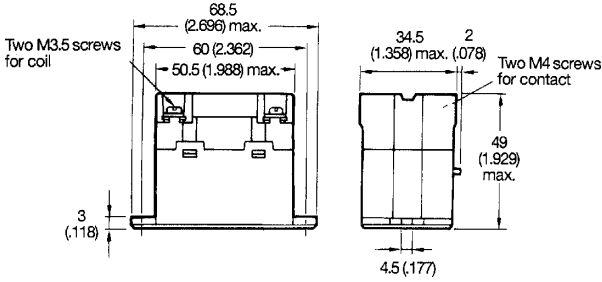

Terminal arrangement/
Internal connections
(Top view)

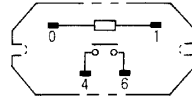

Mounting holes
(Bottom view)

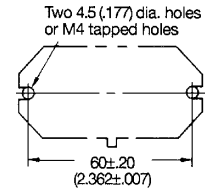

G7L-2A-BUBJ

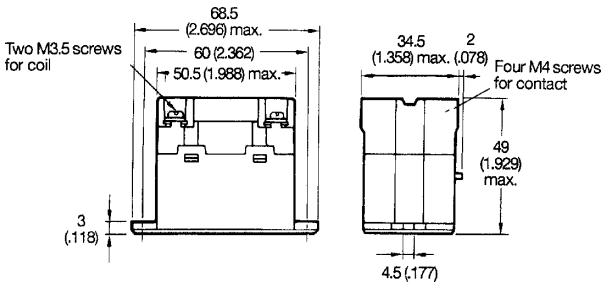

Terminal arrangement/
Internal connections
(Top view)

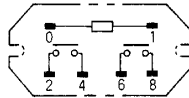

Mounting holes
(Bottom view)

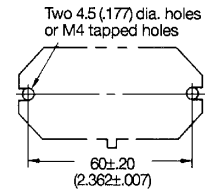

G7L-1A-P

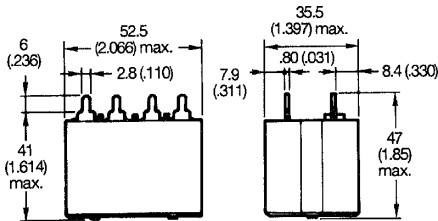

Terminal arrangement/
Internal connections
(Top view)

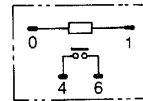

Mounting holes
(Bottom view)

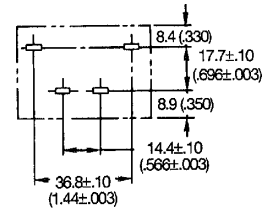

G7L-2A-P

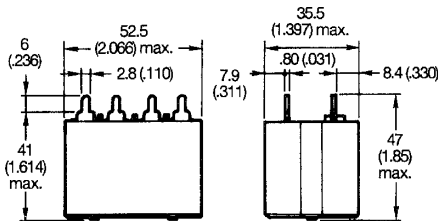

Terminal arrangement/
Internal connections
(Top view)

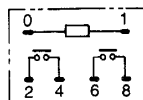

Mounting holes
(Bottom view)

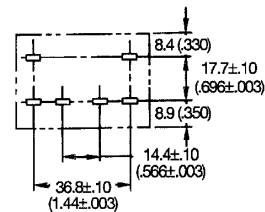

■ ACCESSORIES

E bracket R99-07G5D

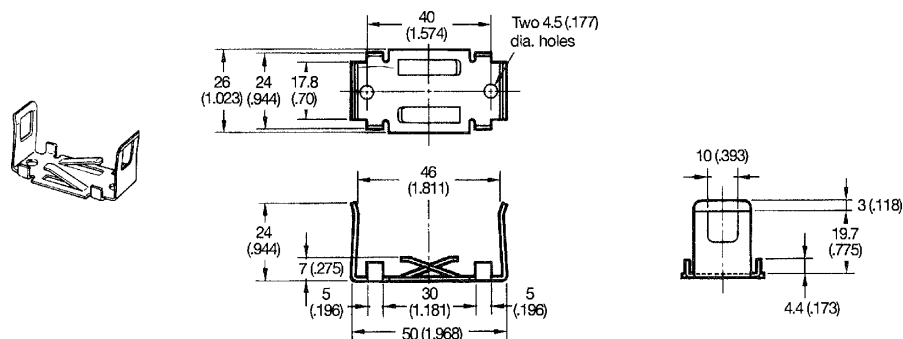

Mounting holes (Bottom view)

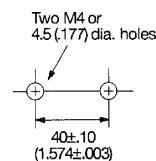

Adaptor P7LF-D

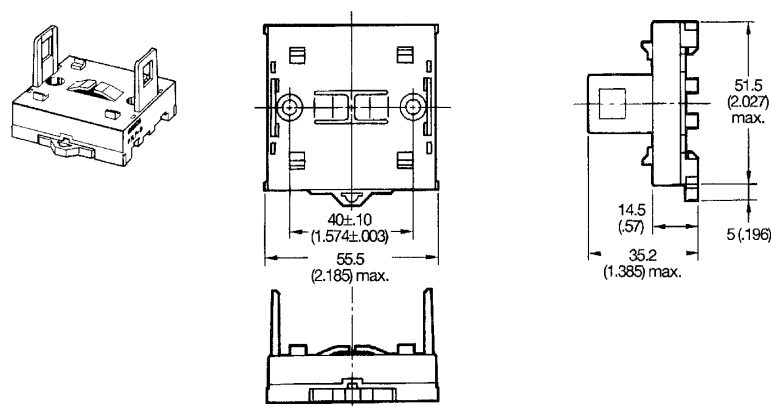

Mounting holes (Bottom view)

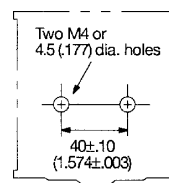

Front connecting socket P7LF-06

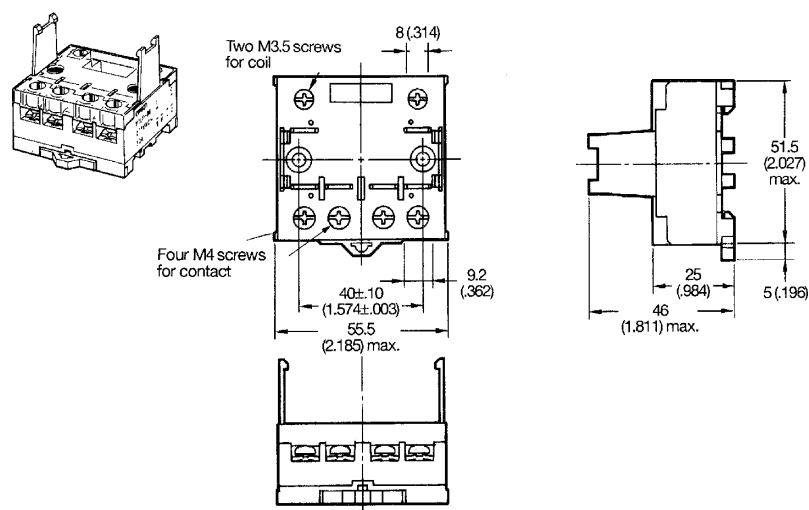

Mounting holes (Bottom view)

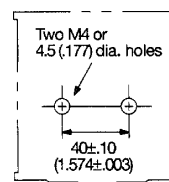

- Note: 1. To protect against electric shock, use the P7LF-C cover on terminals.
2. P7LF-C cover is supplied with P7LF-06 socket

Unit: mm (inch)

■ ACCESSORIES (continued)

Cover
P7LF-C

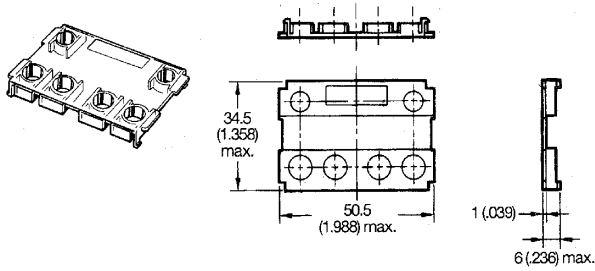

Note: P7LF-C cover is supplied with P7LF-06 socket

Mounting track

PFP-100N, PFP-50N

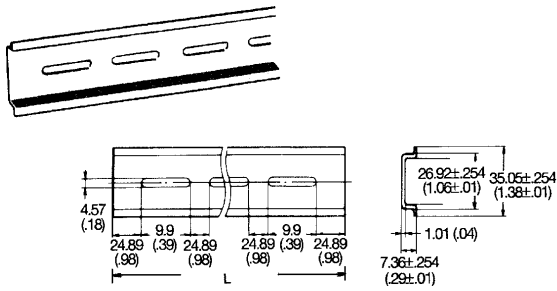

PFP-100N2

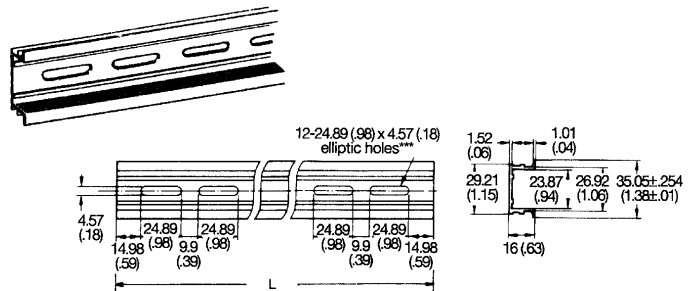

- Note: 1. It is recommended that a panel thickness of 1.60 to 2.00 mm (0.06 to 0.08 in) be used.
 2. L = Length
 PFP-100N L = 1 m (39.00 in)
 PFP-50N L = 50 cm (19.60 in)
 PFP-100N2 L = 1 m (39.00 in)

End plate

PFP-M

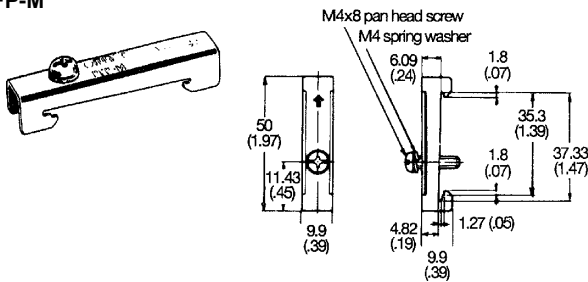

Spacer

PFP-S

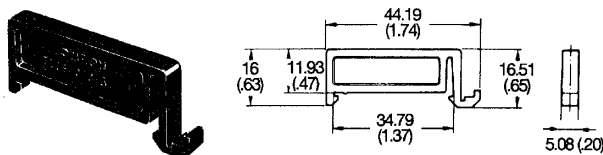

■ APPROVALS

UL recognized type (File No. E41643)/ CSA certified type (File No. LR35535)

Type	Contact form	Terminal type	Contact ratings
G7L-1A-T-CB	SPST-NO	Quick-connect	30 A, 277 VAC (Resistive) 30,000 c
G7L-1A-TJ-CB			30 A, 120 VAC (General purpose) 30,000 c
G7L-1A-TUB-CB			30 A, 277 VAC (General purpose) 30,000 c
G7L-1A-TUBJ-CB			1.5 kW, 120 VAC (Tungsten)
G7L-1A-B-CB		Screw	1.5 HP, 120 VAC
G7L-1A-BJ-CB			3 HP, 240/265/277 VAC
G7L-1A-BUB-CB			20 FLA/120 LRA, 120 VAC, 30,000 c
G7L-1A-BUBJ-CB			17 FLA/102 LRA, 277 VAC, 30,000 c
G7L-1A-P-CB	PCB	TV-10, 120 VAC	
		20 A (2.4 kW), 120 VAC (Tungsten)	
G7L-2A-T-CB	DPST-NO	Quick-connect	30 A, 277 VAC (Resistive) 30,000 c
G7L-2A-TJ-CB			30 A, 120 VAC (General purpose) 30,000 c
G7L-2A-TUB-CB			30 A, 277 VAC (General purpose) 30,000 c
G7L-2A-TUBJ-CB			1.5 kW, 120 VAC (Tungsten)
G7L-2A-B-CB		Screw	1.5 HP, 120 VAC
G7L-2A-BJ-CB			3 HP, 240/265/277 VAC
G7L-2A-BUB-CB			20 FLA/120 LRA, 120 VAC, 30,000 c
G7L-2A-BUBJ-CB			17 FLA/102 LRA, 277 VAC, 30,000 c
G7L-2A-P-CB	PCB	TV-10, 120 VAC	
		20 A (2.4 kW), 120 VAC (Tungsten)	

TÜV (File No. R9251551)

Type	Contact form	Coil ratings	Terminal type	Contact ratings
G7L-1A-T-CB	SPST-NO	6, 12, 24, 48, 100, 110, 200, 220 VDC	Quick-connect	25 A, 240 VAC, (cosφ = 1)
G7L-1A-TJ-CB				25 A, 240 VAC, (cosφ = 0.4)
G7L-1A-TUB-CB			Screw	30 A, 240 VAC, (cosφ = 1)
G7L-1A-TUBJ-CB				25 A, 240 VAC, (cosφ = 0.4)
G7L-1A-B-CB				30 A, 240 VAC, (cosφ = 0.4)
G7L-1A-BJ-CB				20 A, 240 VAC, (cosφ = 1)
G7L-1A-BUB-CB			PCB	20 A, 240 VAC, (cosφ = 0.4)
G7L-1A-BUBJ-CB				
G7L-1A-P-CB				
G7L-2A-T-CB	DPST-NO	12, 24, 50, 100/120, 200/240 VAC	Quick-connect	25 A, 240 VAC, (cosφ = 1)
G7L-2A-TJ-CB				25 A, 240 VAC, (cosφ = 0.4)
G7L-2A-TUB-CB			Screw	25 A, 240 VAC, (cosφ = 1)
G7L-2A-TUBJ-CB				25 A, 240 VAC, (cosφ = 0.4)
G7L-2A-B-CB				
G7L-2A-BJ-CB				
G7L-2A-BUB-CB			PCB	20 A, 240 VAC, (cosφ = 1)
G7L-2A-BUBJ-CB				20 A, 240 VAC, (cosφ = 0.4)
G7L-2A-P-CB				

VDE recognized type (Licence no. 1530 UG)

Note: 1. Please consult OMRON for details of VDE approvals.

2. The G7L relay conforms to the following standards: Electrical safety: DIN IEC 255 Teil 1-00/DIN VDE 0435 Teil 201/05. 83
DIN VDE 0435 Teil 201 A1/05. 90
DIN IEC 255 Teil 0-20/DIN VDE 0435 Teil 120/10. 81
DIN EN 60 950/VDE 0805/11. 93

EMC: prEN 50082-2, EN 55022

3. The rated values approved by each of the safety standards (e.g., UL and CSA) may be different from the performance characteristics individually defined in this catalog.

4. In the interest of product improvement, specifications are subject to change.

Precautions

■ HANDLING

- To preserve initial performance, do not drop or otherwise subject the power relay to shock.
- The case is not designed to be removed during normal handling and operation. Doing so may affect performance.
- Use the power relay in a dry environment free from excessive dust, SO₂, H₂S, or organic gas.
- Do not allow a voltage greater than the maximum allowable coil voltage to be applied continuously.
- Do not use the power relay outside of specified voltages and currents.
- Do not allow the ambient operating temperature to exceed the specified limit.

■ INSTALLATION

- Although there are not specific limits on the installation site, it should be as dry and dust-free as possible.
- PCB terminal-equipped relays weigh approximately 100 g. Be sure that the PCB is strong enough to support them. We recommend dual-side through-hole PCBs to reduce solder cracking from heat stress.
- Quick-connect terminals can be connected to fast on receptacle #250 and positive-lock connectors.
- Allow suitable slack on leads when wiring, and do not subject the terminals to excessive force.

■ CLEANING PCB TERMINALS

- PCB terminals have semi-sealed construction which prevents flux from entering the relay base. It is recommended that the user should apply a tape seal over the vent hole prior to wave soldering or cleaning. The tape should then be removed after processing.

■ APPLICATIONS

- Compressors for package air conditioners and heater switching controllers
- Switching controllers for power tools or motors
- Power controllers for water heaters
- Power controllers for dryers

■ OPERATING COIL

- As a rule, either a battery or a DC power supply with a maximum 5% ripple is used for the operating voltage for DC relays. Before using a rectified AC supply, confirm that the ripple is not greater than 5%. Ripple greater than this can lead to variations in the operating and reset voltages.

As excessive ripple can generate beats, the insertion of a smoothing capacitor is recommended as shown below.

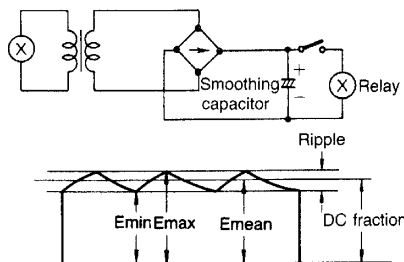

$$\% \text{ of ripple} = \frac{E_{\max} - E_{\min}}{E_{\text{mean}}} \times 100$$

E_{max}: Max. ripple
 E_{min}: Min. ripple
 E_{mean}: Mean DC value

- When driving a transistor, check the leakage current and connect a bleeder resistor if necessary.
- Momentary voltage drops on coil input voltage should not exceed one second duration after contact mating with no shock or vibration.



OMRON ELECTRONICS, INC.

One East Commerce Drive
 Schaumburg, IL 60173
1-800-55-OMRON

OMRON CANADA, INC.

885 Milner Avenue
 Scarborough, Ontario M1B 5V8
416-286-6465