

Power PCB Relay

G6C

- Subminiature 20.07 L x 14.99 W x 9.91 H mm
(0.79 L x 0.59 W x 0.39 H in)
- Low power consumption (200 mW)
- Semi-sealed and sealed types available
- Unique moving magnet armature (Moving Loop System) reduces relay size, magnetic interference, and contact bounce time
- Single and double-winding latching types available
- High sensitivity in a compact package
- Long life assured by high contact pressure

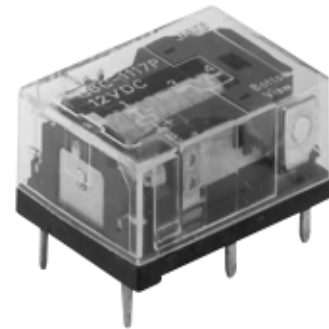

Ordering Information

To Order: Select the part number and add the desired coil voltage rating (e.g., G6C-1117P-US-DC6).

Type	Contact form	Construction	Part number
Non-latching	SPST-NO	Sealed	G6C-1114P-US
	SPST-NO + SPST-NC		G6C-2114P-US
	SPST-NO	Semi-sealed	G6C-1117P-US
	SPST-NO + SPST-NC		G6C-2117P-US
Single-winding latching contact	SPST-NO	Sealed	G6CU-1114P-US
	SPST-NO + SPST-NC		G6CU-2114P-US
	SPST-NO	Semi-sealed	G6CU-1117P-US
	SPST-NO + SPST-NC		G6CU-2117P-US
Dual-winding latching contact	SPST-NO	Sealed	G6CK-1114P-US
	SPST-NO + SPST-NC		G6CK-2114P-US
	SPST-NO	Semi-sealed	G6CK-1117P-US
	SPST-NO + SPST-NC		G6CK-2117P-US

ACCESSORIES

Back connecting sockets

Relay	Part number
G6C-1114P-US	P6C-06P
G6C-1117P-US	
G6C-2114P-US	
G6C-2117P-US	
G6CU-1114P-US	
G6CU-1117P-US	
G6CU-2114P-US	
G6CU-2117P-US	
G6CK-1114P-US	P6C-08P
G6CK-1117P-US	
G6CK-2114P-US	
G6CK-2117P-US	

Specifications

CONTACT DATA

Non-latching

Load	SPST-NO		SPST-NO + SPST-NC	
	Resistive load (p.f. = 1)	Inductive load (p.f. = 0.4) (L/R = 7 ms)	Resistive load (p.f. = 1)	Inductive load (p.f. = 0.4) (L/R = 7 ms)
Rated load	10 A at 250 VAC 10 A at 30 VDC	5 A at 250 VAC 5 A at 30 VDC	8 A at 250 VAC 8 A at 30 VDC	3.5 A at 250 VAC 3.5 A at 30 VDC
Contact material	AgCdO			
Carry current	10 A		8 A	
Max. operating voltage	380 VAC, 125 VDC			
Max. operating current	10 A		8 A	
Max. switching capacity	2,500 VA, 300 W	1,250 VA, 220 W	2,000 VA, 240 W	875 VA, 170 W
Min. permissible load	10 mA, 5 VDC			

Latching

Load	SPST-NO		SPST-NO + SPST-NC	
	Resistive load (p.f. = 1)	Inductive load (p.f. = 0.4) (L/R = 7 ms)	Resistive load (p.f. = 1)	Inductive load (p.f. = 0.4) (L/R = 7 ms)
Rated load	10 A at 250 VAC 10 A at 30 VDC	5 A at 250 VAC 5 A at 30 VDC	8 A at 250 VAC 8 A at 30 VDC	3.5 A at 250 VAC 3.5 A at 30 VDC
Contact material	AgCdO			
Carry current	10 A		8 A	
Max. operating voltage	380 VAC, 125 VDC			
Max. operating current	10 A		8 A	3.5 A
Max. switching capacity	2,500 VA, 300 W	1,250 VA, 220 W	2,000 VA, 240 W	875 VA, 105 W
Min. permissible load	10 mA, 5 VDC			

COIL DATA

Non-latching

Rated voltage (VDC)	Rated current (mA)	Coil resistance (Ω)	Coil inductance (ref. value) (H)		Pick-up voltage % of rated voltage	Dropout voltage 10% min.	Maximum voltage 160% max. at 23°C (73°F) 130% max. at 70°C (158°F)	Power consumption (mW)
			Armature OFF	Armature ON				
3	66.70	45	0.078	0.067	70% max.	10% min.	160% max. at 23°C (73°F) 130% max. at 70°C (158°F)	Approx. 200
5	40	125	0.22	0.18				
6	33.30	180	0.36	0.29				
12	16.70	720	1.32	1.13				
24	8.30	2,880	4.96	4.19				

Single-winding latching type

Rated voltage (VDC)	Rated current (mA)	Coil resistance (Ω)	Coil inductance (ref. value) (H)	Set pick-up voltage	Reset pick-up voltage	Maximum voltage 160% max. at 23°C (73°F) 130% max. at 70°C (158°F)	Power consumption (mW)
				% of rated voltage			
3	66.70	45	0.09	70% max.	70% min.	160% max. at 23°C (73°F) 130% max. at 70°C (158°F)	Approx. 200
5	40	125	0.25				
6	33.30	180	0.36				
12	16.70	720	1.75				
24	8.30	2,880	5.83				

Note: The rated current and coil resistance are measured at a coil temperature of 23°C (73°F) with a tolerance of ±10%.



■ COIL DATA

Dual-winding latching type

Rated voltage (VDC)	Rated current (mA)	Coil resistance (Ω)	Coil inductance (ref. value) (H)		Set pick-up voltage % of rated voltage	Reset pick-up voltage	Maximum voltage	Power consumption (mW)
			Set Coil	Reset Coil				
3	93.50	32.10	0.03	0.03	70% max.	70% max.	160% max. at 23°C (73°F) 110% max. at 70°C (158°F)	Approx. 280
5	56	89.30	0.07	0.08				
6	46.70	129	0.10	0.12				
12	23.30	514	0.37	0.47				
24	11.70	2,056	1.56	1.46				

- Note: 1. The rated current and coil resistance are measured at a coil temperature of 23°C (73°F) with a tolerance of $\pm 10\%$.
 2. Operating characteristics are measured at a coil temperature of 23°C (73°F).
 3. The minimum pulse width of the set and reset voltage is 20 ms.

■ CHARACTERISTICS

		Non-latching	Latching
Contact resistance		30 m Ω max.	
Operate (set) time		10 ms max. (mean value: approx. 5 ms)	
Release (reset) time		10 ms max. (mean value: approx. 2 ms)	
Bounce time	Operate	Approx. 3 ms	
	Release	Approx. 3 ms	
Operating frequency	Mechanical	18,000 operations/hour	
	Electrical	1,800 operations/hour (under rated load)	
Insulation resistance		1,000 M Ω min. (at 500 VDC)	
Dielectric strength		2,000 VAC, 50/60 Hz for 1 minute between coil and contacts, non-latching types	
		2,000 VAC, 50/60 Hz for 1 minute between contacts of different poles, non-latching	
		1,000 VAC, 50/60 Hz for 1 minute between contacts of same pole, non-latching	
		250 VAC, 50/60 Hz for 1 minute between set and reset coils, latching types	
Surge withstand voltage		4,500 V x 40 μ s (between coil and contacts, non-latching)	
Vibration	Mechanical durability	10 to 55 Hz; 1.50 mm (0.06 in) double amplitude	
	Malfunction durability	10 to 55 Hz; 1.50 mm (0.06 in) double amplitude	
Shock	Mechanical durability	Approx. 100 G	
	Malfunction durability	Approx. 10 G	
Ambient temperature		-25 to 70°C (-13° to 158°F)	
Humidity		45 to 85% RH	
Service life	Mechanical	50 million operations min. (at operating frequency of 18,000 operations/hour)	
	Electrical	See "Characteristic Data"	
Weight		Approx. 5.6 g (0.20 oz)	

Note: Data shown are of initial value.

CHARACTERISTIC DATA

Non-latching types

Maximum switching capacity

SPST-NO

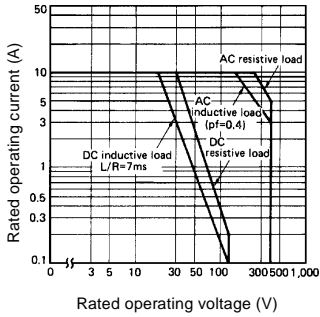

SPST-NO + SPST-NC

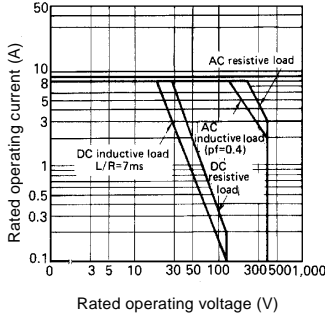

Electrical service life

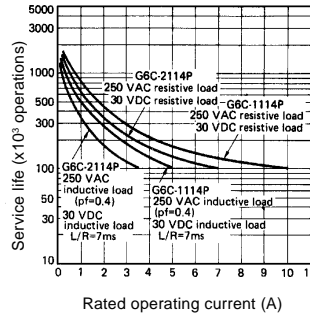

Ambient temperature vs. maximum voltage (reference only)

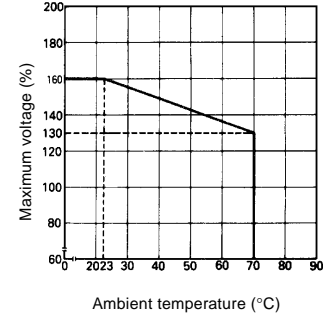

Latching types

Maximum switching capacity

SPST-NO

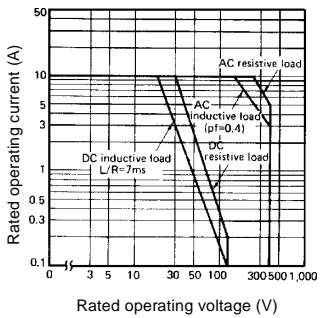

SPST-NO + SPST-NC

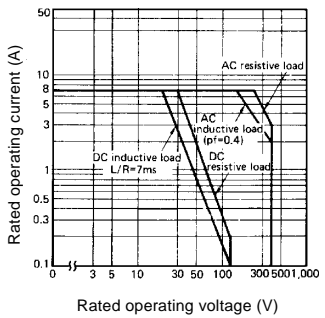

Electrical service life

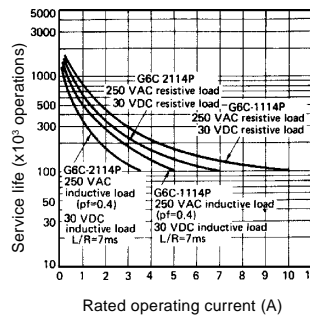

Ambient temperature vs. maximum voltage (reference only)

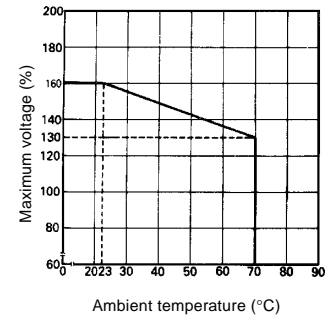

Dimensions

Unit: mm (inch)

NON-LATCHING RELAYS

G6C-□117P-US

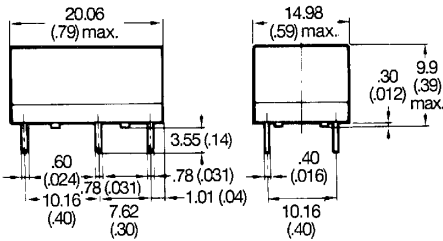

**Terminal arrangement/
Internal connections**
(Bottom view)

G6C-1117P-US, G6C-1114P-US

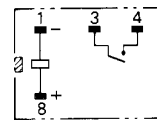

Mounting holes

[Bottom view, Tolerance: ±2.54 (0.10)]

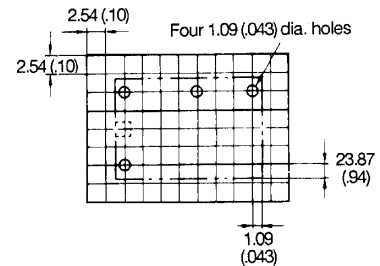

Note: [Hatched pattern] and [Dashed box] indicate mounting orientation marks.



G6C-□114P-US

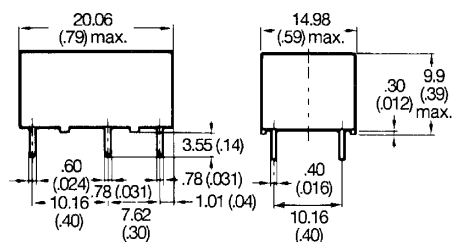

**Terminal arrangement/
Internal connections**
(Bottom view)

G6C-2117P-US, G6C-2114P-US

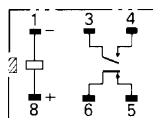

Mounting holes
(Bottom view, Tolerance: ± 2.54 [0.10])

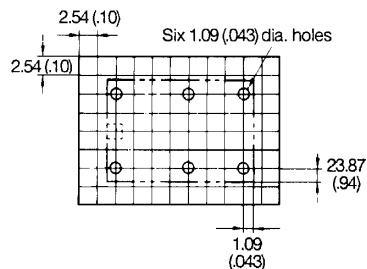

■ **LATCHING RELAYS**

Single winding types, 1-pole
G6CU-1117P-US, G6CU-1114P-US

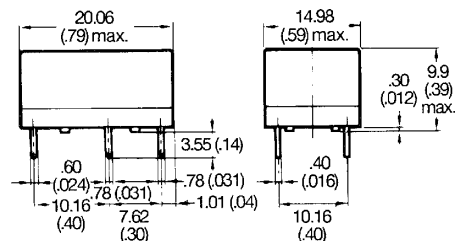

**Terminal arrangement/
Internal connections**
(Bottom view)

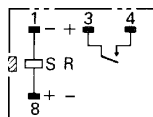

Mounting holes
(Bottom view)

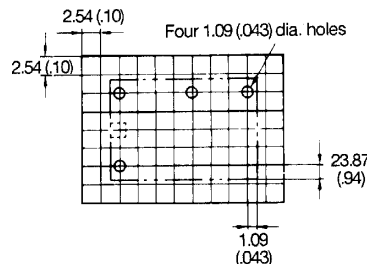

Single winding types, 2-pole
G6CU-2117P-US, G6CU-2114P-US

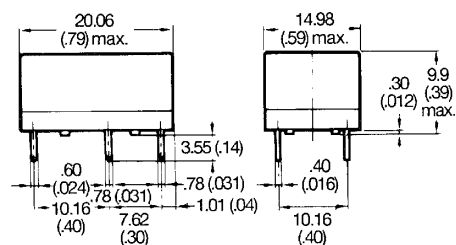

**Terminal arrangement/
Internal connections**
(Bottom view)

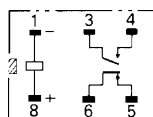

Mounting holes
(Bottom view)

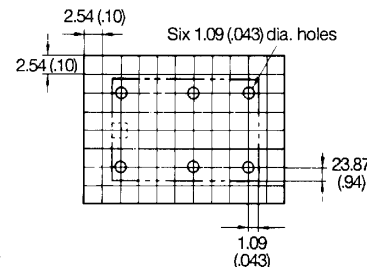

Note: and indicate mounting orientation marks.

Unit: mm (inch)

■ **LATCHING RELAYS (continued)**

Double winding types, 1-pole
G6CK-1117P-US, G6CK-1114P-US

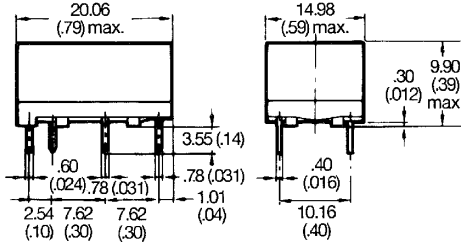

Terminal arrangement/
Internal connections
(Bottom view)

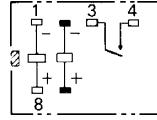

Mounting holes
(Bottom view)

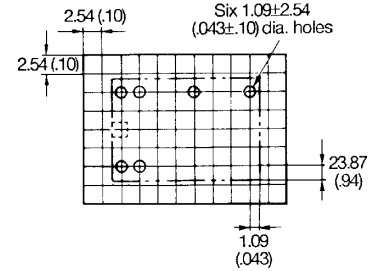

Double winding types, 2-pole
G6CK-2117P-US, G6CK-2114P-US

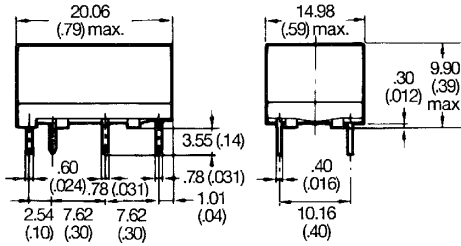

Terminal arrangement/
Internal connections
(Bottom view)

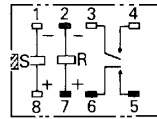

Mounting holes
(Bottom view)

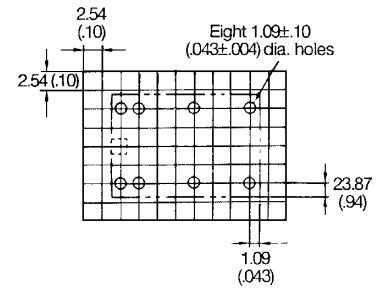

■ **ACCESSORIES**

Connecting sockets – P6C-06P, P6C-08P

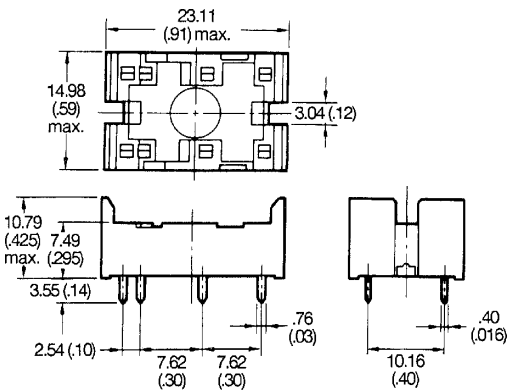

Mounting height of relay
width connecting socket

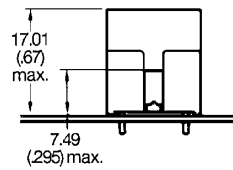

Mounting holes
(Bottom view)

P6C-06P

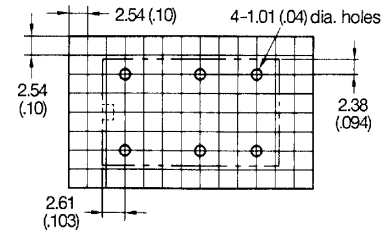

P6C-08P

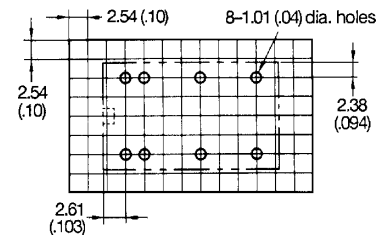

Note: and indicate mounting orientation marks.



■ APPROVALS

UL (File No. E41643)/ CSA (File No. LR31928)

Type	Contact Form	Coil Rating	Contact Ratings
G6C-1114P-US G6C-1117P-US	SPST-NO	3 to 60 VDC	10 A, 250 VAC (General purpose) 10 A, 30 VDC (Resistive) TV-5 1/4 HP, 125 VAC 1/4 HP, 250 VAC (Motor load) 1/3 HP, 250 VAC (Motor load) 600 WT, 120 VAC (Tungsten) 530 VA, 265 VAC, 2 A max. pilot duty 43.2 VA, 30 VDC, pilot duty 22 LRA, 3.6 FLA, 30 VDC
G6C-2114P-US G6C-2117P-US	SPST-NO + SPST-NC	3 to 60 VDC	8 A, 250 VAC (General purpose) 8 A, 30 VDC (Resistive) TV-5 1/4 HP, 125 VAC 1/4 HP, 250 VAC (Motor load) 600 WT, 120 VAC (Tungsten) 530 VA, 265 VAC, 2 A max. pilot duty 43.2 VA, 30 VDC, pilot duty 22 LRA, 3.6 FLA, 30 VDC
G6C(U/K)-1114P-US G6C(U/K)-1117P-US	SPST-NO	3 to 60 VDC	10 A, 250 VAC (General purpose) 10 A, 30 VDC (Resistive) 1/6 HP, 125 VAC (Motor load) TV-5 1/4 HP, 125 VAC 1/4 HP, 250 VAC (Motor load) 1/3 HP, 250 VAC (Motor load) 600 WT, 120 VAC (Tungsten)
G6C(U/K)-2114P-US G6C(U/K)-2117P-US	SPST-NO + SPST-NC	3 to 60 VDC	8 A, 250 VAC (General purpose) 8 A, 30 VDC (Resistive) 1/6 HP, 125 VAC (Motor load) TV-5 1/4 HP, 125 VAC 1/4 HP, 250 VAC (Motor load) 1/3 HP, 250 VAC (Motor load) 600 WT, 120 VAC (Tungsten)

VDE (File No. 2314)

Type	Contact Form	Coil Rating	Contact Ratings
G6C-1117P-VD G6C-1114P-VD	SPST-NO	DC3, 12, 24V	250 VAC 10 A (Resistive) 5 A (Inductive)
G6C-2117P-VD G6C-2114P-VD	SPST-NO + SPST-NC	DC3, 12, 24V	250 VAC 7 A (Resistive) 3.5 A (Inductive)

- Note: 1. The rated values approved by each of the safety standards (e.g., UL and CSA) may be different from the performance characteristics individually defined in this catalog.
2. In the interest of product improvement, specifications are subject to change.

OMRON

OMRON ELECTRONICS, INC.

One East Commerce Drive
Schaumburg, IL 60173

1-800-55-OMRON

OMRON CANADA, INC.

885 Milner Avenue
Scarborough, Ontario M1B 5V8

416-286-6465

Cat. No. GC RLY6

9/97

Specifications subject to change without notice.

Printed in the U.S.A.