

Solid State Relay

G3NE

Compact, Low-cost, SSR Switching
5 to 20 A

- Wide load voltage range: 75 to 264 VAC
- Dedicated, compact aluminum PCB and power elements used
- Built-in varistor effectively absorbs external surges.
- Quick-connect #110 input terminals and #250 output connections. (#187 input terminals available)
- Approved by UL and CSA

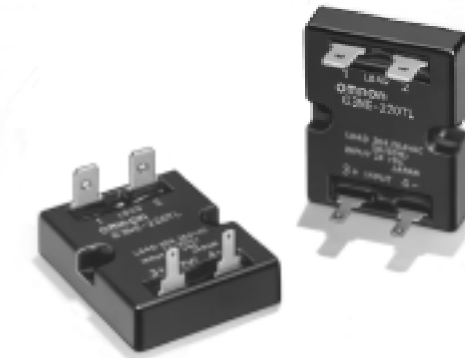

Ordering Information

To order: Select the part number and add the desired coil voltage rating, (e.g., G3NE-205T-US DC24)

Isolation	Zero cross function	Indicator	Rated output load (applicable output load)	Rated input voltage	Part number
Phototriac	Yes	No	5 A at 100 to 240 VAC (5 A at 75 to 264 VAC)	5, 12, 24 VDC	G3NE-205T-US
			10 A at 100 to 240 VAC (10 A at 75 to 264 VAC)		G3NE-210T-US
			20 A at 100 to 240 VAC (20 A at 75 to 264 VAC)		G3NE-220T-US
	No		5 A at 100 to 240 VAC (5 A at 75 to 264 VAC)		G3NE-205TL-US
			10 A at 100 to 240 VAC (10 A at 75 to 264 VAC)		G3NE-210TL-US
			20 A at 100 to 240 VAC (20 A at 75 to 264 VAC)		G3NE-220TL-US

Note: For information on ordering #187 input terminals contact your local Omron representative

■ ACCESSORIES (ORDER SEPARATELY)

Heat Sink

The following heat sinks are thin and can be track-mounted.
See *Dimensions* for details.

Part number	Applicable SSR
Y92B-N50	G3NE-205T(L)/-210T(L)
Y92B-N100	G3NE-220T(L)

Specifications

■ RATINGS

Input

Rated voltage	Operating voltage	Voltage level		Input impedance	
		Must operate	Must release	With zero cross function	Without zero cross function
5 VDC	4 to 6 VDC	4 VDC max.	1 VDC min.	250 Ω \pm 20%	300 k Ω \pm 20%
12 VDC	9.6 to 14.4 VDC	9.6 VDC max.		600 Ω \pm 20%	800 k Ω \pm 20%
24 VDC	19.2 to 28.8 VDC	19.2 VDC max.		1.6 k Ω \pm 20%	

Note: Each model has 5-VDC, 12-VDC, and 24-VDC input versions.

Output

Part number	Applicable load				
	Rated load voltage	Load voltage range	Load current		Inrush current
			With heat sink	Without heat sink	
G3NE-205T(L)-US	100 to 240 VAC	75 to 264 VAC	0.1 to 5 A	0.1 to 5 A	60 A (60 Hz, 1 cycle)
G3NE-210T(L)-US			0.1 to 10 A (see note)	0.1 to 5 A	150 A (60 Hz, 1 cycle)
G3NE-220T(L)-US			0.1 to 20 A (see note)	0.1 to 5 A	220 A (60 Hz, 1 cycle)

Note: These values apply when using a dedicated radiator or a radiation plate of specified size.

■ CHARACTERISTICS

Item	G3NE-2□□T-US	G3NE-2□□TL-US
Operate time	1/2 of load power source cycle + 1 ms max.	1 ms max.
Release time	1/2 of load power source cycle + 1 ms max.	
Output ON voltage drop	1.6 V (RMS) max.	
Leakage current	5 mA max. (at 100 VAC) 10 mA max. (at 200 VAC)	
Insulation resistance	100 M Ω min. (at 500 VDC)	
Dielectric strength	2,000 VAC, 50/60 Hz for 1 min	
Vibration resistance	Malfunction: 10 to 55 Hz, 1.5-mm double amplitude	
Shock resistance	Malfunction: 1,000 m/s ² {approx. 100G}	
Ambient temperature	Operating: -30°C to 80°C (with no icing nor condensation) Storage: -30°C to 100°C (with no icing nor condensation)	
Ambient humidity	Operating: 45% to 85%	
Approved standards	UL508 File No.E64562/CSA C22.2 (No.0, No.14) File No. LR35535 TÜV R9051064 (VDE0435) (EN60950)	
Weight	Approx. 37 g	

Engineering Data

Load Current vs. Ambient Temperature Characteristics

G3NE-205T(L)-US

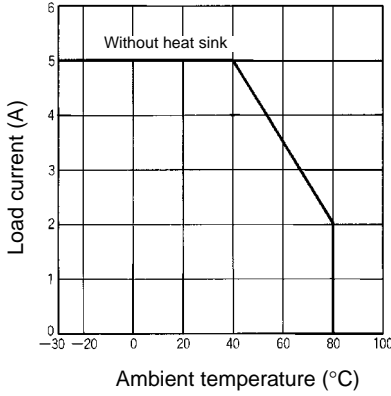

G3NE-210T(L)-US

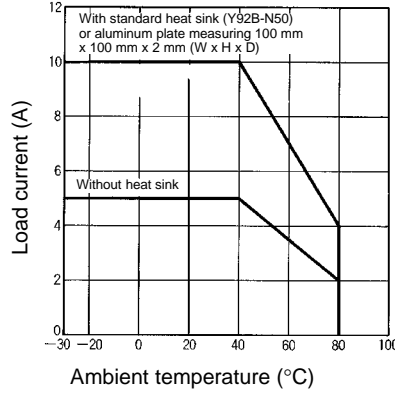

G3NE-220T(L)-US

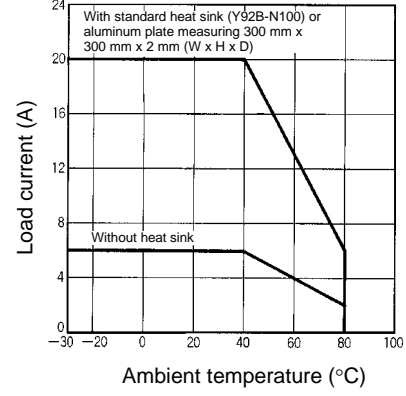

Inrush Current Resistivity

Non-repetitive (Keep the inrush current to half the rated value if it occurs repetitively.)

G3NE-205T(L)-US

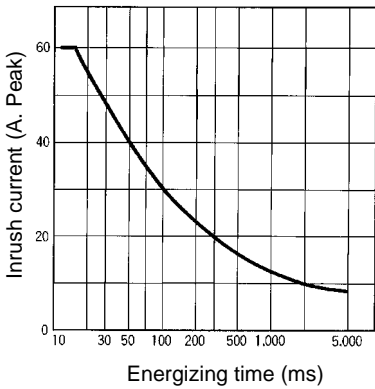

G3NE-210T(L)-US

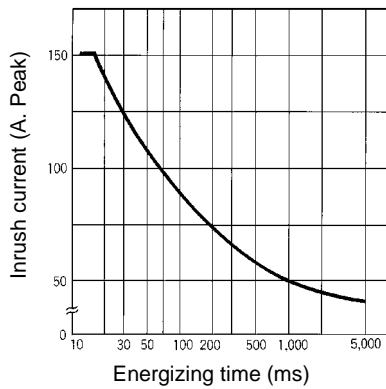

G3NE-220T(L)-US

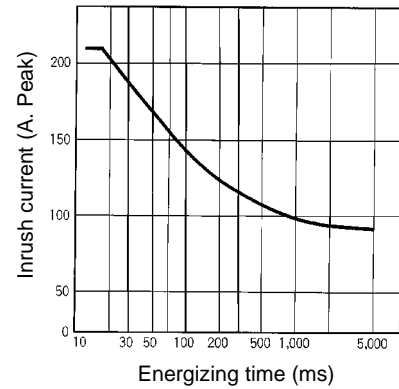

Dimensions

Unit: mm (inch)

G3NE-205T(L)/210T(L)/220T(L)-US

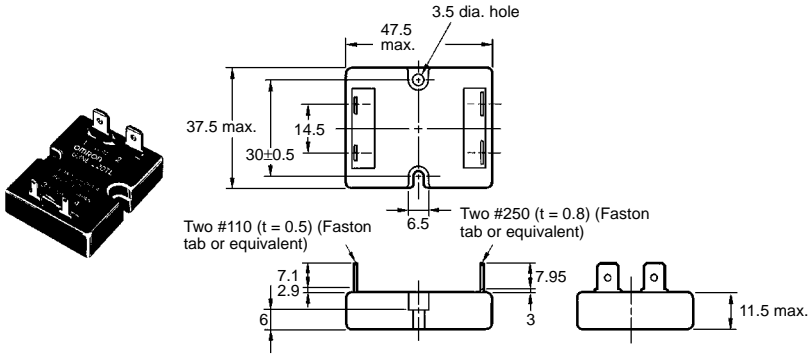

Terminal Arrangement/ Internal Connections (Top View)

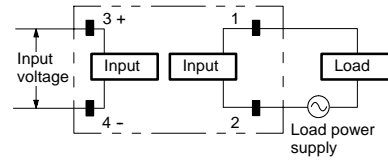

Mounting Holes

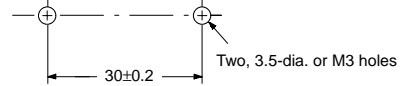

Heat Sink Y92B-N50

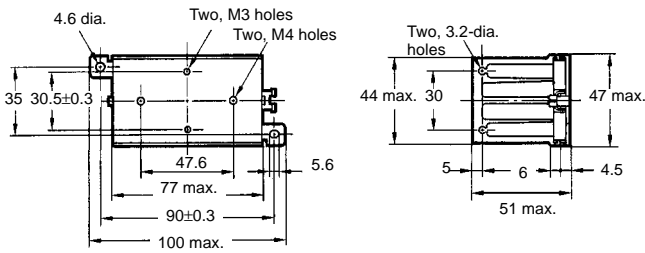
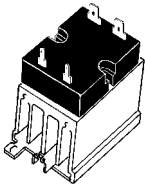

Mounting Holes

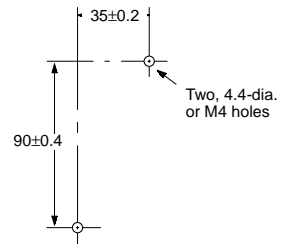

Weight: approx. 200 g

Y92B-N100

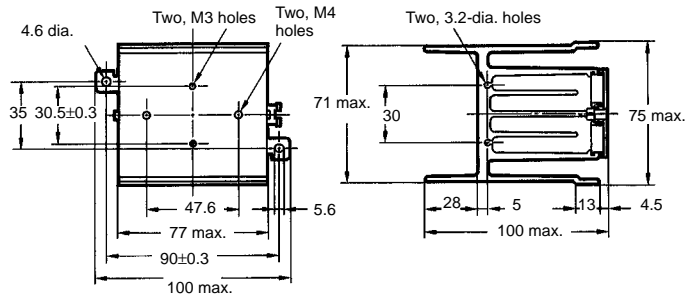
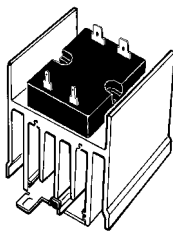

Mounting Holes

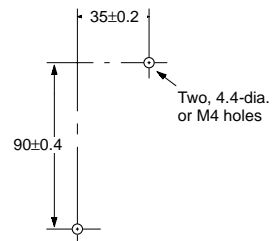

Weight: approx. 400 g

NOTE: DIMENSIONS SHOWN ARE IN MILLIMETERS. To convert millimeters to inches divide by 25.4.

OMRON®
OMRON ELECTRONICS, INC.
One East Commerce Drive
Schaumburg, IL 60173
1-800-55-OMRON

OMRON CANADA, INC.
885 Milner Avenue
Scarborough, Ontario M1B 5V8
416-286-6465