

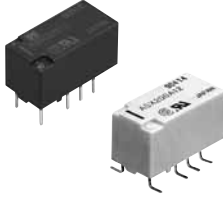

Panasonic
ideas for life

**HIGH SENSIBILITY RELAY
WITH GUARANTEED
LOW LEVEL SWITCHING
CAPACITY**

SX RELAYS (ASX)



FEATURES

1. High contact reliability over a long life has been made possible for low level loads.

Using a low level load (1 mV 10 μ A to 10 V 10 mA) 10⁷ operations were achieved with a static contact resistance of Max. 100 m Ω (voltage drop of 20 mV, 1 mA, 1 kHz) and a dynamic contact resistance of Max. 1 Ω (Measurement delay 10 ms, voltage drop of 20 mV, 1 mA, 1 kHz).

2. High sensibility of 50 mW

By using the highly efficient polar magnetic circuit "seesaw balance armature mechanism", a rated power consumption of 50 mW (for single side stable type) has been achieved.

3. Low thermal electromotive force

Reducing the heat from the coil enables a thermal electromotive force of 3 μ V or less.

TYPICAL APPLICATIONS

This relay will be used for the low level load for measuring instruments or others where a stable contact resistance is required.

RoHS Directive compatibility information
<http://www.mew.co.jp/ac/e/environment/>

ORDERING INFORMATION

ASX	2		0				
Contact arrangement 2: 2 Form C							
Operating function 0: Single side stable 1: 1 coil latching 2: 2 coil latching							
Type of operation 0: Standard type (B.B.M.)							
Terminal shape Nil: Standard PC board terminal A: Surface-mount terminal (A type)							
Coil voltage (DC) 1H: 1.5V 03: 3V 4H: 4.5V 06: 6V 09: 9V 12: 12V 24: 24V							
Packing style Nil: Tube packing X: Tape and reel packing (picked from 1/3/4/5 pin side) Z: Tape and reel packing (picked from 8/9/10/12 pin side)							

TYPES

1. Standard PC board terminal

Contact arrangement	Nominal coil voltage	Single side stable	1 coil latching	2 coil latching
		Part No.	Part No.	Part No.
2 Form C	1.5V DC	ASX2001H	ASX2101H	ASX2201H
	3V DC	ASX20003	ASX21003	ASX22003
	4.5V DC	ASX2004H	ASX2104H	ASX2204H
	6V DC	ASX20006	ASX21006	ASX22006
	9V DC	ASX20009	ASX21009	ASX22009
	12V DC	ASX20012	ASX21012	ASX22012
	24V DC	ASX20024	ASX21024	ASX22024

Standard packing: Tube: 40 pcs.; Case: 1,000 pcs.

SX (ASX)**2. Surface-mount terminal****1) Tube packing**

Contact arrangement	Nominal coil voltage	Single side stable	1 coil latching	2 coil latching
		Part No.	Part No.	Part No.
2 Form C	1.5V DC	ASX200A1H	ASX210A1H	ASX220A1H
	3V DC	ASX200A03	ASX210A03	ASX220A03
	4.5V DC	ASX200A4H	ASX210A4H	ASX220A4H
	6V DC	ASX200A06	ASX210A06	ASX220A06
	9V DC	ASX200A09	ASX210A09	ASX220A09
	12V DC	ASX200A12	ASX210A12	ASX220A12
	24V DC	ASX200A24	ASX210A24	ASX220A24

Standard packing: Tube: 40 pcs.; Case: 1,000 pcs.

2) Tape and reel packing

Contact arrangement	Nominal coil voltage	Single side stable	1 coil latching	2 coil latching
		Part No.	Part No.	Part No.
2 Form C	1.5V DC	ASX200A1HZ	ASX210A1HZ	ASX220A1HZ
	3V DC	ASX200A03Z	ASX210A03Z	ASX220A03Z
	4.5V DC	ASX200A4HZ	ASX210A4HZ	ASX220A4HZ
	6V DC	ASX200A06Z	ASX210A06Z	ASX220A06Z
	9V DC	ASX200A09Z	ASX210A09Z	ASX220A09Z
	12V DC	ASX200A12Z	ASX210A12Z	ASX220A12Z
	24V DC	ASX200A24Z	ASX210A24Z	ASX220A24Z

Standard packing: Tape and reel: 500 pcs.; Case: 1,000 pcs.

Note: Tape and reel packing symbol "Z" is not marked on the relay. "X" type tape and reel packing (picked from 1/3/4/5-pin side) is also available.

RATING**1. Coil data****1) Single side stable type**

Nominal coil voltage	Pick-up voltage (at 20°C 68°F)	Drop-out voltage (at 20°C 68°F)	Nominal operating current [±10%] (at 20°C 68°F)	Coil resistance [±10%] (at 20°C 68°F)	Nominal operating power	Max. allowable voltage (at 20°C 68°F)
1.5V DC	80%V or less of nominal voltage* (Initial)	10%V or more of nominal voltage* (Initial)	33.3mA	45Ω	50mW	150%V of nominal voltage
3V DC			16.7mA	180Ω		
4.5V DC			11.1mA	405Ω		
6V DC			8.3mA	720Ω		
9V DC			5.6mA	1,620Ω		
12V DC			4.2mA	2,880Ω		
24V DC			2.9mA	8,229Ω	70mW	

2) 1 coil latching type

Nominal coil voltage	Set voltage (at 20°C 68°F)	Reset voltage (at 20°C 68°F)	Nominal operating current [±10%] (at 20°C 68°F)	Coil resistance [±10%] (at 20°C 68°F)	Nominal operating power	Max. allowable voltage (at 20°C 68°F)
1.5V DC	80%V or less of nominal voltage* (Initial)	80%V or less of nominal voltage* (Initial)	23.3mA	64.3Ω	35mW	150%V of nominal voltage
3V DC			11.7mA	257Ω		
4.5V DC			7.8mA	579Ω		
6V DC			5.8mA	1,029Ω		
9V DC			3.9mA	2,314Ω		
12V DC			2.9mA	4,114Ω		
24V DC			2.1mA	11,520Ω	50mW	

3) 2 coil latching type

Nominal coil voltage	Set voltage (at 20°C 68°F)	Reset voltage (at 20°C 68°F)	Nominal operating current [±10%] (at 20°C 68°F)		Coil resistance [±10%] (at 20°C 68°F)		Nominal operating power		Max. allowable voltage (at 20°C 68°F)
			Set coil	Reset coil	Set coil	Reset coil	Set coil	Reset coil	
1.5V DC	80%V or less of nominal voltage* (Initial)	80%V or less of nominal voltage* (Initial)	46.7mA	46.7mA	32.1Ω	32.1Ω	70mW	70mW	150%V of nominal voltage
3V DC			23.3mA	23.3mA	129Ω	129Ω			
4.5V DC			15.6mA	15.6mA	289Ω	289Ω			
6V DC			11.7mA	11.7mA	514Ω	514Ω			
9V DC			7.8mA	7.8mA	1,157Ω	1,157Ω			
12V DC			5.8mA	5.8mA	2,057Ω	2,057Ω			
24V DC			6.3mA	6.3mA	3,840Ω	3,840Ω	150mW	150mW	

*Pulse drive (JIS C 5442-1996)

2. Specifications

Characteristics	Item	Specifications	
Contact	Arrangement	2 Form C	
	Static contact resistance (During initial and electric life tests)	Max. 100 mΩ (By voltage drop of 20 mV 1 mA [1kHz]) (By nominal switching capacity: No. of operations: 10 ⁷)	
	Dynamic contact resistance (During initial and electric life tests)	Max. 1 Ω (By voltage drop of 20 mV 1 mA [1 kHz], Measurement delay 10 ms after applying nominal coil voltage) (By nominal switching capacity: No. of operations: 10 ⁷)	
	Contact material	Stationary contact: AgPd+Au clad Movable contact: AgPd	
Rating	Nominal switching capacity (resistive load)	10 mA 10 V DC	
	Max. switching power	0.1 W	
	Max. switching voltage	10 V DC	
	Max. switching current	10 mA DC	
	Min. switching capacity (Reference value)*1	10 μA 1 mV DC	
	Nominal operating power	Single side stable 1 coil latching 2 coil latching	50mW (1.5 to 12 V DC), 70mW (24 V DC) 35mW (1.5 to 12 V DC), 50mW (24 V DC) 70mW (1.5 to 12 V DC), 150mW (24 V DC)
Electrical characteristics	Insulation resistance (Initial)	Min. 10,000MΩ (at 500V DC) Measurement at same location as "Initial breakdown voltage" section.	
	Breakdown voltage (Initial)	Between open contacts	750 Vrms for 1min. (Detection current: 10mA)
		Between contact and coil	1,000 Vrms for 1min. (Detection current: 10mA)
		Between contact sets	1,000 Vrms for 1min. (Detection current: 10mA)
	Surge breakdown voltage (Initial)	Between open contacts	1,500 V (10×160μs) (FCC Part 68)
		Between contacts and coil	2,500 V (2×10μs) (Telcordia)
	Temperature rise (at 20°C 68°F)	Max. 50°C (By resistive method, nominal voltage applied to the coil; contact carrying current: 10mA.)	
Operate time [Set time] (at 20°C 68°F)	Max. 5 ms [Max. 5 ms] (Nominal voltage applied to the coil, excluding contact bounce time.)		
Release time [Reset time] (at 20°C 68°F)	Max. 5 ms [Max. 5 ms] (Nominal voltage applied to the coil, excluding contact bounce time.) (without diode)		
Mechanical characteristics	Shock resistance	Functional	Min. 750 m/s ² (Half-wave pulse of sine wave: 6 ms; detection time: 10μs.)
		Destructive	Min. 1,000 m/s ² (Half-wave pulse of sine wave: 6 ms.)
	Vibration resistance	Functional	10 to 55 Hz at double amplitude of 3.3 mm (Detection time: 10μs.)
		Destructive	10 to 55 Hz at double amplitude of 5 mm
Expected life	Mechanical	Min. 5 × 10 ⁷ (at 750 cpm)	
	Electrical	Min. 10 ⁷ (10 mA 10 V DC resistive load) (at 750 cpm)	
Thermal electromotive force		Max. 3μV (at nominal voltage applied to the coil)	
Conditions	Conditions for operation, transport and storage*2	Ambient temperature: -40°C to +70°C -40°F to +158°F Humidity: 5 to 85% R.H. (Not freezing and condensing at low temperature)	
	Max. operating speed (at rated load)	750 cpm	
Unit weight		Approx. 2 g .071 oz	

Notes: *1 This value can change due to the switching frequency, environmental conditions, and desired reliability level, therefore it is recommended to check this with the actual load.

*2 Refer to 6. Conditions for operation, transport and storage mentioned in AMBIENT ENVIRONMENT.

REFERENCE DATA

1. Switching capacity range

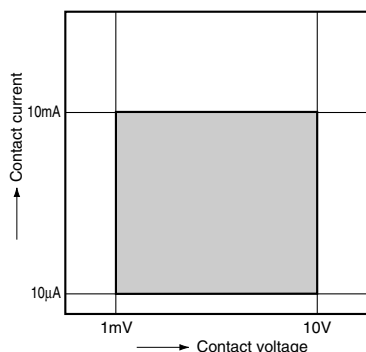

2-(1). Change in dynamic contact resistance (10 mA 10 V DC resistive load)

Tested sample: ASX20012, 10 pcs.
Operating speed: 750 cpm
Measured condition: 10 ms after applying nominal coil voltage, using voltage drop of 20 mV, 1 mA, 1 kHz.

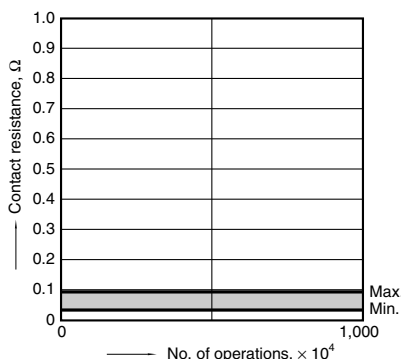

2-(2). Change in dynamic contact resistance (10 μA 1 mV DC resistive load)

Tested sample: ASX20012, 10 pcs.
Operating speed: 750 cpm
Measured condition: 10 ms after applying nominal coil voltage, using voltage drop of 20 mV, 1 mA, 1 kHz.

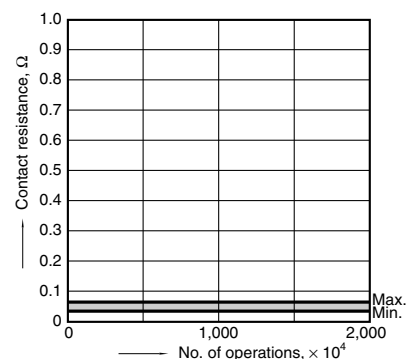

SX (ASX)

3-(1). Change in static contact resistance
(10 mA 10 V DC resistive load)
Tested sample: ASX20012, 10 pcs.
Operating speed: 750 cpm

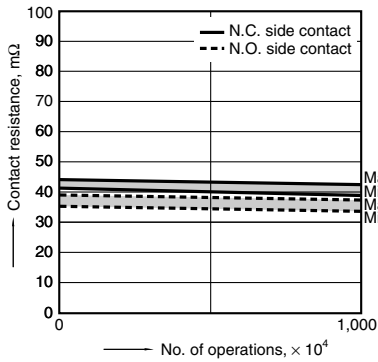

3-(2). Change in static contact resistance
(10 μA 1 mV DC resistive load)
Tested sample: ASX20012, 10 pcs.
Operating speed: 750 cpm

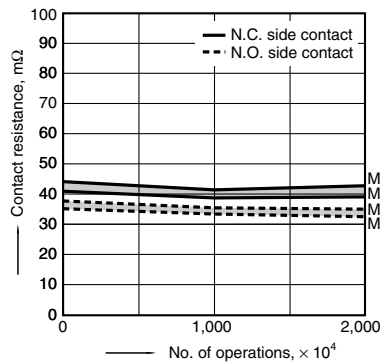

DIMENSIONS (Unit: mm inch)

1. Standard PC board terminal



External dimensions (General tolerance: $\pm 0.3 \pm 0.12$)		PC board pattern (Tolerance: $\pm 0.1 \pm 0.04$)	
Single side stable/1 coil latching	2 coil latching	Single side stable/1 coil latching	2 coil latching

Schematic (Bottom view)

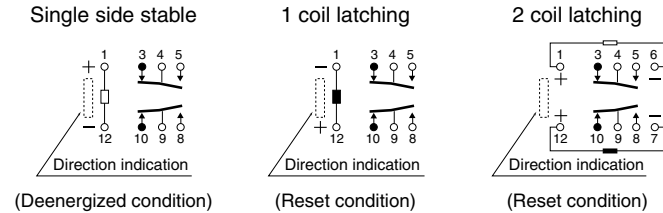

2. Surface-mount terminal



Type	External dimensions (General tolerance: $\pm 0.3 \pm 0.12$)		Suggested mounting pad (Tolerance: $\pm 0.1 \pm 0.04$)	
	Single side stable/1 coil latching	2 coil latching	Single side stable/1 coil latching	2 coil latching
A type				

Schematic (Top view)

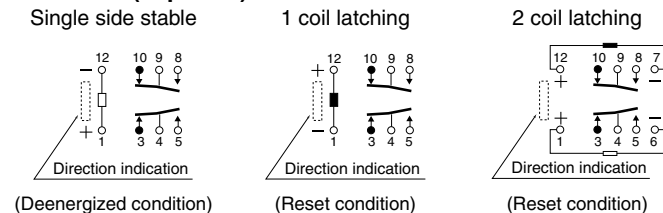

NOTES

1. Coil operating power

1) As a general rule, only a pure DC power supply should be used for the coil drive.

2) To ensure proper operation, the voltage applied to both terminals of the coil should be $\pm 5\%$ (at 20°C 68°F) the rated operating voltage of the coil. Also, be aware that the pick-up and drop-out voltages will fluctuate depending on the ambient temperature and operating conditions.

3) The ripple factor for the voltage applied to the coil should be less than 5%.

4) For set and reset latching relays, the rated operating voltage should be applied to the coil for 10 ms or more.

2. Coil connection

When connecting coils, refer to the wiring diagram to prevent mis-operation or malfunction.

3. External magnetic field

Since SX relays are highly sensitive polarized relays, their characteristics will be affected by a strong external magnetic field. Avoid using the relay under that condition.

4. Cleaning

In automatic cleaning, cleaning with the boiling method is recommended. Avoid ultrasonic cleaning which subject the relay to high frequency vibrations. It may cause the contacts to stick.

It is recommended that a fluorinated hydrocarbon or other alcoholic solvent be used.

5. Packing style

1) The relay is packed in a tube with the relay orientation mark on the left side, as shown in the figure below.

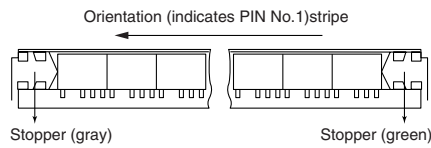

2) Tape and reel packing

(A type)

(1) Tape dimensions

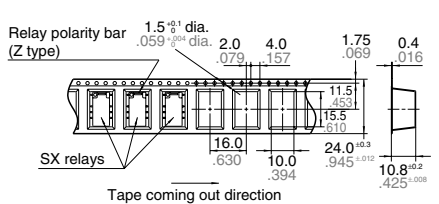

(2) Dimensions of plastic reel

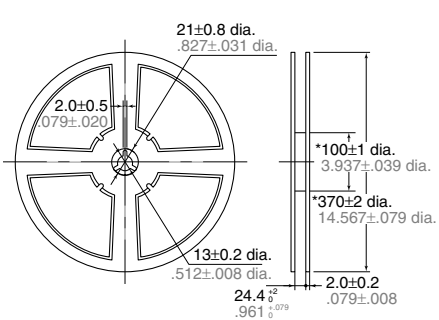

Note: Dimensions of items produced after December 2006 have changed as shown below.
 100^{±1} dia. 3.937^{±.039} dia. → 80^{±1} dia. 3.150^{±.039} dia.;
 370^{±2} dia. 14.567^{±.079} dia. → 380^{±2} dia. 14.961^{±.079} dia.

6. Automatic insertion

To maintain the internal function of the relay, the chucking pressure should not exceed the values below.

Chucking pressure in the direction A: 4.9 N {500gf} or less

Chucking pressure in the direction B: 9.8 N {1 kgf} or less

Chucking pressure in the direction C: 9.8 N {1 kgf} or less

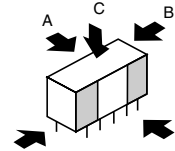

Please chuck the  portion. Avoid chucking the center of the relay. In addition, excessive chucking pressure to the pinpoint of the relay should be avoided.

For Cautions for Use, see Relay Technical Information.