

NAIS

HIGH VOLTAGE AND CURRENT CUT-OFF CAPACITY IN A COMPACT PACKAGE

EP-RELAYS



150A 2 Form A



150A 1 Form A



60A

FEATURES

- **Control of large voltages and currents**

The relays have a sealed construction that is filled with a hydrogen gas compound, and use a permanent magnet to establish a magnetic path for the arc. This allows them to switch high-level DC voltages of up to 400V DC.

- **Compact size and light weight**

The capsule contact construction is filled with a gas that has excellent thermal dissipation and insulation characteristics.

Because of this we have been able to reduce the contact gap to one tenth that of conventional relays, and produce a compact and light design.

- **No arc space is required: size including arc space 1/9 (compared to conventional contactors)**

The arc is not exposed to the outside, therefore, no arc space is not required.

- **Safety construction**

The arc is not exposed, therefore, the contactor is explosion proof and intrinsically safe.

- **Quiet: operation noise 1/4 (compared to conventional contactors).**

Along with the above-mentioned miniaturization, the operation noise has been reduced to 70dB, and, in addition, the operation noise remains unchanged when a current of 1000A or more is interrupted.

- **High contact reliability**

The contact part is hermetically sealed, hence the contact resistance remains stable regardless of the ambient conditions.

- **Mounting direction is not specified**

The weight of the movable parts is light, and also the restoring force is large, hence the contactor is relatively unaffected by gravity.

- **Line-up of indicator types (150A Type only)**

1 Form A and 1 Form B types with indicators for detecting welding of the main contacts are available.

- **12 and 24V DC coil voltage types are available.**

- **Screw terminal blocks for easy wiring.**

SPECIFICATIONS

Contact

Type		150A type	60A type
Arrangement		1 Form A, 2 Form A	1 Form A
Rating	Nominal switching capacity (resistive load)	150A 400V DC 150A 277V AC	60A 400V DC 60A 277V AC
	Short term current	300A (10min)(harness wire: 40mm ²)	120A (15min)(harness wire: 15mm ²)
	Max. cut-off current	2,500A 300V DC (3 cycles) ^{#1}	600A 300V DC (5 cycles)
	Overload opening/closing rating	600A 400V DC (Min. 1,000 cycles)	180A 400V DC (Min. 100 cycles) ^{#2}
	Reverse cut-off current	-200A 200V DC (Min. 500 cycles)	-60A 200V DC (Min. 1,000 cycles) ^{#2}
	Contact voltage drop (Max.)	0.1V (When current [is 150A per 1] contact set)	0.1V (When current [is 60A per 1] contact set)
	Nominal operating power	35W (Inrush, approx 0.1s) 5W (Stable)	Max. 5W
Expected life (min. operations)	Mechanical	10 ⁵	2 × 10 ⁵
	Electrical	3 × 10 ³ 150A 400V DC (L/R ≤ 1ms)	3 × 10 ³ 60A 400V DC (L/R ≤ 1ms) ^{#2}

Notes:

Same specifications as the 12 V type.

^{#1} Condition: Nominal switching 100cycles, each cut off 2,500A

^{#2} Conditions: Varistor used for coil surge absorption. Note: if a diode is used the life will be lower.

Characteristics

Initial insulation resistance		Min. 100 MΩ (at 500 V DC)* ¹
Initial breakdown voltage	Between open contacts	AC 2,500 Vrms for 1 min.* ²
	Between contact and coil	AC 2,500 Vrms for 1 min.* ²
Operate time (at 20°C) (at nominal voltage)		Max. 50ms* ³
Reset time (without diode) (at 20°C) (at nominal voltage)		Max. 30ms* ⁴
Shock resistance	Functional	Min. 196 m/s ² {20 G}* ⁵
	Destructive	Min. 490 m/s ² {50 G}* ⁶
Vibration resistance	Functional	43 m/s ² {4.4 G} 10 to 200Hz* ⁷
	Destructive	43 m/s ² {4.4 G} 10 to 200 Hz* ⁸
Conditions for operation, transport and storage (Not freezing and condensing at low temperature)	Ambient temperature	-40°C to +80°C* ⁹ -40°F to +176°F
	Humidity	5 to 85% R.H.
Unit weight		150 A 1 Form A: 600 g 21.16oz 150 A 2 Form A: 1,100 g 38.80oz 60 A: 340 g 12.00oz

Remarks:

*¹ Measurement at same location as "Initial breakdown voltage" section.

*² Detection current: 10mA.

*³ Nominal voltage applied to the coil, excluding bounce time.

*⁴ Nominal voltage applied to the coil.

*⁵ Half-wave pulse of sine wave: 11 ms; detection time: 10μs.

*⁶ Half-wave pulse of sine wave: 6 ms.

*⁷ Detection time: 10 μs.

*⁸ 3 directions, each 4 hours.

*⁹ Storage: Max.85°C 185°F.

Indicator ratings

Arrangement	1 Form A	1 Form B
Material	Gold-clad	
Rating(resistive load)	0.1 A 30 V DC	
Contact resistance	Max. 100 mΩ	

Note: Indicator type is only available for the 150 A type.

TYPICAL APPLICATIONS

- UPS (uninterruptible power supplies)
- Solar power generation systems
- Unmanned transport carts
- Battery inspection and testing equipment
- Welding equipment

ORDERING INFORMATION

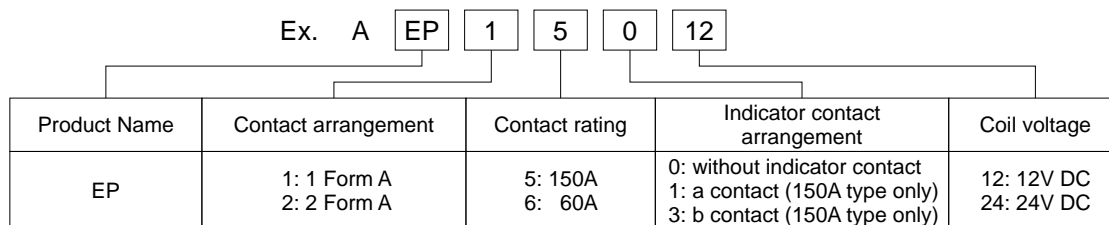

EP

TYPES AND COIL DATA (at 20°C 68°F)

Part No.	Coil voltage, V DC	Pick-up voltage, V DC (max.) (at 20°C)	Drop-out voltage, V DC (min.) (at 20°C)	Nominal coil current, mA (±10%) (at 20°C)	Operating power, W (12 V DC, at 20°C)	Max. allowable voltage, V DC
AEP25012*	12 V DC	9 V DC	1 V DC	2.8 A (at peak)*	35W(Inrush, approx. 0.1S) 5W(Stable)	16 V DC
AEP15012*				0.415 A	Max. 5W	
AEP16012						
AEP25024*	24 V DC	18 V DC	2 V DC	1.9 A (at peak)*	35W(Inrush, approx. 0.1S)	32 V DC
AEP15024*				2.2 A (at peak)*	Max. 5W (1 Form A) Max. 6W (2 Form A)	
AEP16024				0.208 A	Max. 5W	

Note: *Same coil data as Indicator type. When using a DC power supply use one that has a leeway of at least 150% current capacity.

Packing quantity

Types	Inner	Outer
150A 2 Form A	1pc.	5pcs.
150A 1 Form A	1pc.	10pcs.
60A 1 Form A	1pc.	20pcs.

SPARE PARTS

Installing parts	Part No.	Packing Quantity
M8 nut with washer for 150A type	AEV801	2pcs.
M5 screw for 60A type	AEV802	2pcs.
M4 screw for 30A type	AEV803	2pcs.
Bus bar for 60A type	AEV804	1pc.

DIMENSIONS

mm inch

150A 2 Form A

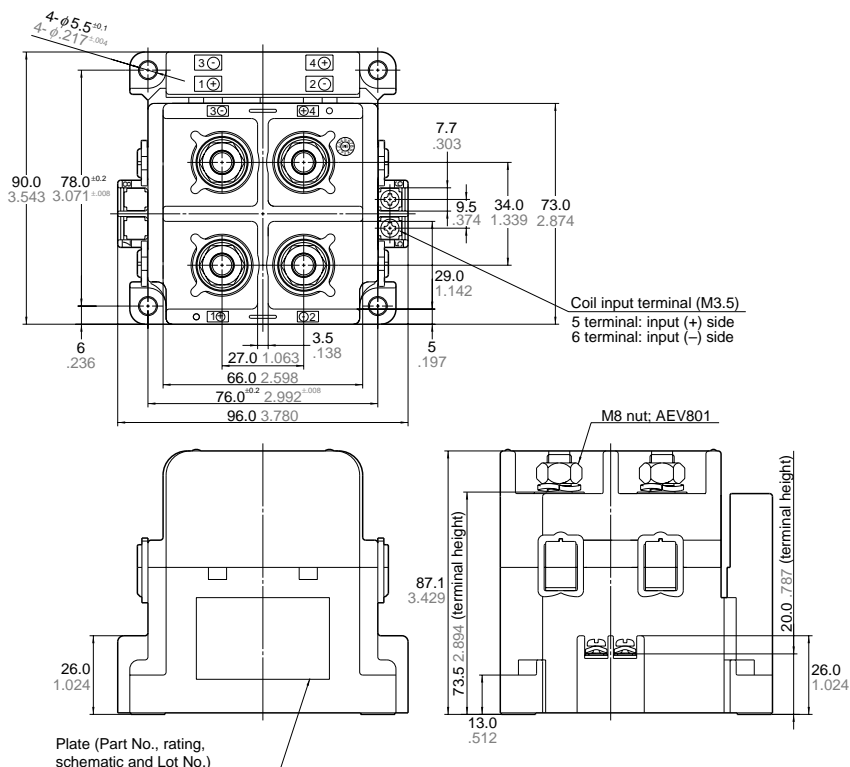

Schematic (TOP VIEW)

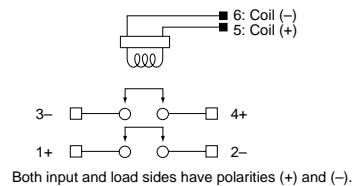

Mounting dimensions

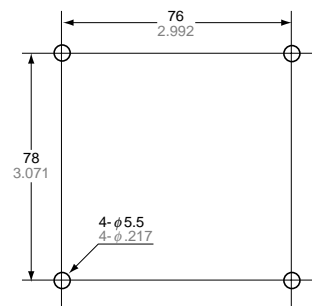

General tolerance:

less than 10 .394 ±0.3 ±0.012
 10 .394 to 50 1.969 ±0.6 ±0.024
 more than 50 1.969 ±1.0 ±0.039

150A 2 Form A (Indicator Type)

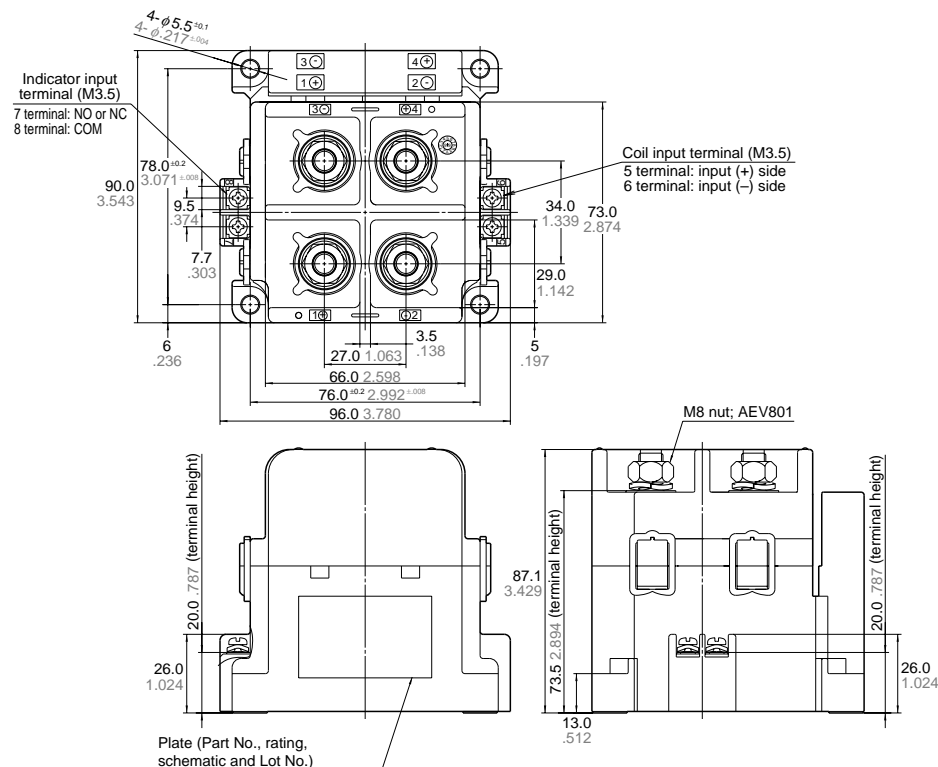

**Schematic (TOP VIEW)
1 Form A**

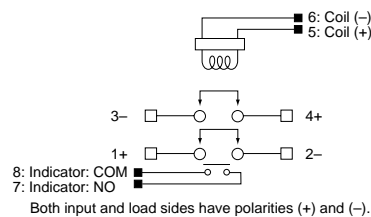

1 Form B

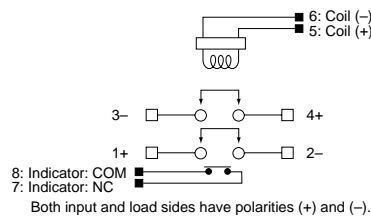

Mounting dimensions

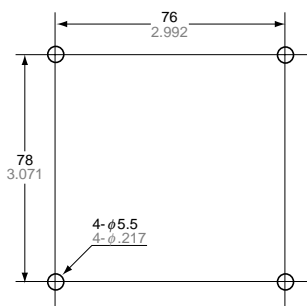

General tolerance:

less than 10 .394 ±0.3 ±0.012
10 .394 to 50 1.969 ±0.6 ±0.024
more than 50 1.969 ±1.0 ±0.039

150A 1 Form A

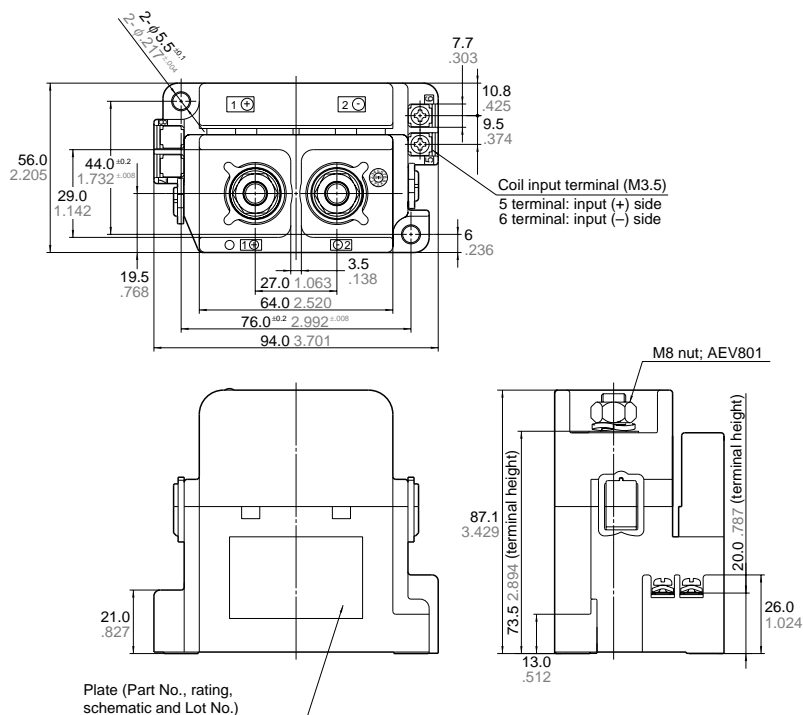

Schematic (TOP VIEW)

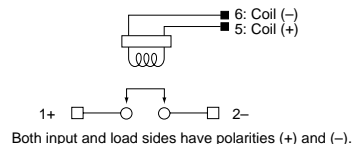

Mounting dimensions

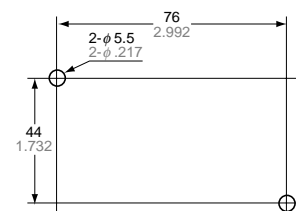

General tolerance:

less than 10 .394 ±0.3 ±0.012
10 .394 to 50 1.969 ±0.6 ±0.024
more than 50 1.969 ±1.0 ±0.039

150A 1 Form A (Indicator Type)

mm inch

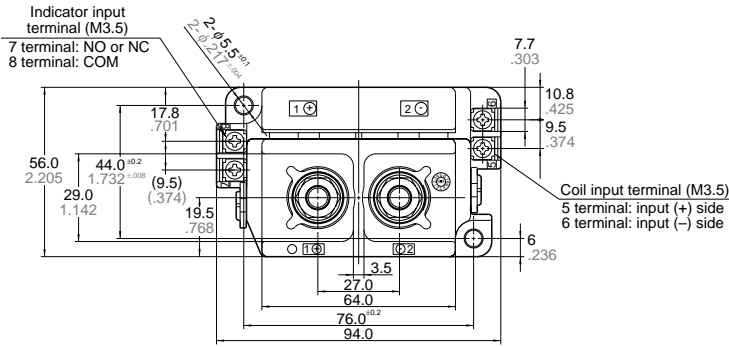

Schematic (TOP VIEW)
1 Form A type

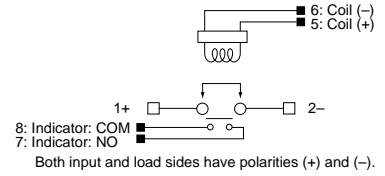

1 Form B type

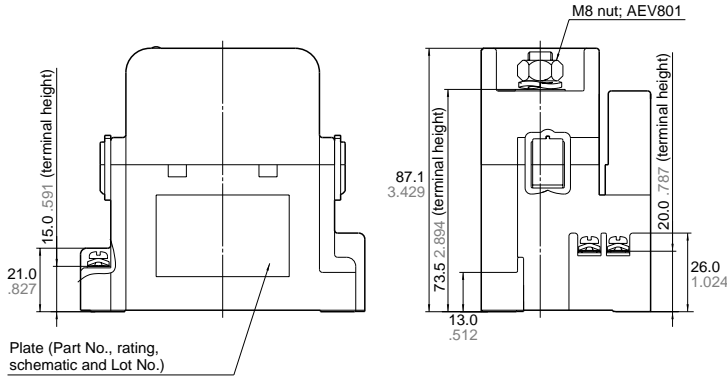
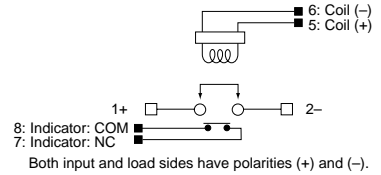

Mounting dimensions

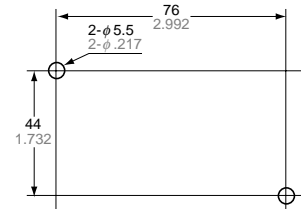

General tolerance:

less than 10 .394 ±0.3 ±0.12
10 .394 to 50 1.969 ±0.6 ±0.24
more than 50 1.969 ±1.0 ±0.39

60A

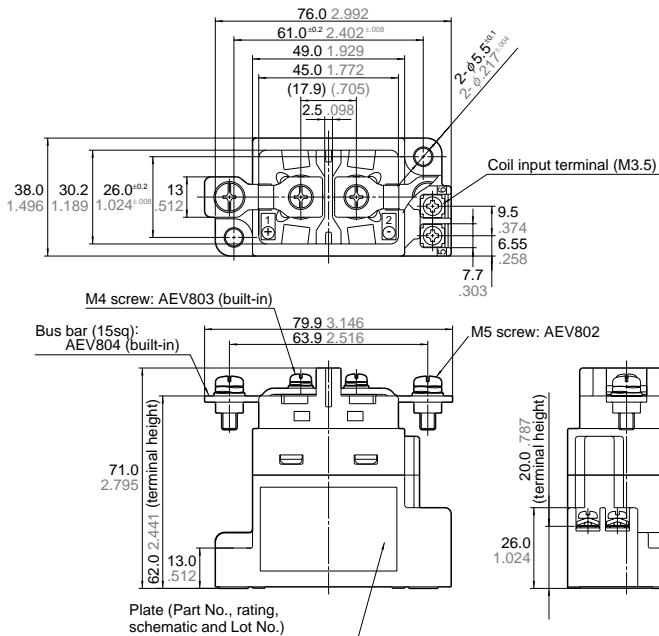

Schematic (TOP VIEW)

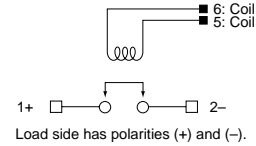

Mounting dimension

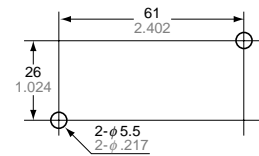

General tolerance:

less than 10 .394 ±0.3 ±0.12
10 .394 to 50 1.969 ±0.6 ±0.24
more than 50 1.969 ±1.0 ±0.39

REFERENCE DATA

1-(1) Ambient temperature characteristics (150 A type)

Sample: AEP15012, 3pcs

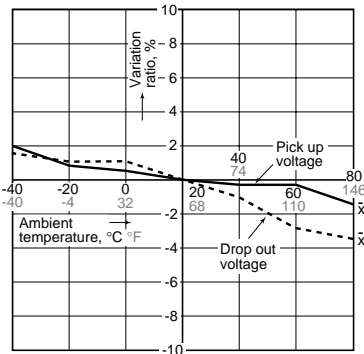

1-(2) Ambient temperature characteristics (Sample: AEP16012, 3pcs)

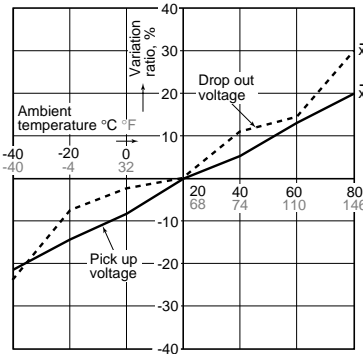

2. Max. switching capacity

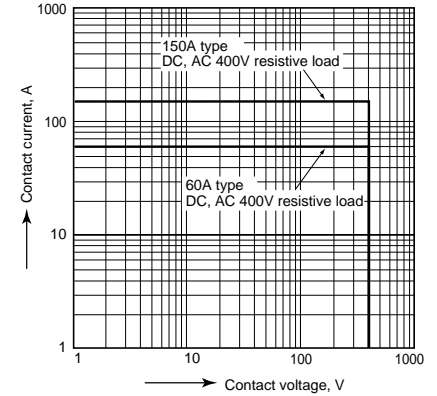

3. Switching life curve

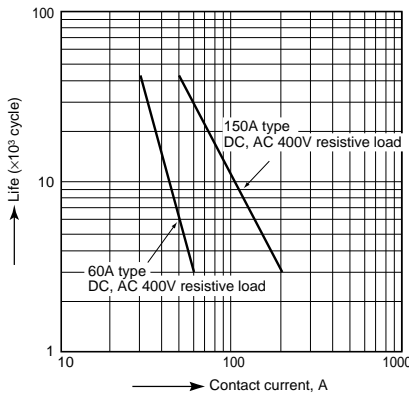

4. Cut-off life curve

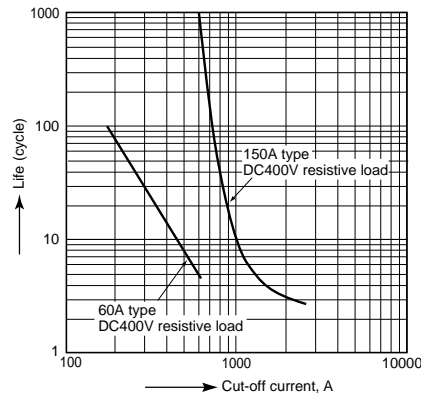

5. Carrying performance curve

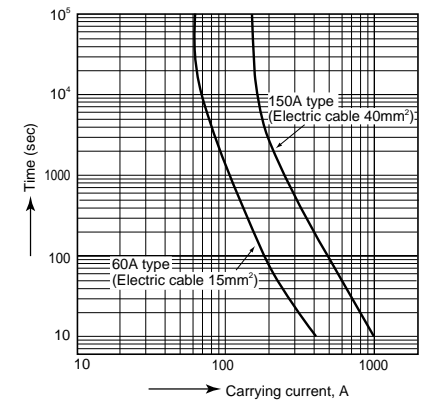

NOTES

1. When installing the relay, always use washers to prevent loosening of the screws.

Tighten each of the screws within the rated ranges given below. Exceeding the maximum torque may result in breakage. Mounting is possible in either direction.

- M8 screw (150 A main terminal): 8 to 10 N·m
- M5 screw (150 A, 60 A main unit mounting section): 2.5N·m to 3.6N·m
- M4 screw (60 A main terminal): 1.8 to 2.7 N·m
- M3.5 screw (Input terminal): 0.84 to 1.2 N·m

2. The coils (150 A type) and contacts (60 A, 150 A) of the relay are polarized, so follow the instructions in the connection schematic when connecting the coils and contacts.

Type 150 A has contains a reverse surge voltage absorption circuit; therefore a surge protector is not needed. We recommend installing a surge protector varistor (ZNR) for the 60 A types. Avoid using a diode as this may result in decreased cut-off capability.

3. As a general rule, do not use a relay if it has been dropped.

4. Avoid mounting the relay in strong magnetic fields (near a transformer or magnet) or close to an object that radiates heat.

5. Electrical life

This relay is a high-voltage direct-current switch. In its final breakdown mode, it may lose the ability to provide the proper cut-off. Therefore, do not exceed the indicated switching capacity and life. (Please treat the relay as a product with limited life and replace it when necessary.)

In the event that the relay loses cut-off ability, there is a possibility that burning may spread to surrounding parts, so configure the layout so that the power is turned off within one second.

6. Permeation life of internal gas

This relay uses a hermetically encased contact (capsule contact) with gas inside. The gas has a permeation life that is affected by the temperature inside the capsule contact (ambient temperature + temperature rise due to flow of electrical current). For this reason, make sure the ambient operating temperature is between -40 and 80°C -40 and $+176^{\circ}\text{F}$, and the ambient storage temperature is between -40 and 85°C -40 and $+185^{\circ}\text{F}$.

7. The case is designed so that it will not come off with normal handling.

If you remove the case, the relay will not function as intended, and its performance cannot be guaranteed.

8. If the power is turned off and then immediately on after applying the rated voltage (current) continuously to the relay's coil and contact, the resistance of the coil will increase due to a rise in the coil temperature. This causes the pick-up voltage to rise, and possibly exceed the rated pick-up voltage. In these circumstances, take measures such as reducing the load current, limiting the duration of current flow, and applying a coil voltage higher than the rated operating voltage (quick start).

9. The coil must only be supplied with its rated voltage. The voltage waveform supplied to the coil should be rectangular.

10. Take steps to ensure that voltages that exceed the maximum allowed voltage for a coil are never continuously applied.

11. Take steps to ensure that the rated voltage and current values for the contacts are never exceeded.

12. The rated control capacity and life are given as guides.

The contact life is heavily influenced by the type of load and other related conditions, and these factors must be given due consideration when using the relay.

13. Main contact ratings in the ratings apply to when there is a resistive load.

14. If you are using an inductive load (L load) such that $L/R > 1$ ms, add surge protection in parallel with the inductive load. If this is not done, the electrical life will decrease and cut-off failure may occur.

15. When using the 150 A type, mount it as far away as possible from amateur wireless transmitters or devices that may generate large surges. To prevent malfunctioning due to high emission levels, it may be necessary to take measures for E.M.I., such as adding a line noise filter or an electromagnetic shield.

16. Since coil current control is performed, a slight amount of superimposed line noise may be generated in the input line system. If this noise must be removed, install a line noise filter.

17. Be careful that foreign matter and oils do not stick to the main terminal part. It is likely to cause a terminal part to give off unusual heat. Use the following specifications for the harness bus bar that the relay connects to:

- 150A type: nominal cross sectional area: min. 38mm².
- 60A type: nominal cross sectional area: min. 14mm².

18. Avoid excessive load applied to the terminal in case of installing such as a bus bar etc., because it might give bad influence to the opening and closing performance.

- M8 screw terminal (150A main terminal part)

Terminal pulling up strength ; Max.100N per terminal

The up-down rotation torque applied to the terminal ; Max.15N·m

19. For AC cut-off there is no contact polarity, but confirm the electrical life using the actual load. In the case of DC cut-off the contacts have polarity, so take due care.