

**Hi-REL INFRARED
EMITTING DIODES
FOR
SPACE AND MILITARY
APPLICATIONS**

HEL-REL INFRARED EMITTING DIODES

The recommended testing program for all hi-rel IRLEDs follows the general requirements of Mil-S-19500. The customer may specify the testing program outlined below, or supply us with a detailed specification. When specifying our program, indicate if screening alone or screening with a combination of Group A, B and C inspections is required.

SCREENING REQUIREMENTS

STEPS	SCREEN	MIL-STD-750		
		METHOD	CONDITIONS	LTPD
1	Internal visual (precap) inspection	–	Per our specification	100%
2	High temp life (stabilization bake)	1032	T_A = max storage temp t = 24 hours minimum	100%
3	Thermal shock (temp cycling)	1051	Min to max storage temp, 20 cycles, 10 minute dwell at each extreme	100%
4	Constant acceleration	2006	Y1 dir., 20,000 Gs min	100%
5	Fine leak test	1071H	Per specification	100%
6	Gross leak test	1071C or E	Per specification	100%
7	Interim electrical measurements	–	Read & record P_0	100%
8	Power burn-in	1038	I_F = max current T_C = 25°C (or T_A as applicable) t = 96 hours minimum	100%
9	End point measurements	–	Read & record P_0 read V_F & V_R	100%
10	Delta endpoint of P_0	–	P_0 = +30% / –15%	100%

GROUP A INSPECTION

STEPS	TEST	MIL-STD-750		
		METHOD	CONDITIONS	LTPD
1	<u>Subgroup 1</u>			15
	Visual and mechanical inspection	2071	Per mechanical drawing, I.D. damage, lens cracks, etc.	
2	<u>Subgroup 2</u>			5
	Radiant power output	–	T_A = 25°C, I_F per spec	
	Forward voltage	4011	T_A = 25°C, I_F per spec	
4	Reverse breakdown	4016	T_A = 25°C, I_R per spec	

HEL-REL INFRARED EMITTING DIODES

GROUP B INSPECTION

STEPS	TEST	MIL-STD-750		
		METHOD	CONDITIONS	LTPD
1	Subgroup 1			15
	Solderability	2026		
2	Subgroup 2			10
	Thermal shock	1051	Min to max storage temp, 25 cycles, 10 minute dwell at each extreme	
	Fine leak test	1071H	Per specification	
	Gross leak test	1071 C or E		
	End point measurements	-	Read & record P ₀ , V _F , V _R	
6	Subgroup 3			5
	Beginning point measurements	-	Read & record P ₀	
	Steady state life test	1038	I _F = max current T _C = 25°C (or T _A as applicable) t = 340 hours minimum	
	End point measurements	-	Read & record P ₀ , V _F , V _R	
9	Delta endpoint of P ₀	-	P ₀ = +30%/-15%	
10	Subgroup 4**			20
	Decap internal visual	2075	1 device/0 failures	
11	Bond strength	2037	As specified, 0 failures allowed	
12	Subgroup 6			7
	Beginning point measurements	-	Read & record P ₀	
	High temp life (non-operating)	1032	T _A = max storage temp t = 340 hours minimum	
14	End point measurements	-	Read & record P ₀ , V _F , V _R	

GROUP C INSPECTION

STEPS	TEST	MIL-STD-750		
		METHOD	CONDITIONS	LTPD
1	Subgroup 1			15
	Physical dimensions	2026	Per Mechanical drawing	
2	Subgroup 2			10
	Thermal shock (glass strain)	1056A		
	Fine leak test	1071H	Per specification	
	Gross leak test	1071 C or E		
	Moisture resistance	1021	Omit initial conditioning	
	External visual	1071	I.D. damage, lens cracks, etc.	
	End point measurements	-	Read & record P ₀ , V _F , V _R	
8	Subgroup 3			10
	Shock	2016	Non-operating, 1500 Gs, 0.5ms, 5 blows ea. dir.	
	Vibration, variable frequency	2056		
	Constant acceleration	2006	One minute each X1, Y1, and Z1 axes, 20K Gs min.	
11	End point measurements	-	Read & record P ₀ , V _F , V _R	
12	Subgroup 4**			15
	Salt atmosphere	1041		
13	Subgroup 6			10
	Beginning point measurements	-	Read & record P ₀	
	Steady state life test	1026	I _F = max current T _C = 25°C (or T _A as applicable) t = 1000 hours minimum	
	End point measurements	-	Read & record P ₀ , V _F , V _R	
16	Delta endpoint of P ₀	-	P ₀ = +30%/-15%	

**Except for pill packages

HI-REL RAD HARD IR EMITTERS

OD-800W

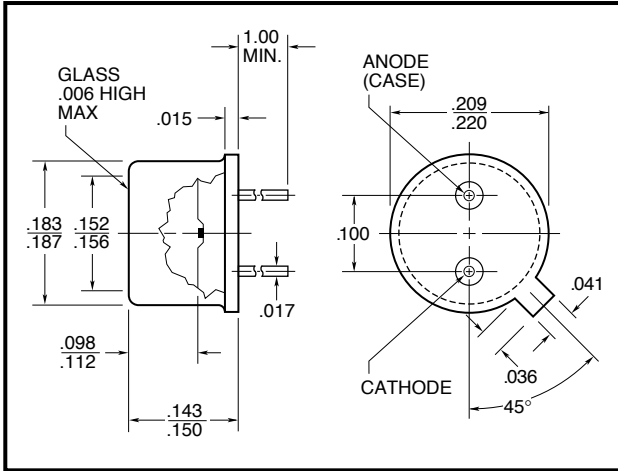

FEATURES

- Designed for high radiation tolerance
- Excellent power degradation characteristics
- High power output
- Fast response
- Hermetically sealed metal package
- MIL-S-19500 screening available
- No internal coatings

All surfaces are gold plated. Dimensions are nominal values in inches unless otherwise specified. Window caps are welded to the case.

ELECTRO-OPTICAL CHARACTERISTICS AT 25°C

PARAMETERS	TEST CONDITIONS	MIN	TYP	MAX	UNITS
Total Power Output, P_o	$I_F = 100\text{mA}$	2	3		mW
Peak Emission Wavelength, λ_p	$I_F = 50\text{mA}$		810		nm
Spectral Bandwidth at 50%, $\Delta\lambda$			50		nm
Half Intensity Beam Angle, θ				80	
Forward Voltage, V_F	$I_F = 100\text{mA}$		1.45	1.8	Volts
Reverse Breakdown Voltage, V_R	$I_R = 10\mu\text{A}$	3	4		Volts
Capacitance, C	$V_R = 0\text{V}$		150		pF
Rise Time			60		nsec
Fall Time			60		nsec

ABSOLUTE MAXIMUM RATINGS AT 25°C CASE

Power Dissipation ¹	180mW
Continuous Forward Current	100mA
Peak Forward Current (10 μs , 150Hz) ²	3A
Reverse Voltage	3V
Lead Soldering Temperature (1/16" from case for 10sec)	240°C

¹Derate per Thermal Derating Curve above 25°C

²Derate linearly above 25°C

THERMAL PARAMETERS

Storage and Operating Temperature Range	-65°C TO 150°C
Maximum Junction Temperature	150°C
Thermal Resistance, R_{THJA} ¹	400°C/W Typical
Thermal Resistance, R_{THJA} ²	135°C/W Typical

¹Heat transfer minimized by measuring in still air with minimum heat conducting through leads

²Air circulating at a rapid rate to keep case temperature at 25°C

HI-REL RAD HARD IR EMITTERS

OD-800W

MAXIMUM RATINGS

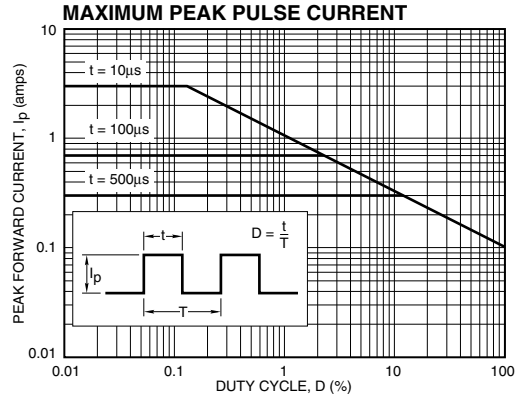
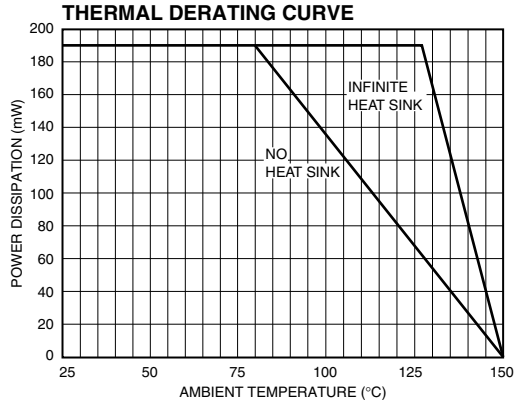

TYPICAL CHARACTERISTICS

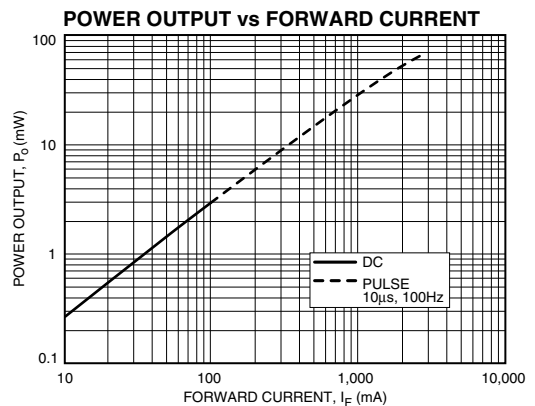
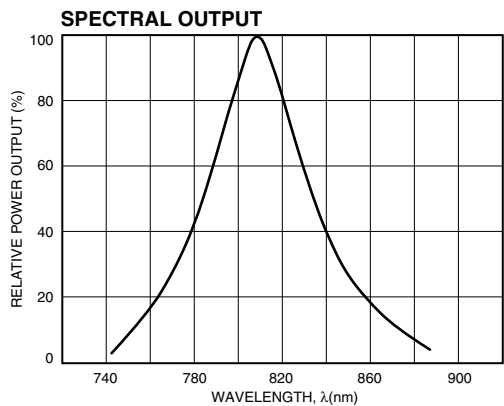
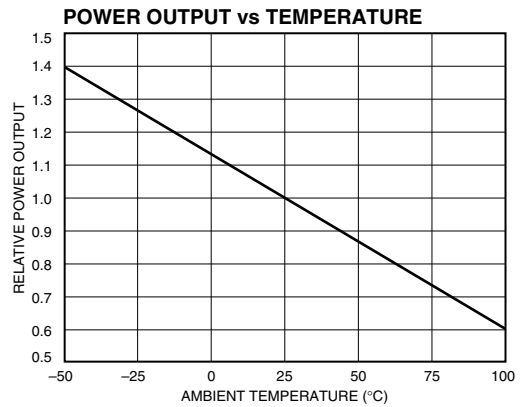
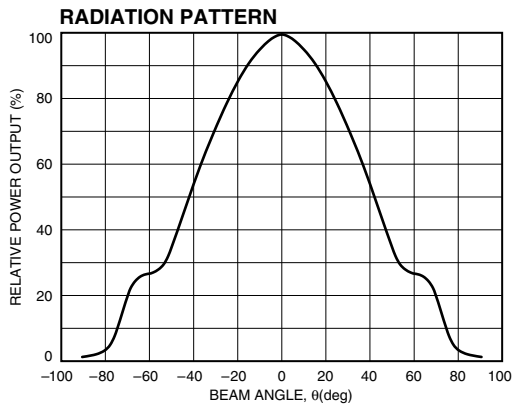
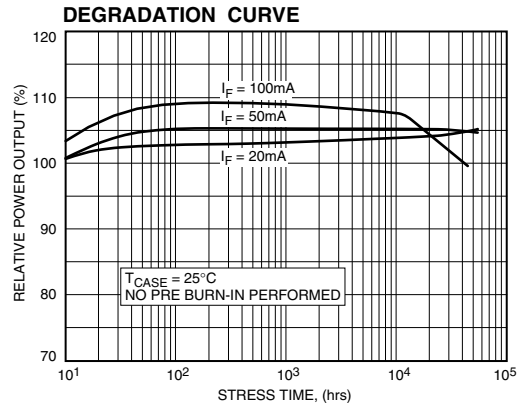
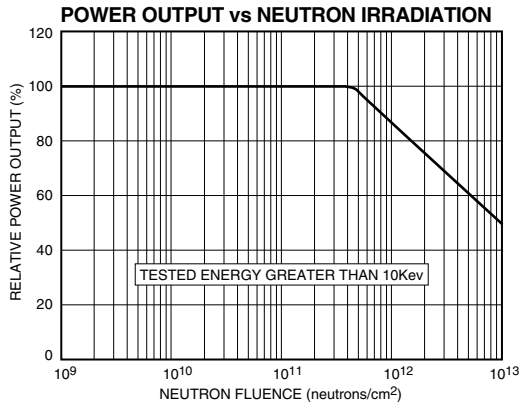

HI-REL RAD HARD IR EMITTERS

OD-800L

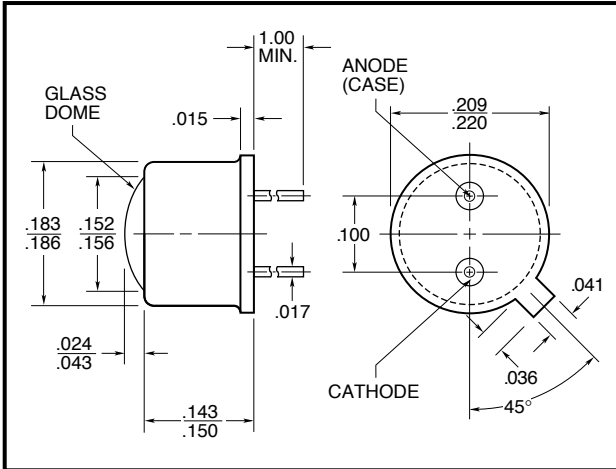

FEATURES

- Designed for high radiation tolerance
- Excellent power degradation characteristics
- High power output
- Fast response
- Hermetically sealed metal package
- MIL-S-19500 screening available
- No internal coatings

All surfaces are gold plated. Dimensions are nominal values in inches unless otherwise specified. Window caps are welded to the case.

ELECTRO-OPTICAL CHARACTERISTICS AT 25°C

PARAMETERS	TEST CONDITIONS	MIN	TYP	MAX	UNITS
Total Power Output, P_o	$I_F = 100\text{mA}$	2	3		mW
Peak Emission Wavelength, λ_p	$I_F = 50\text{mA}$		810		nm
Spectral Bandwidth at 50%, $\Delta\lambda$			50		nm
Half Intensity Beam Angle, θ				35	
Forward Voltage, V_F	$I_F = 100\text{mA}$		1.45	1.8	Volts
Reverse Breakdown Voltage, V_R	$I_R = 10\mu\text{A}$	3	4		Volts
Capacitance, C	$V_R = 0\text{V}$		150		pF
Rise Time			60		nsec
Fall Time			60		nsec

ABSOLUTE MAXIMUM RATINGS AT 25°C CASE

Power Dissipation ¹	180mW
Continuous Forward Current	100mA
Peak Forward Current (10 μs , 150Hz) ²	3A
Reverse Voltage	3V
Lead Soldering Temperature (1/16" from case for 10sec)	240°C

¹Derate per Thermal Derating Curve above 25°C

²Derate linearly above 25°C

THERMAL PARAMETERS

Storage and Operating Temperature Range	-65°C TO 150°C
Maximum Junction Temperature	150°C
Thermal Resistance, R_{THJA} ¹	400°C/W Typical
Thermal Resistance, R_{THJA} ²	135°C/W Typical

¹Heat transfer minimized by measuring in still air with minimum heat conducting through leads

²Air circulating at a rapid rate to keep case temperature at 25°C

HI-REL RAD HARD IR EMITTERS

OD-800L

MAXIMUM RATINGS

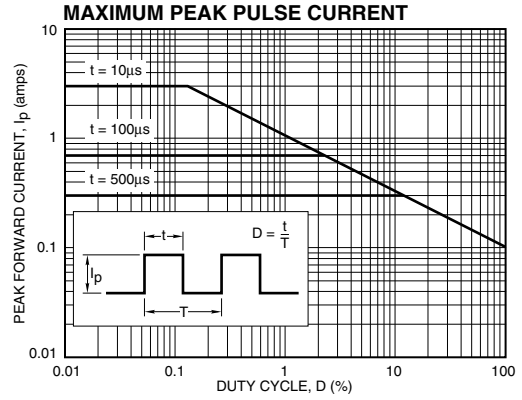
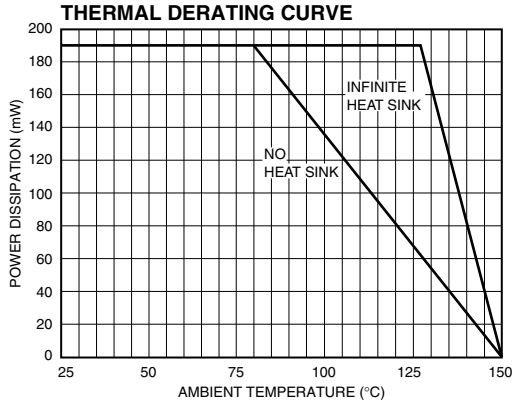

TYPICAL CHARACTERISTICS

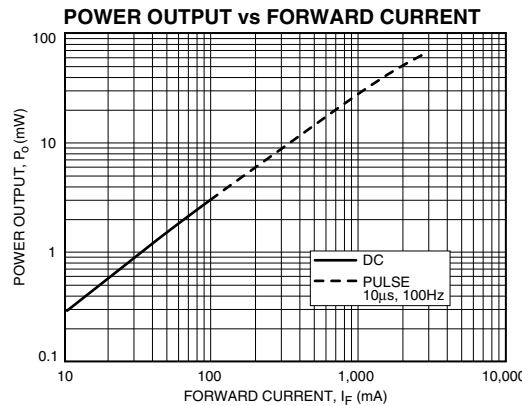
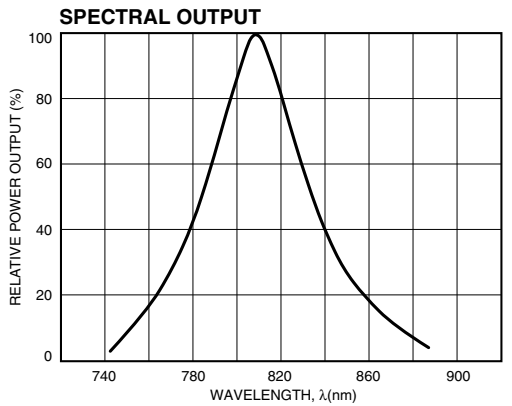
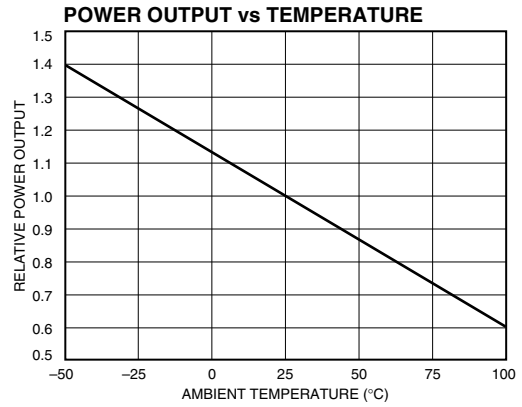
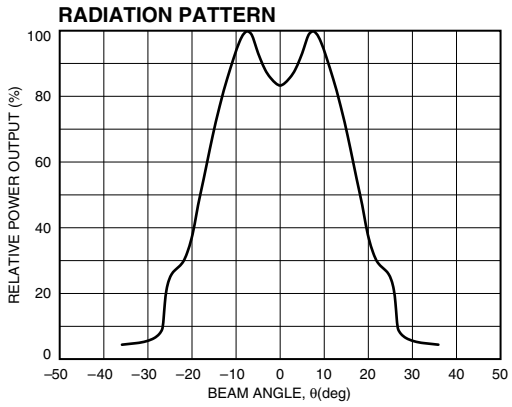
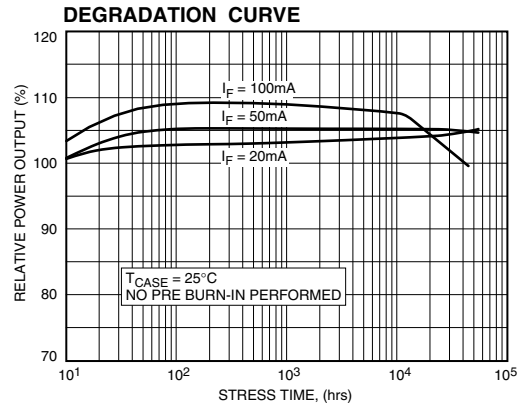
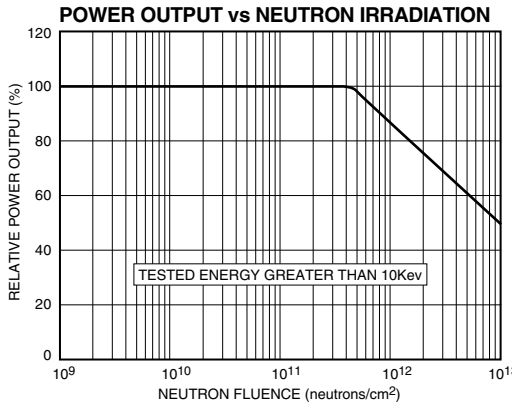

HI-REL RAD HARD IR EMITTERS

OD-800L

MAXIMUM RATINGS

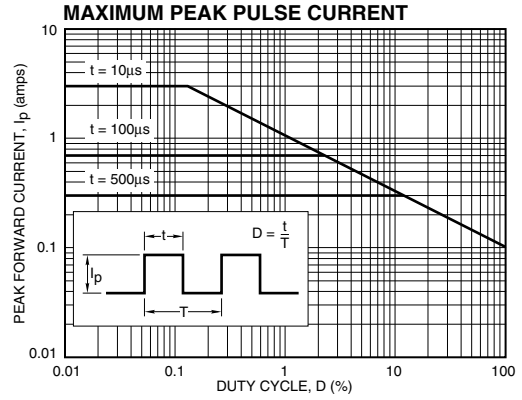
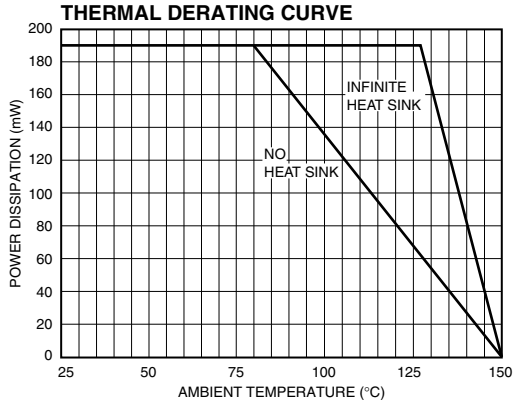

TYPICAL CHARACTERISTICS

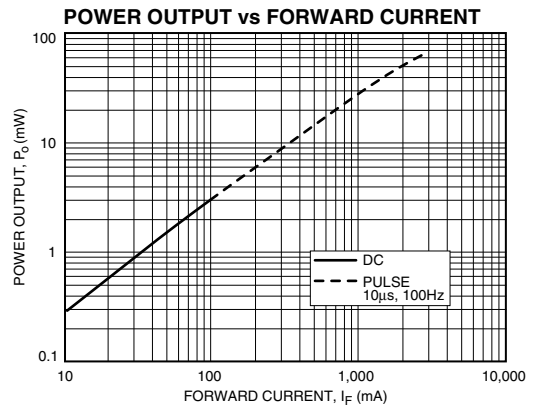
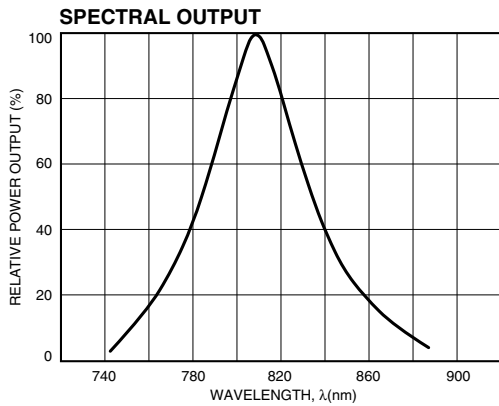
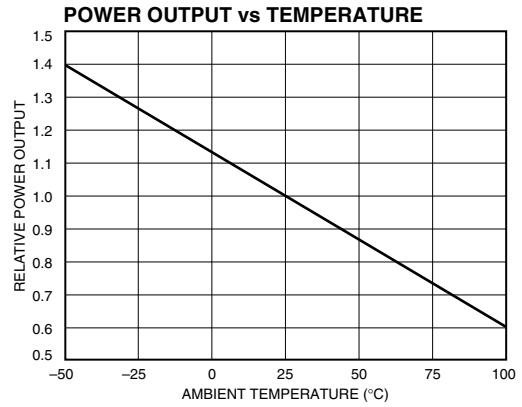
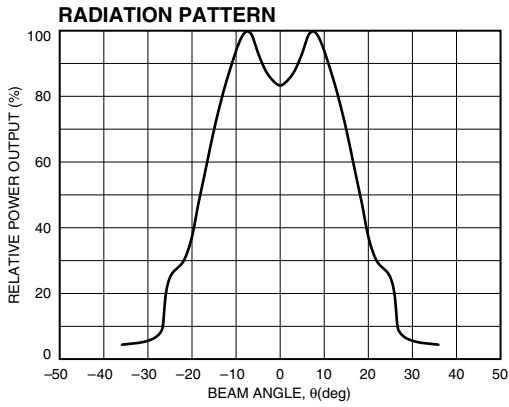
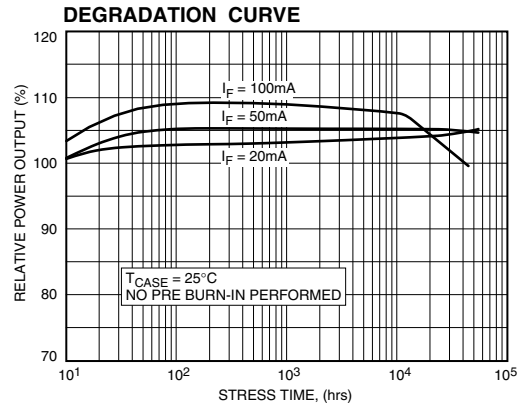
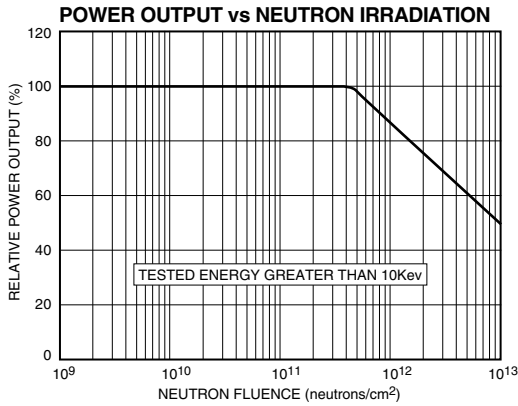

HI-REL RAD HARD IR EMITTERS

OD-800F

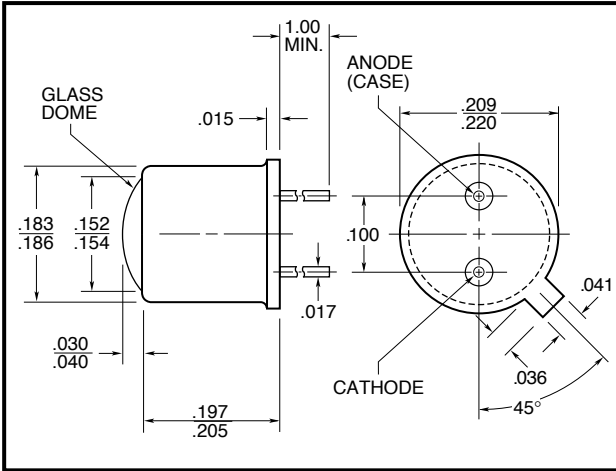

FEATURES

- Designed for high radiation tolerance
- Excellent power degradation characteristics
- High power output
- Fast response
- Hermetically sealed metal package
- MIL-S-19500 screening available
- No internal coatings

All surfaces are gold plated. Dimensions are nominal values in inches unless otherwise specified. Window caps are welded to the case.

ELECTRO-OPTICAL CHARACTERISTICS AT 25°C

PARAMETERS	TEST CONDITIONS	MIN	TYP	MAX	UNITS
Total Power Output, P_o	$I_F = 100\text{mA}$	1.5	3		mW
Peak Emission Wavelength, λ_p	$I_F = 50\text{mA}$		810		nm
Spectral Bandwidth at 50%, $\Delta\lambda$			50		nm
Half Intensity Beam Angle, θ			8		Deg
Forward Voltage, V_F	$I_F = 100\text{mA}$		1.45	1.8	Volts
Reverse Breakdown Voltage, V_R	$I_R = 10\mu\text{A}$	3	4		Volts
Capacitance, C	$V_R = 0\text{V}$		150		pF
Rise Time			60		nsec
Fall Time			60		nsec

ABSOLUTE MAXIMUM RATINGS AT 25°C CASE

Power Dissipation ¹	180mW
Continuous Forward Current	100mA
Peak Forward Current (10 μs , 150Hz) ²	3A
Reverse Voltage	3V
Lead Soldering Temperature (1/16" from case for 10sec)	240°C

¹Derate per Thermal Derating Curve above 25°C

²Derate linearly above 25°C

THERMAL PARAMETERS

Storage and Operating Temperature Range	-65°C TO 150°C
Maximum Junction Temperature	150°C
Thermal Resistance, R_{THJA} ¹	400°C/W Typical
Thermal Resistance, R_{THJA} ²	135°C/W Typical

¹Heat transfer minimized by measuring in still air with minimum heat conducting through leads

²Air circulating at a rapid rate to keep case temperature at 25°C

HI-REL RAD HARD IR EMITTERS

OD-800F

MAXIMUM RATINGS

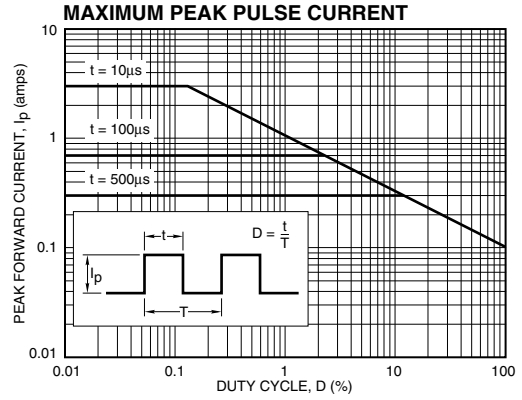
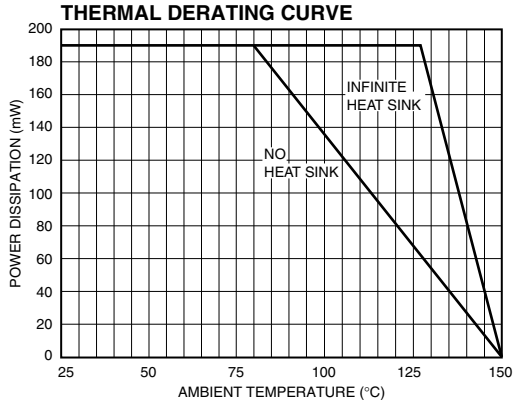

TYPICAL CHARACTERISTICS

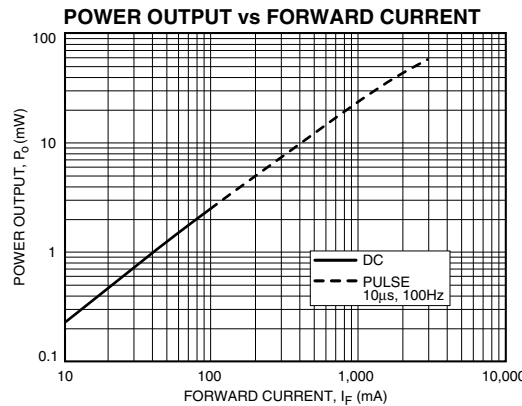
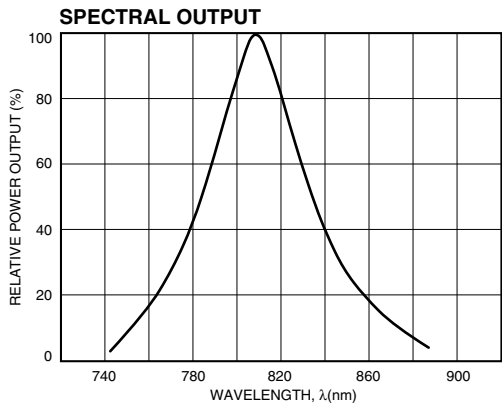
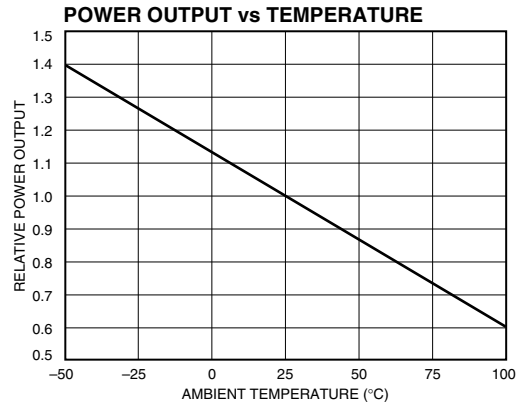
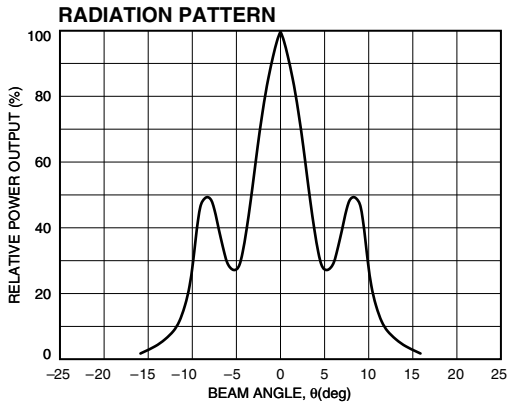
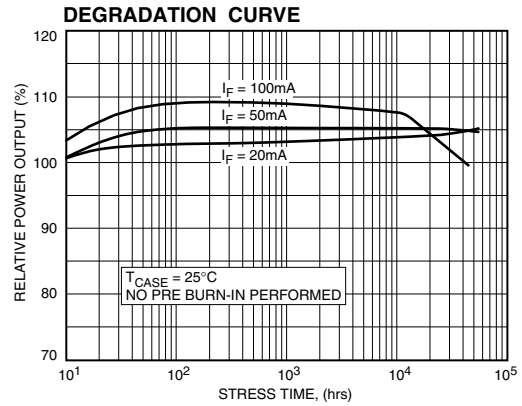
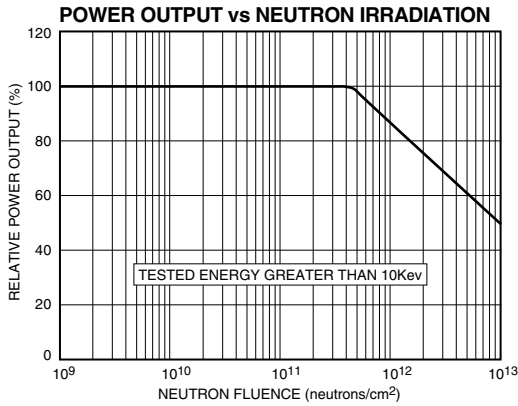

HI-REL RAD HARD IR EMITTERS

OD-800PP

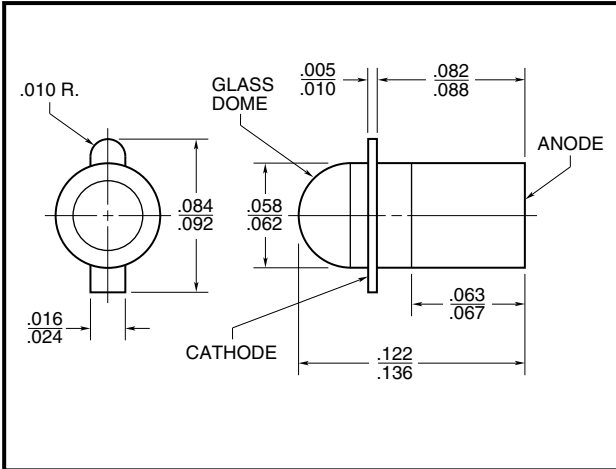

FEATURES

- Designed for high radiation tolerance
- Super high reliability
- High power output
- Fast response
- Hermetically sealed miniature pill package
- MIL-S-19500 screening available
- No internal coatings

All surfaces are gold plated. Dimensions are nominal values in inches unless otherwise specified.

ELECTRO-OPTICAL CHARACTERISTICS AT 25°C

PARAMETERS	TEST CONDITIONS	MIN	TYP	MAX	UNITS
Total Power Output, P_O	$I_F = 50\text{mA}$	0.5	0.8		mW
Peak Emission Wavelength, λ_P	$I_F = 50\text{mA}$		810		nm
Spectral Bandwidth at 50%, $\Delta\lambda$			50		nm
Half Intensity Beam Angle, θ			25		Deg
Forward Voltage, V_F	$I_F = 50\text{mA}$		1.4	1.6	Volts
Reverse Breakdown Voltage, V_R	$I_R = 10\mu\text{A}$	3	4		Volts
Capacitance, C	$V_R = 0\text{V}$		150		pF
Rise Time			60		nsec
Fall Time			60		nsec

ABSOLUTE MAXIMUM RATINGS AT 25°C CASE

Power Dissipation ¹	180mW
Continuous Forward Current	100mA
Peak Forward Current (10 μs , 150Hz) ²	3A
Reverse Voltage	3V
Lead Soldering Temperature	240°C
Storage and Operating Temperature Range	-55°C to 125°C

¹Derate per Thermal Derating Curve above 25°C

²Derate linearly above 25°C

HI-REL RAD HARD IR EMITTERS

OD-800PP

MAXIMUM RATINGS

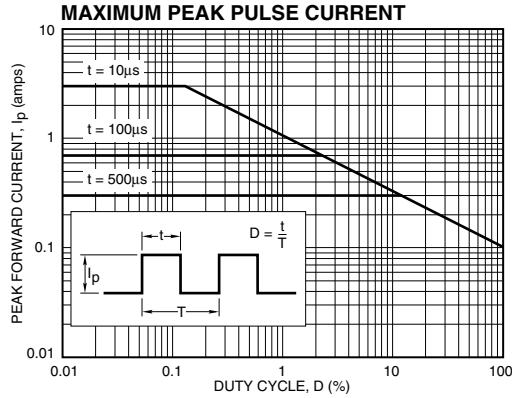

TYPICAL CHARACTERISTICS

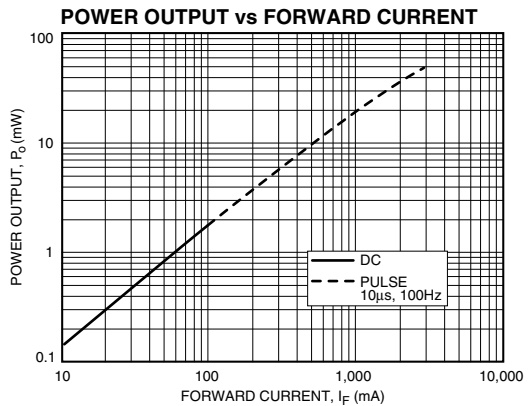
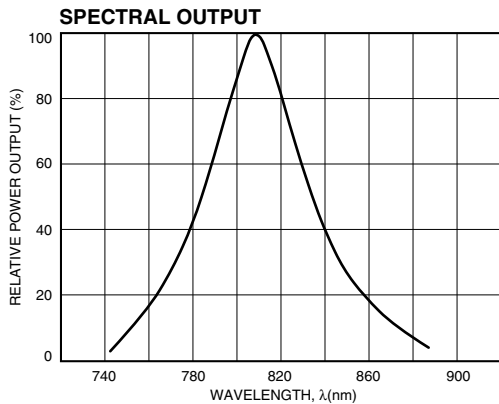
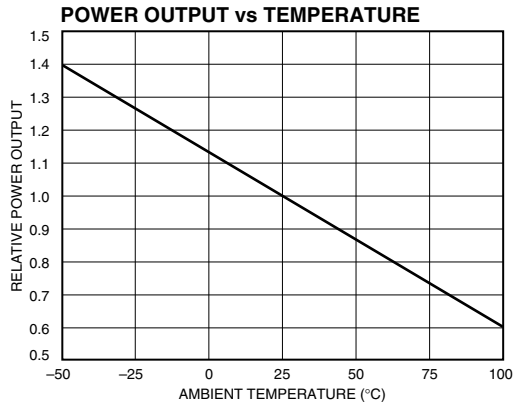
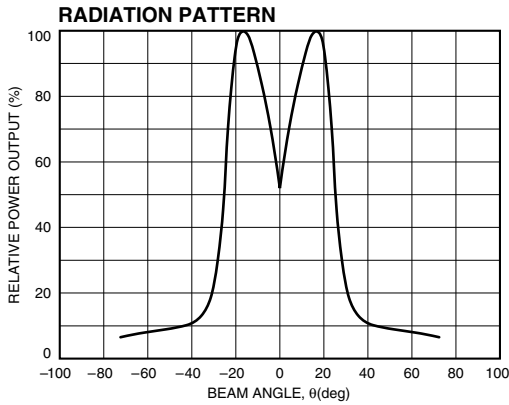
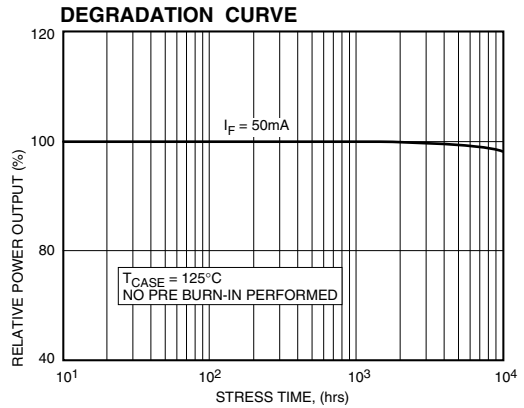
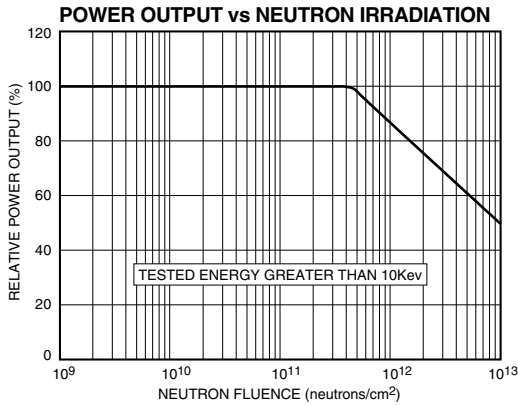

HI-REL GaAlAs IR EMITTERS

OD-880WJ

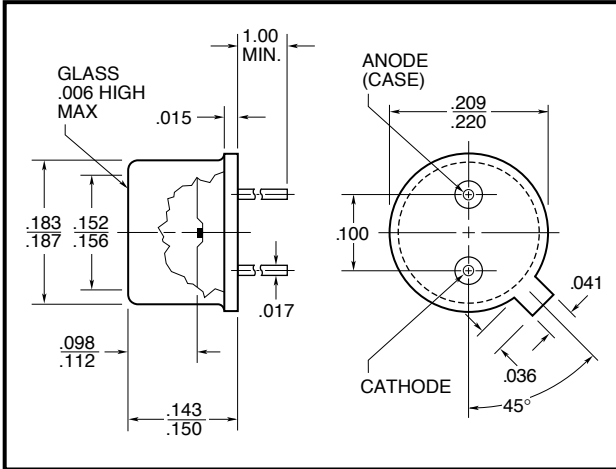

FEATURES

- High reliability LPE GaAlAs IRLEDs
- High power output
- 880nm peak emission
- Hermetically sealed TO-46 package
- MIL-S-19500 screening available
- No internal coatings

All surfaces are gold plated. Dimensions are nominal values in inches unless otherwise specified. Window caps are welded to the case.

ELECTRO-OPTICAL CHARACTERISTICS AT 25°C

PARAMETERS	TEST CONDITIONS	MIN	TYP	MAX	UNITS
Total Power Output, P_o	$I_F = 100\text{mA}$	7	9		mW
Peak Emission Wavelength, λ_p	$I_F = 50\text{mA}$		880		nm
Spectral Bandwidth at 50%, $\Delta\lambda$			80		nm
Half Intensity Beam Angle, θ			80		Deg
Forward Voltage, V_F	$I_F = 100\text{mA}$		1.55	1.9	Volts
Reverse Breakdown Voltage, V_R	$I_R = 10\mu\text{A}$	5	30		Volts
Capacitance, C	$V_R = 0\text{V}$		17		pF
Rise Time			0.5		μsec
Fall Time			0.5		μsec

ABSOLUTE MAXIMUM RATINGS AT 25°C CASE

Power Dissipation ¹	190mW
Continuous Forward Current	100mA
Peak Forward Current (10 μs , 400Hz) ²	3A
Reverse Voltage	5V
Lead Soldering Temperature (1/16" from case for 10sec)	240°C

¹Derate per Thermal Derating Curve above 25°C

²Derate linearly above 25°C

THERMAL PARAMETERS

Storage and Operating Temperature Range	-65°C TO 150°C
Maximum Junction Temperature	150°C
Thermal Resistance, R_{THJA} ¹	400°C/W Typical
Thermal Resistance, R_{THJA} ²	160°C/W Typical

¹Heat transfer minimized by measuring in still air with minimum heat conducting through leads

²Air circulating at a rapid rate to keep case temperature at 25°C

HI-REL GaAlAs IR EMITTERS

OD-880WJ

MAXIMUM RATINGS

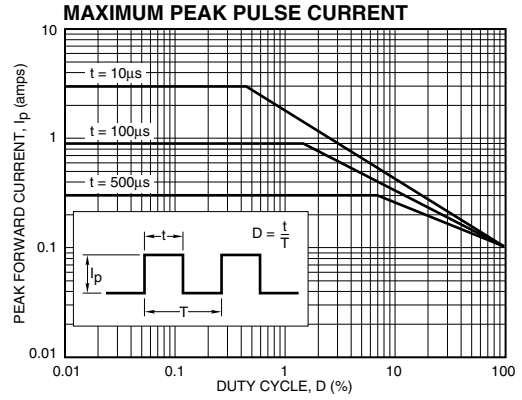
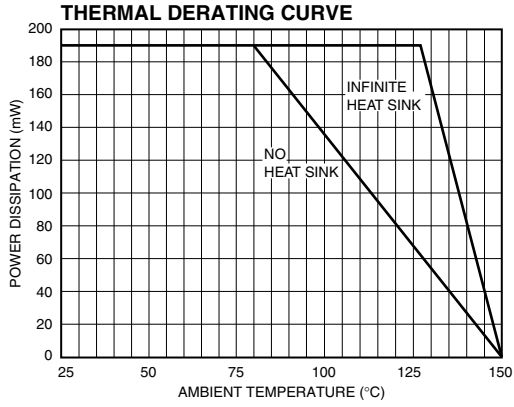

TYPICAL CHARACTERISTICS

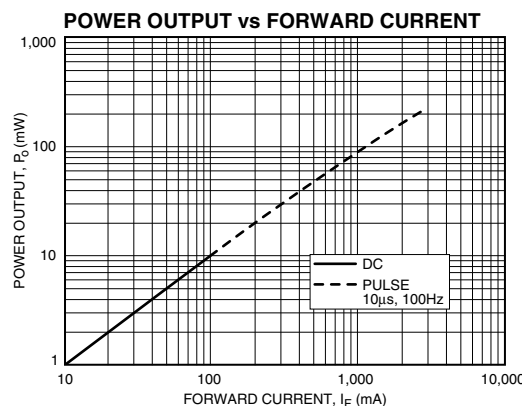
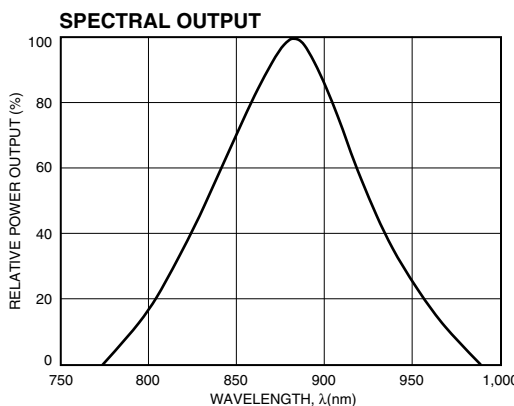
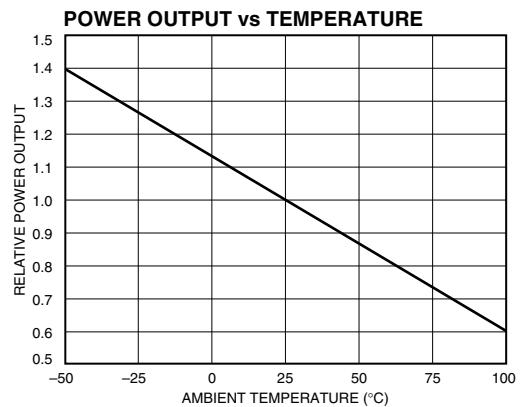
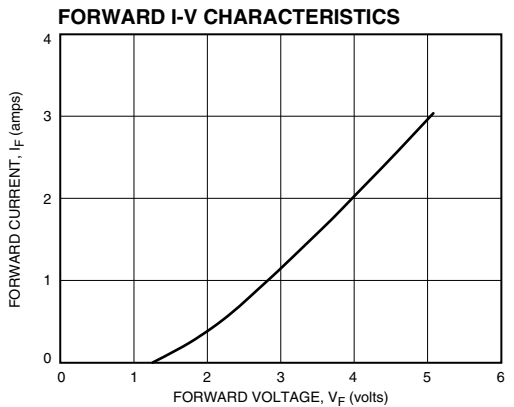
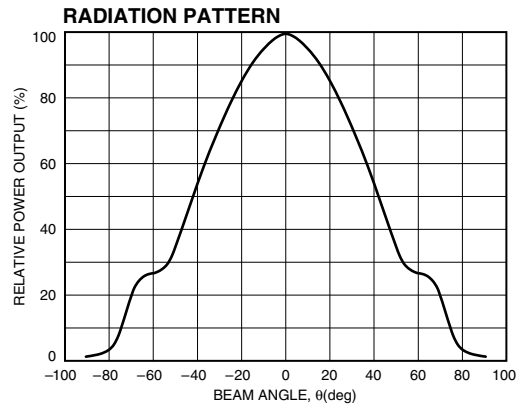
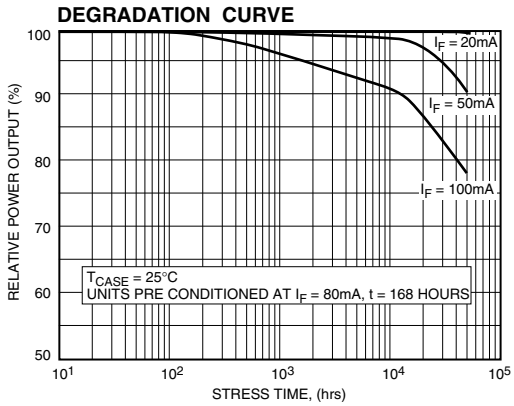

HI-REL GaAlAs IR EMITTERS

OD-880LJ

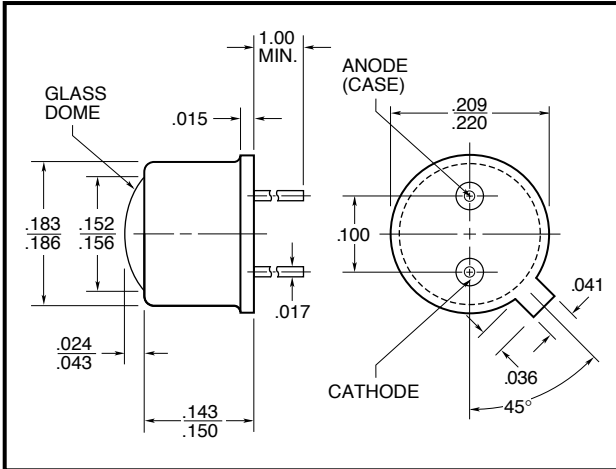

FEATURES

- High reliability LPE GaAlAs IRLEDs
- High power output
- 880nm peak emission
- Hermetically sealed TO-46 package
- MIL-S-19500 screening available
- No internal coatings

All surfaces are gold plated. Dimensions are nominal values in inches unless otherwise specified. Window caps are welded to the case.

ELECTRO-OPTICAL CHARACTERISTICS AT 25°C

PARAMETERS	TEST CONDITIONS	MIN	TYP	MAX	UNITS
Total Power Output, P_o	$I_F = 100\text{mA}$	6	8.5		mW
Peak Emission Wavelength, λ_p	$I_F = 50\text{mA}$		880		nm
Spectral Bandwidth at 50%, $\Delta\lambda$			80		nm
Half Intensity Beam Angle, θ				35	
Forward Voltage, V_F	$I_F = 100\text{mA}$		1.55	1.9	Volts
Reverse Breakdown Voltage, V_R	$I_R = 10\mu\text{A}$	5	30		Volts
Capacitance, C	$V_R = 0\text{V}$		17		pF
Rise Time			0.5		μsec
Fall Time			0.5		μsec

ABSOLUTE MAXIMUM RATINGS AT 25°C CASE

Power Dissipation ¹	190mW
Continuous Forward Current	100mA
Peak Forward Current (10 μs , 400Hz) ²	3A
Reverse Voltage	5V
Lead Soldering Temperature (1/16" from case for 10sec)	240°C

¹Derate per Thermal Derating Curve above 25°C

²Derate linearly above 25°C

THERMAL PARAMETERS

Storage and Operating Temperature Range	-65°C TO 150°C
Maximum Junction Temperature	150°C
Thermal Resistance, R_{THJA} ¹	370°C/W Typical
Thermal Resistance, R_{THJA} ²	120°C/W Typical

¹Heat transfer minimized by measuring in still air with minimum heat conducting through leads

²Air circulating at a rapid rate to keep case temperature at 25°C

HI-REL GaAlAs IR EMITTERS

OD-880LJ

MAXIMUM RATINGS

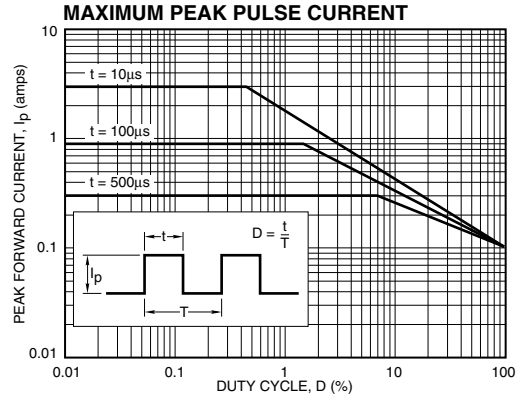
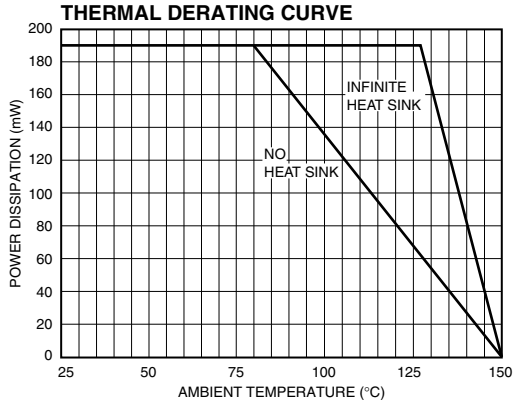

TYPICAL CHARACTERISTICS

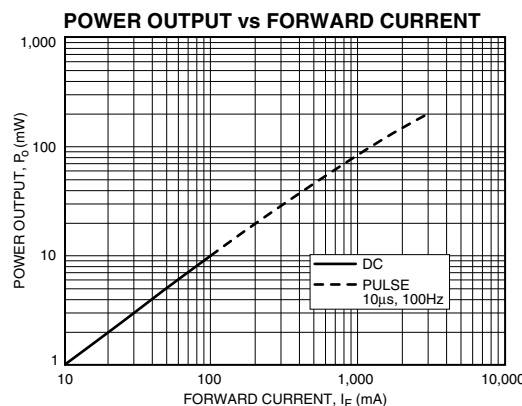
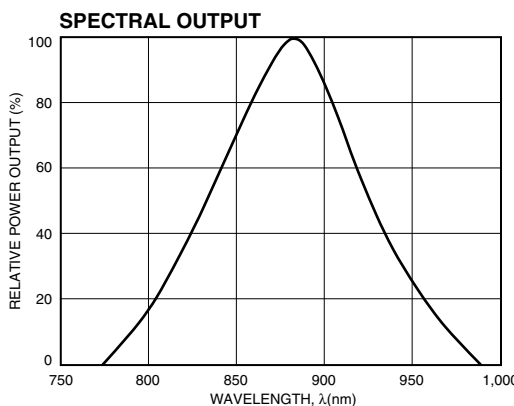
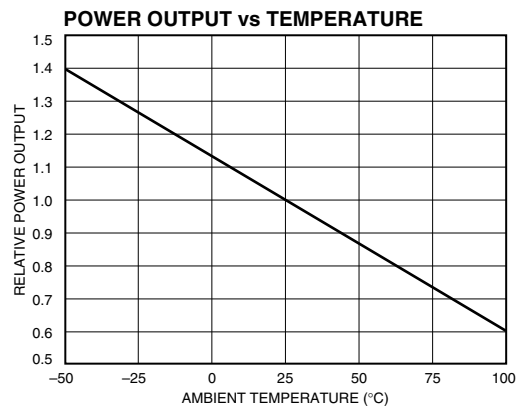
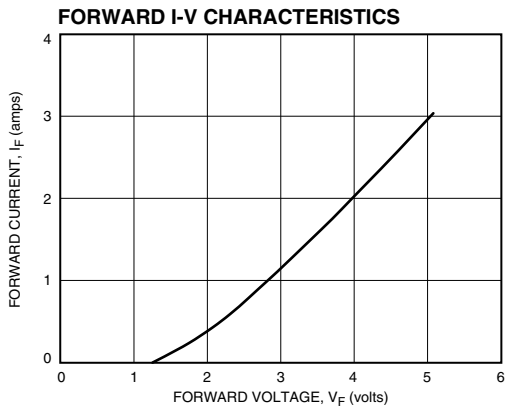
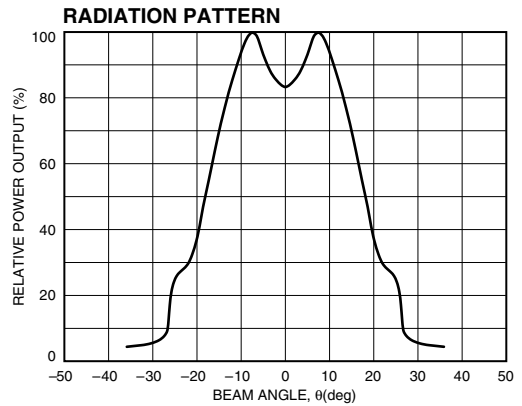
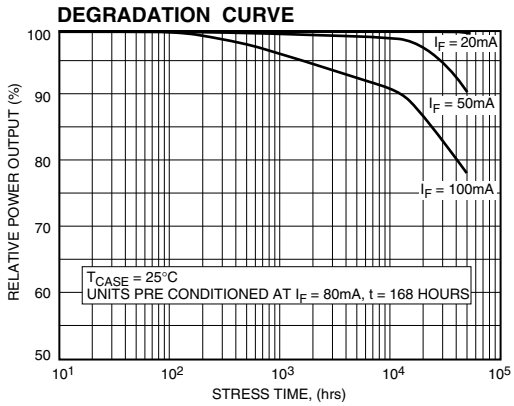

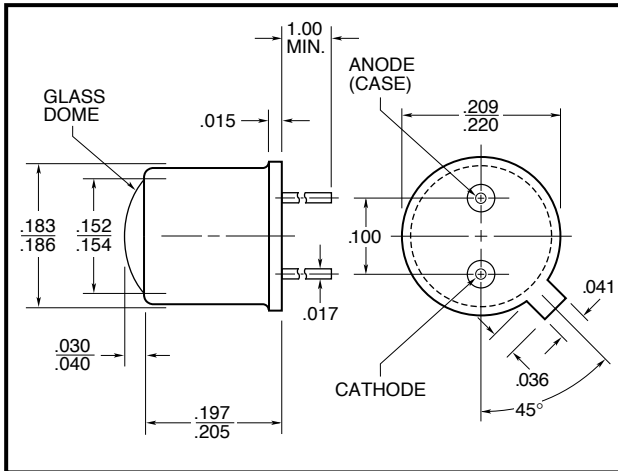
HI-REL GaAlAs IR EMITTERS**OD-880FJ****FEATURES**

- High reliability LPE GaAlAs IRLEDs
- High power output
- 880nm peak emission
- Hermetically sealed TO-46 package
- MIL-S-19500 screening available
- No internal coatings

All surfaces are gold plated. Dimensions are nominal values in inches unless otherwise specified. Window caps are welded to the case.

ELECTRO-OPTICAL CHARACTERISTICS AT 25°C

PARAMETERS	TEST CONDITIONS	MIN	TYP	MAX	UNITS
Total Power Output, P_o	$I_F = 100\text{mA}$	6	8		mW
Peak Emission Wavelength, λ_p	$I_F = 50\text{mA}$		880		nm
Spectral Bandwidth at 50%, $\Delta\lambda$			80		nm
Half Intensity Beam Angle, θ			8		Deg
Forward Voltage, V_F	$I_F = 100\text{mA}$		1.55	1.9	Volts
Reverse Breakdown Voltage, V_R	$I_R = 10\mu\text{A}$	5	30		Volts
Capacitance, C	$V_R = 0\text{V}$		17		pF
Rise Time			0.5		μsec
Fall Time			0.5		μsec

ABSOLUTE MAXIMUM RATINGS AT 25°C CASE

Power Dissipation ¹	190mW
Continuous Forward Current	100mA
Peak Forward Current (10 μs , 400Hz) ²	3A
Reverse Voltage	5V
Lead Soldering Temperature (1/16" from case for 10sec)	240°C

¹Derate per Thermal Derating Curve above 25°C

²Derate linearly above 25°C

THERMAL PARAMETERS

Storage and Operating Temperature Range	-65°C TO 150°C
Maximum Junction Temperature	150°C
Thermal Resistance, R_{THJA} ¹	370°C/W Typical
Thermal Resistance, R_{THJA} ²	120°C/W Typical

¹Heat transfer minimized by measuring in still air with minimum heat conducting through leads

²Air circulating at a rapid rate to keep case temperature at 25°C

HI-REL GaAlAs IR EMITTERS

OD-880FJ

MAXIMUM RATINGS

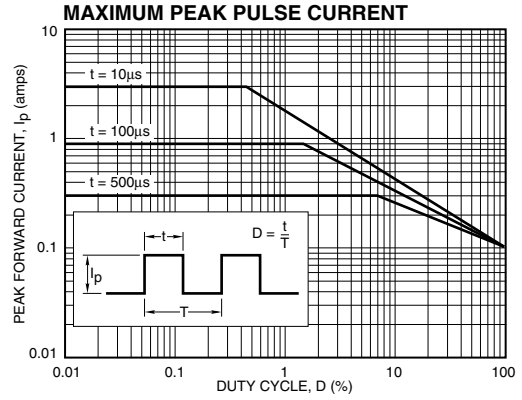
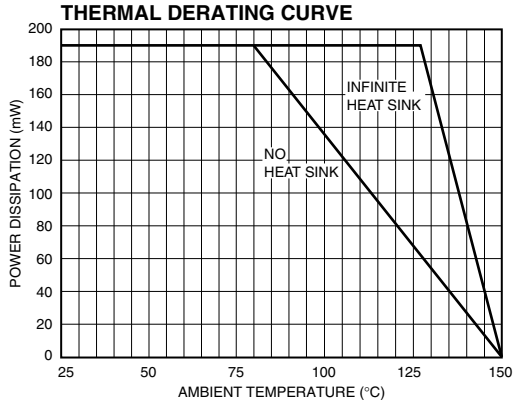

TYPICAL CHARACTERISTICS

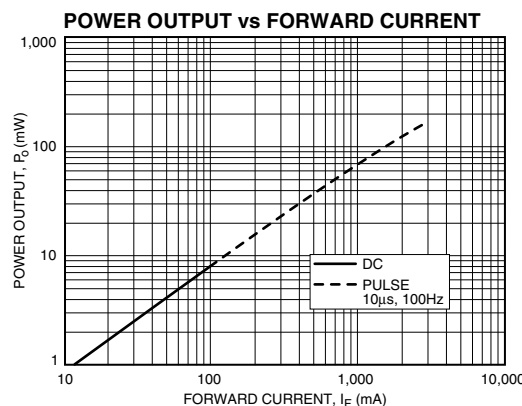
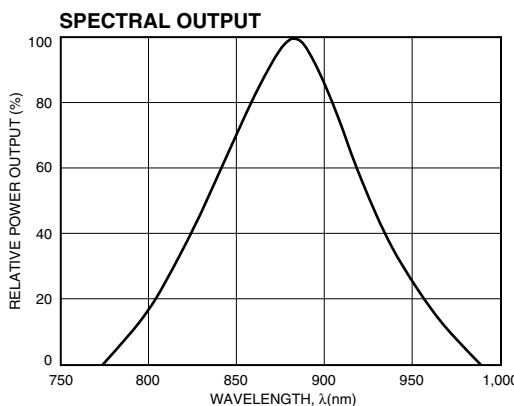
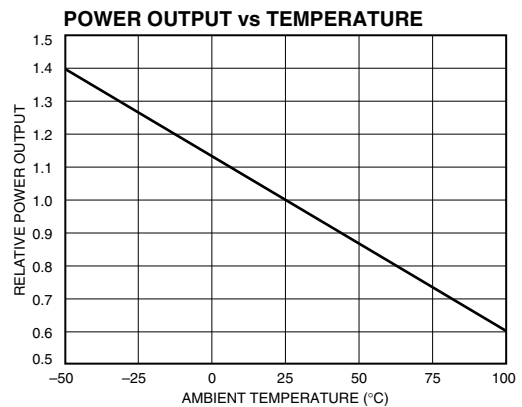
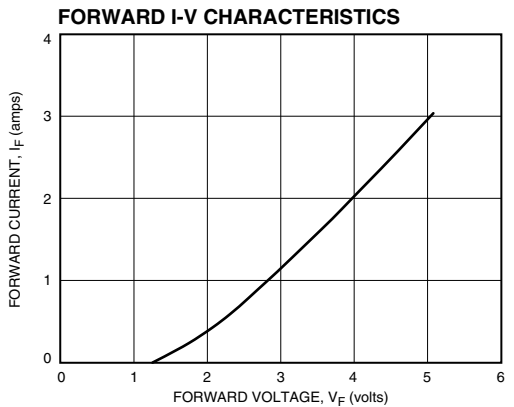
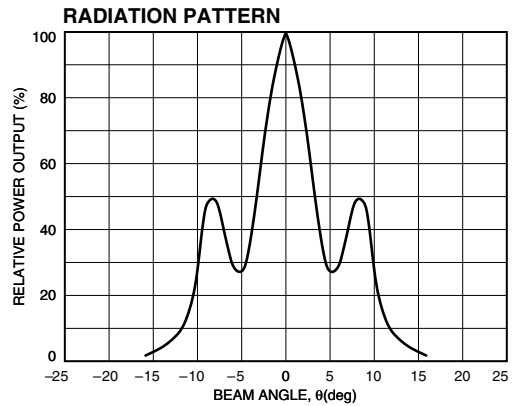
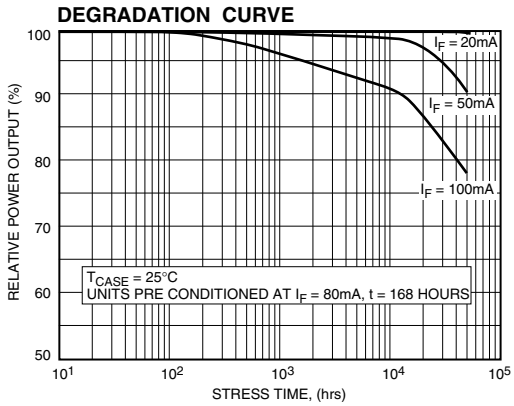

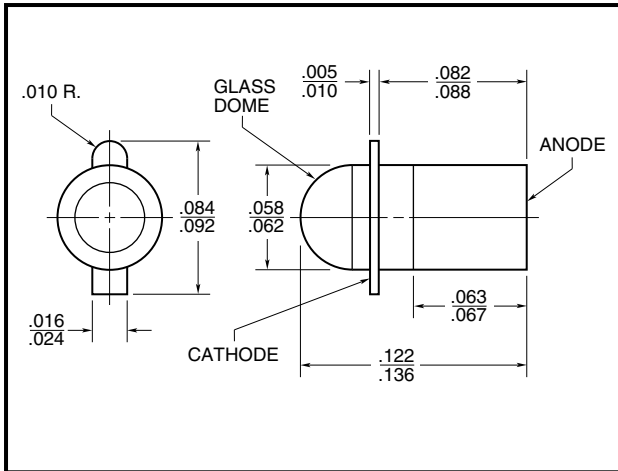
HI-REL GaAlAs IR EMITTERS**OD-880PP****FEATURES**

- High reliability LPE GaAlAs IRLEDs
- High power output
- 880nm peak emission
- Hermetically sealed miniature pill package
- MIL-S-19500 screening available
- No internal coatings

All surfaces are gold plated. Dimensions are nominal values in inches unless otherwise specified. Window caps are welded to the case.

ELECTRO-OPTICAL CHARACTERISTICS AT 25°C

PARAMETERS	TEST CONDITIONS	MIN	TYP	MAX	UNITS
Total Power Output, P_o	$I_F = 50\text{mA}$	2	2.2		mW
Peak Emission Wavelength, λ_p	$I_F = 50\text{mA}$		880		nm
Spectral Bandwidth at 50%, $\Delta\lambda$			80		nm
Half Intensity Beam Angle, θ			25		Deg
Forward Voltage, V_F	$I_F = 50\text{mA}$		1.4	1.6	Volts
Reverse Breakdown Voltage, V_R	$I_R = 10\mu\text{A}$	5	30		Volts
Capacitance, C	$V_R = 0\text{V}$		17		pF
Rise Time			0.5		μsec
Fall Time			0.5		μsec

ABSOLUTE MAXIMUM RATINGS AT 25°C CASE

Power Dissipation ¹	190mW
Continuous Forward Current	100mA
Peak Forward Current (10 μs , 400Hz) ²	3A
Reverse Voltage	5V
Lead Soldering Temperature (10sec)	240°C
Storage and Operating Temperature Range	-55°C to 125°C

¹Derate per Thermal Derating Curve above 25°C

²Derate linearly above 25°C

HI-REL GaAlAs IR EMITTERS

OD-880PP

MAXIMUM RATINGS

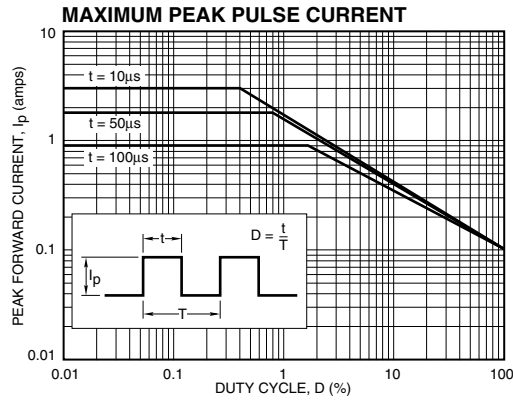

TYPICAL CHARACTERISTICS

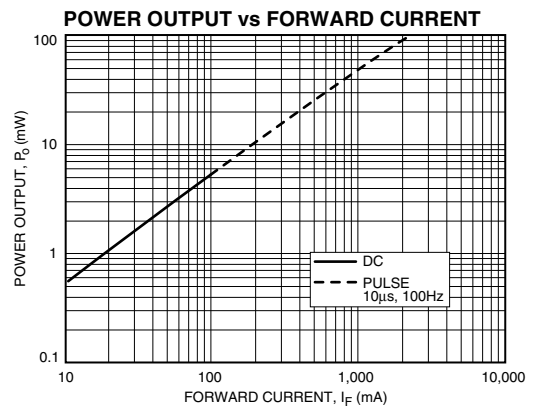
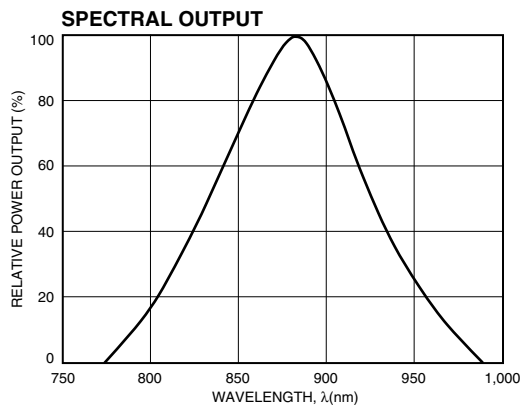
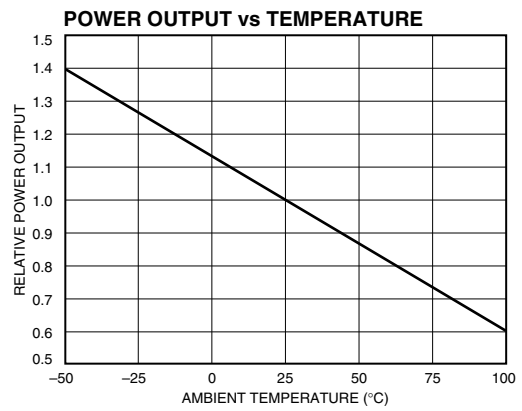
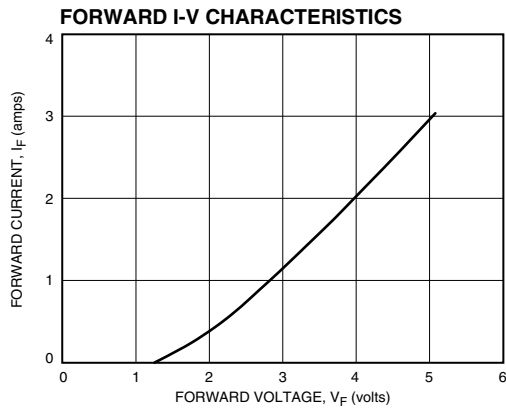
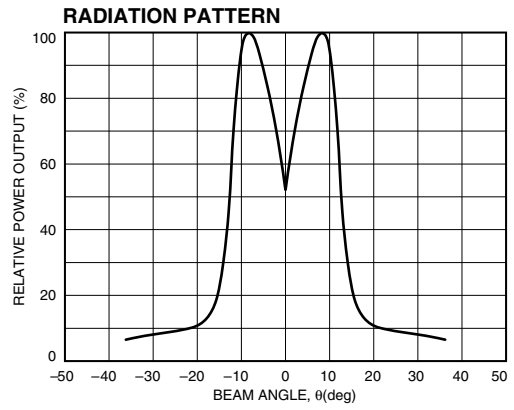
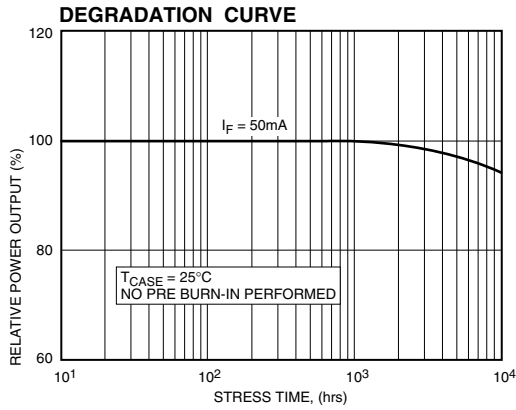

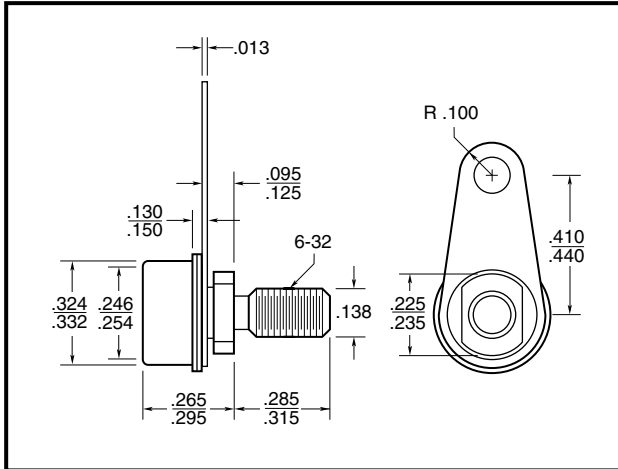
HI-REL GaAlAs IR EMITTERS**OD-50J****FEATURES**

- High reliability LPE GaAlAs IRLEDs
- High power output
- 880nm peak emission
- Four wire bonds on chip corners
- Hermetically sealed stud package
- MIL-S-19500 screening available
- No internal coatings

All surfaces are gold plated. Dimensions are nominal values in inches unless otherwise specified. Window caps are welded to the case.

ELECTRO-OPTICAL CHARACTERISTICS AT 25°C

PARAMETERS	TEST CONDITIONS	MIN	TYP	MAX	UNITS
Total Power Output, P_o	$I_F = 300\text{mA}$	20	25		mW
Peak Emission Wavelength, λ_p	$I_F = 50\text{mA}$		880		nm
Spectral Bandwidth at 50%, $\Delta\lambda$			80		nm
Half Intensity Beam Angle, θ			115		Deg
Forward Voltage, V_F	$I_F = 300\text{mA}$		1.5	1.8	Volts
Reverse Breakdown Voltage, V_R	$I_R = 10\mu\text{A}$	5	40		Volts
Capacitance, C	$V_R = 0\text{V}$		90		pF
Rise Time			0.7		μsec
Fall Time			0.7		μsec

ABSOLUTE MAXIMUM RATINGS AT 25°C CASE

Power Dissipation ¹	900mW
Continuous Forward Current	450mA
Peak Forward Current (10 μs , 700Hz) ²	12A
Reverse Voltage	5V
Lead Soldering Temperature (1/16" from case for 10sec)	240°C

¹Derate per Thermal Derating Curve above 25°C

²Derate linearly above 25°C

THERMAL PARAMETERS

Storage and Operating Temperature Range	-65°C TO 150°C
Maximum Junction Temperature	150°C
Thermal Resistance, R_{THJA} ¹	120°C/W Typical
Thermal Resistance, R_{THJA} ²	35°C/W Typical

¹Heat transfer minimized by measuring in still air with minimum heat conducting through leads

²Air circulating at a rapid rate to keep case temperature at 25°C

HI-REL GaAlAs IR EMITTERS

OD-50J

MAXIMUM RATINGS

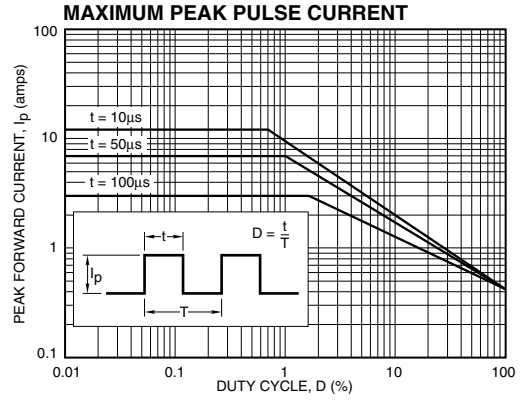
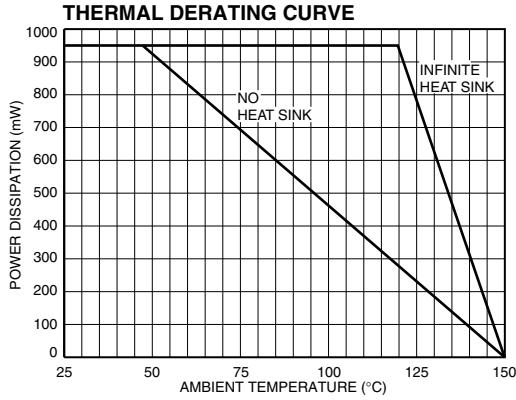

TYPICAL CHARACTERISTICS

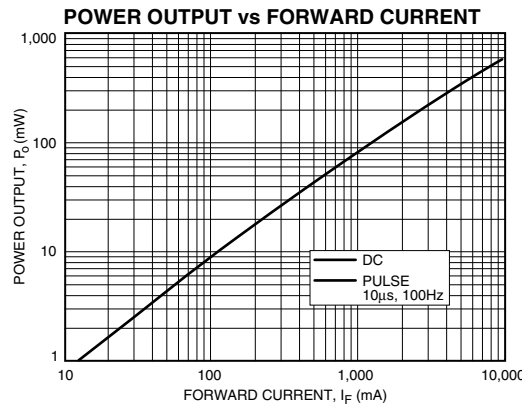
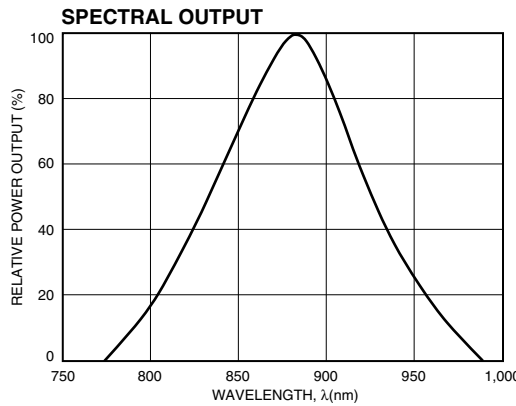
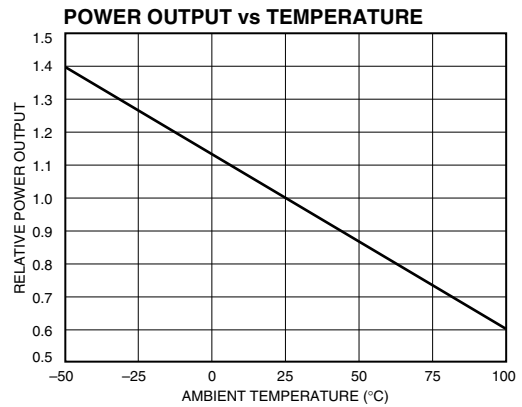
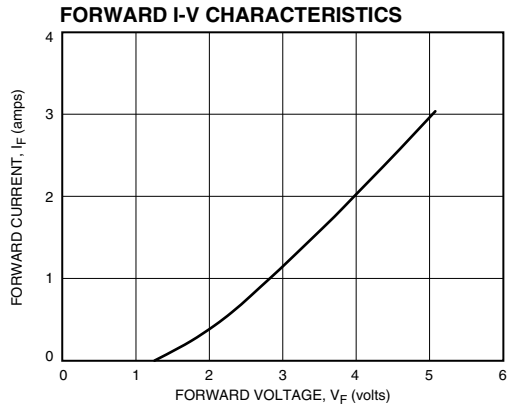
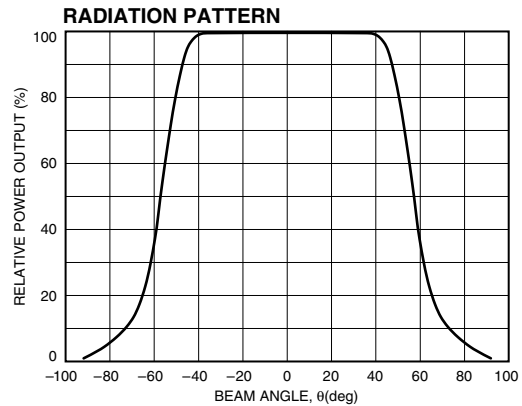
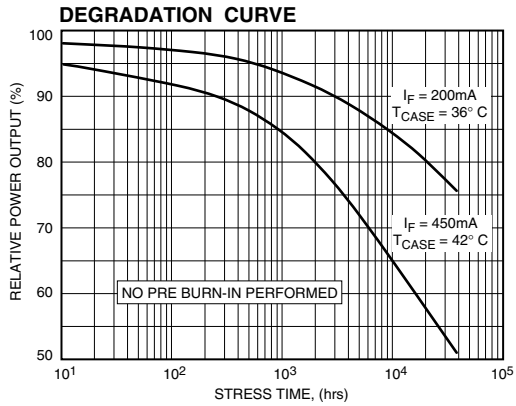

Park, California 91320