

TC-71 CHOKE

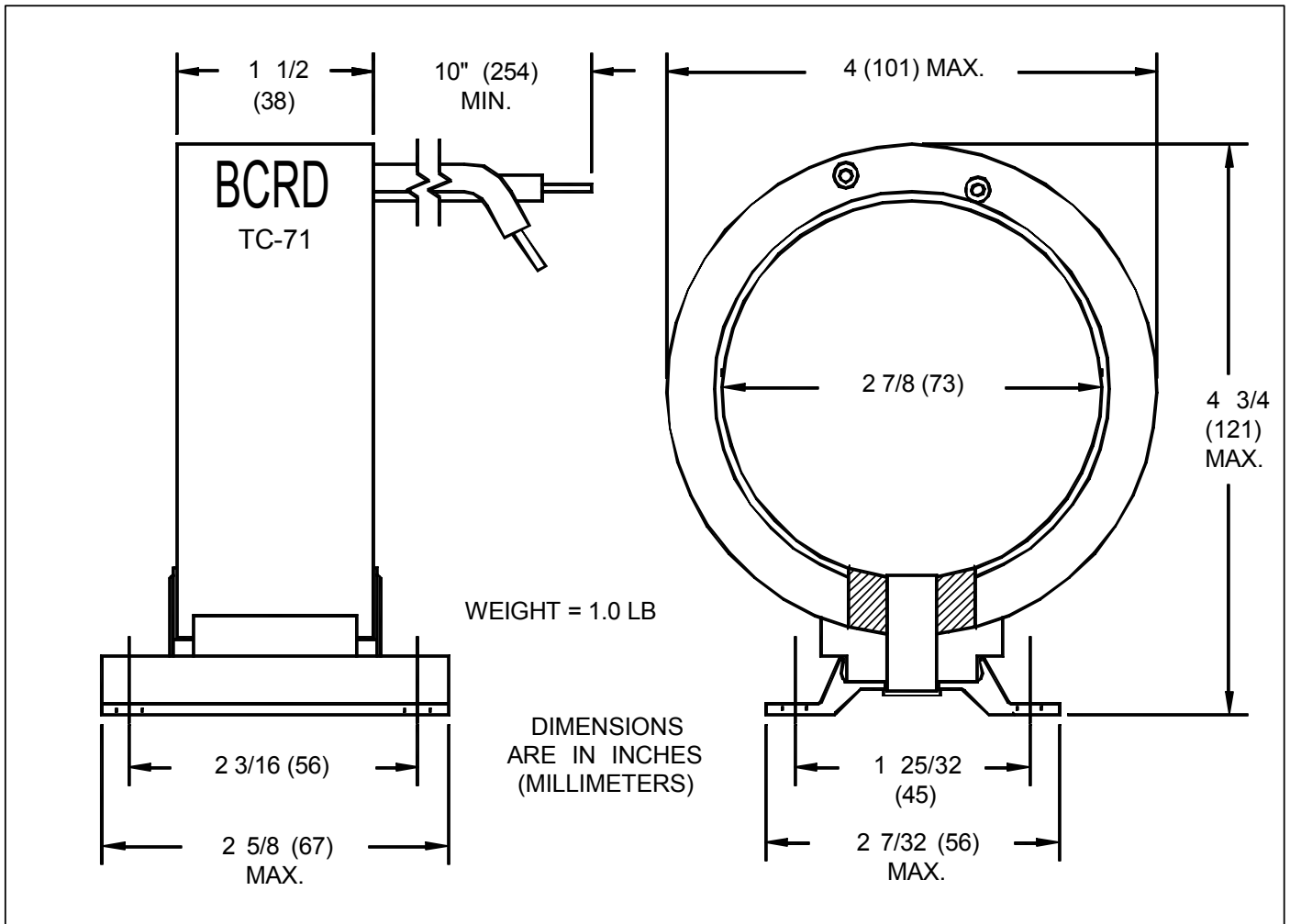

OUTLINE & MOUNTING DIMENSIONS

SPECIFICATIONS

Inductance	600 uH
DC Resistance	0.25 ohms
Voltage	5 KV

Maximum Peak Current	2000 Amps
Maximum RMS Current	8 Amps

For more information email us at generalinquiries@excelitas.com or visit our website at www.excelitas.com
All values are nominal; specification subject to change without notice.

Worldwide Headquarters
Excelitas Technologies44370
Christy Street
Fremont, CA 94538
Telephone: +1 510-979-6500
Toll Free (North America): +1 800-775-OPTO (6786)
Fax: +510-687-1140
generalinquiries@excelitas.com

Europe Headquarters
Excelitas Technologies
Wenzel-Jaksch-Str. 31
D-65199 Wiesbaden, Germany
Telephone: +49 611 492 430
Fax: +49 611 492 165

Asia Headquarters
Excelitas Technologies
47 Ayer Rajah Crescent #06-12
Singapore 139947
Telephone: +65 6770 2022
Fax: +65 6775 1008

EXCELITAS
TECHNOLOGIES