

PD413PI

High Speed Type Photodiode

■ Features

1. Built-in visible light cut-off filter
(Sensitivity wavelength range : 750 to 1070 nm)
2. Half intensity angle : $\Delta\theta : \pm 45^\circ$

■ Applications

1. Portable information terminal equipment
2. Personal computers
3. Printers

■ Outline Dimensions

(Unit : mm)

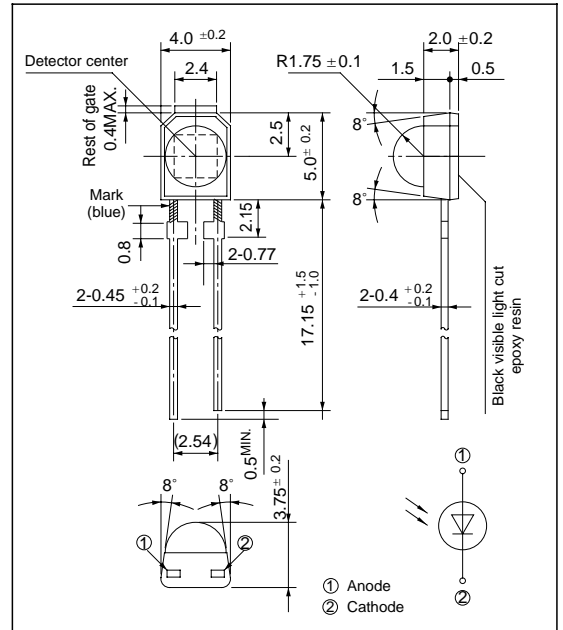

■ Absolute Maximum Ratings

(Ta=25°C)

Parameter	Symbol	Rating	Unit
Reverse voltage	V_R	32	V
Power dissipation	P	150	mW
Operating temperature	T_{opr}	- 25 to + 85	°C
Storage temperature	T_{stg}	- 40 to + 100	°C
*1 Soldering temperature	T_{sol}	260	°C

*1 For 5 seconds at the position of 2.15 mm from bottom face of resin package

■ Electro-optical Characteristics

(Ta=25 °C)

Parameter	Symbol	Conditions	MIN.	TYP.	MAX.	Unit
Shortcircuit current	I_{SC}	$E_v^{*2} = 100 \text{ lx}$	4.5	5.4	8.1	μA
Dark current	I_d	$V_R = 10\text{V}, E_v = 0$	-	-	10	nA
Forward voltage	V_F	$I_F = 1\text{mA}$	-	-	1	V
Terminal capacitance	C_t	$V_R = 3\text{V}, f = 1\text{MHz}$	-	20	35	pF
Peak sensitivity wavelength	λ_p	-	-	960	-	nm
Half intensity angle	$\Delta\theta$	-	-	± 45	-	°
Response time	t_r, t_f	$R_L = 1\text{k}\Omega, V_R = 10\text{V}$	-	200	-	ns

*2 E_v : Illuminance by CIE standard light source A (tungsten lamp)

Fig. 1 Power Dissipation vs. Ambient Temperature

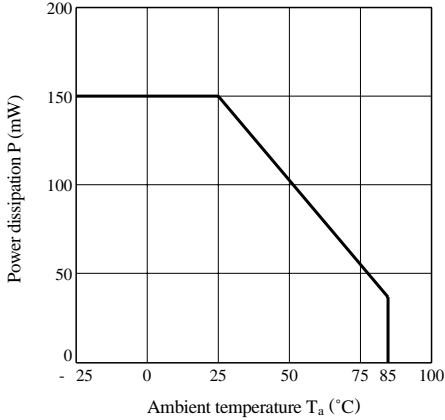

Fig. 2 Spectral Sensitivity

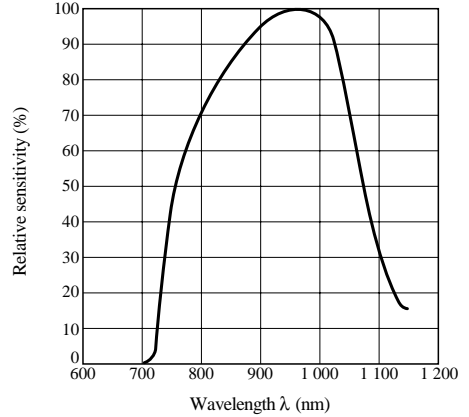

Fig. 3 Shortcircuit Current vs. Illuminance

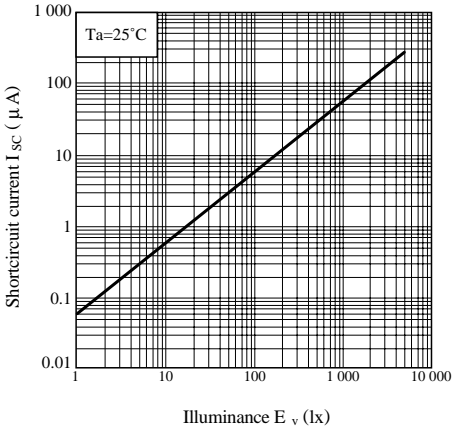

Fig. 4 Dark Current vs. Ambient Temperature

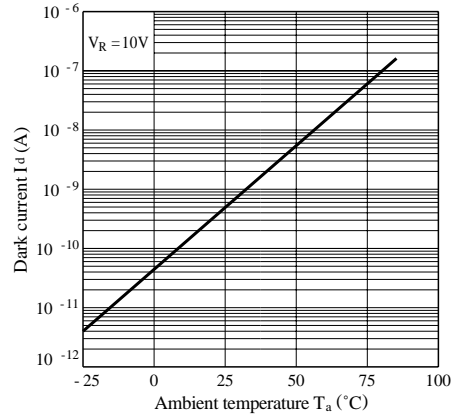

Fig. 5 Dark Current vs. Reverse Voltage

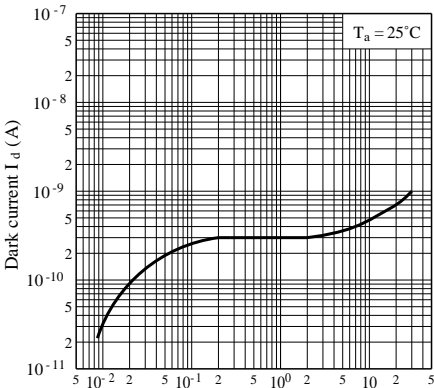

Fig. 6 Terminal Capacitance vs. Reverse Voltage

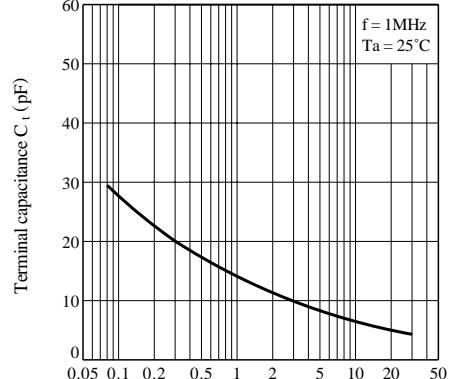

Fig. 7 Relative Output vs. Ambient Temperature
(Detector : GL537/GL538)

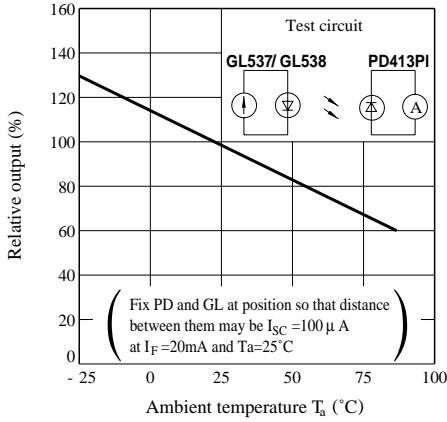

Fig. 8 Radiation Diagram
($T_a = 25^{\circ}\text{C}$)

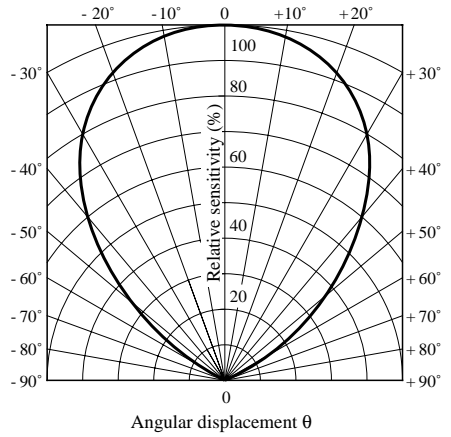

Fig. 9 Relative Output vs. Distance
(Detector : GL537/GL538)

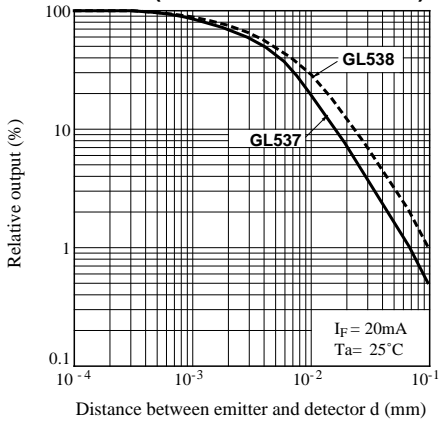
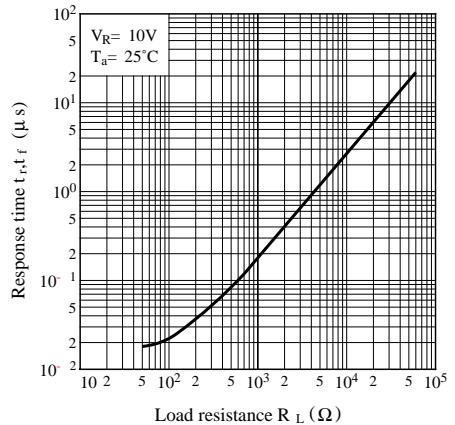
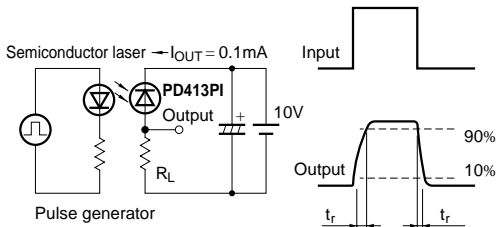

Fig. 10 Response Time vs. Load Resistance



Test Circuit for Response Time



● Please refer to the chapter "Precautions for Use". (Page 78 to 93)