



Silicon NPN Phototransistor

Description

BPW77N is a very high sensitive silicon NPN epitaxial planar phototransistor in a standard TO-18 hermetically sealed metal case.

Its glass lens featuring a viewing angle of $\pm 10^\circ$ makes it insensitive to ambient straylight.

A base terminal is available to enable biasing and sensitivity control.

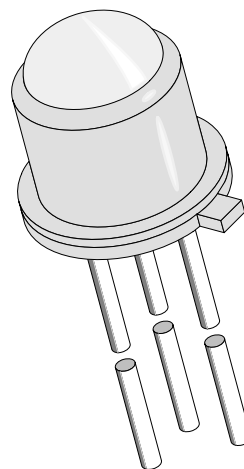

94 8486

Features

- Hermetically sealed case
- Lens window
- Narrow viewing angle $\varphi = \pm 10^\circ$
- Exact central chip alignment
- Base terminal available
- High photo sensitivity
- Suitable for visible and near infrared radiation
- Selected into sensitivity groups

Applications

Detector in electronic control and drive circuits

Absolute Maximum Ratings

$T_{amb} = 25^\circ\text{C}$

Parameter	Test Conditions	Symbol	Value	Unit
Collector Base Voltage		V_{CBO}	80	V
Collector Emitter Voltage		V_{CEO}	70	V
Emitter Base Voltage		V_{EBO}	5	V
Collector Current		I_C	50	mA
Peak Collector Current	$t_p/T = 0.5, t_p \leq 10 \text{ ms}$	I_{CM}	100	mA
Total Power Dissipation	$T_{amb} \leq 25^\circ\text{C}$	P_{tot}	250	mW
Junction Temperature		T_j	125	$^\circ\text{C}$
Storage Temperature Range		T_{stg}	-55...+125	$^\circ\text{C}$
Soldering Temperature	$t \leq 5 \text{ s}$	T_{sd}	260	$^\circ\text{C}$
Thermal Resistance Junction/Ambient		R_{thJA}	400	K/W
Thermal Resistance Junction/Case		R_{thJC}	150	K/W



Vishay Telefunken

Basic Characteristics

$T_{amb} = 25^{\circ}C$

Parameter	Test Conditions	Symbol	Min	Typ	Max	Unit
Collector Emitter Breakdown Voltage	$I_C = 1 \text{ mA}$	$V_{(BR)CE0}$	70			V
Collector Dark Current	$V_{CE} = 20 \text{ V}, E = 0$	I_{CEO}		1	100	nA
Collector Emitter Capacitance	$V_{CE} = 5 \text{ V}, f = 1 \text{ MHz}, E = 0$	C_{CEO}		6		pF
Angle of Half Sensitivity		ϕ		± 10		deg
Wavelength of Peak Sensitivity		λ_p		850		nm
Range of Spectral Bandwidth		$\lambda_{0.5}$		620...980		nm
Collector Emitter Saturation Voltage	$E_e = 1 \text{ mW/cm}^2,$ $\lambda = 950 \text{ nm}, I_C = 1 \text{ mA}$	V_{CEsat}		0.15	0.3	V
Turn-On Time	$V_S = 5 \text{ V}, I_C = 5 \text{ mA},$ $R_L = 100 \Omega$	t_{on}		6		μs
Turn-Off Time	$V_S = 5 \text{ V}, I_C = 5 \text{ mA},$ $R_L = 100 \Omega$	t_{off}		5		μs
Cut-Off Frequency	$V_S = 5 \text{ V}, I_C = 5 \text{ mA},$ $R_L = 100 \Omega$	f_c		110		kHz

Type Dedicated Characteristics

$T_{amb} = 25^{\circ}C$

Parameter	Test Conditions	Type	Symbol	Min	Typ	Max	Unit
Collector Light Current	$E_e = 1 \text{ mW/cm}^2,$ $\lambda = 950 \text{ nm}, V_{CE} = 5 \text{ V}$	BPW77NA	I_{ca}	7.5	10	15	mA
		BPW77NB	I_{ca}	10	20		mA

Typical Characteristics ($T_{amb} = 25^{\circ}C$ unless otherwise specified)

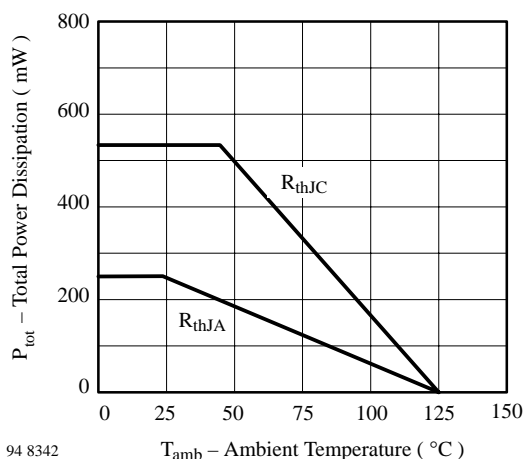

Figure 1. Total Power Dissipation vs. Ambient Temperature

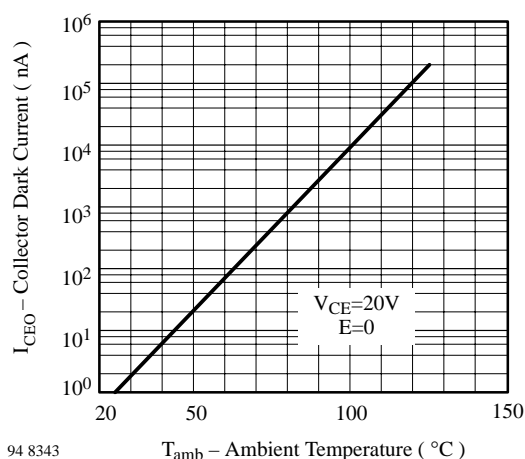
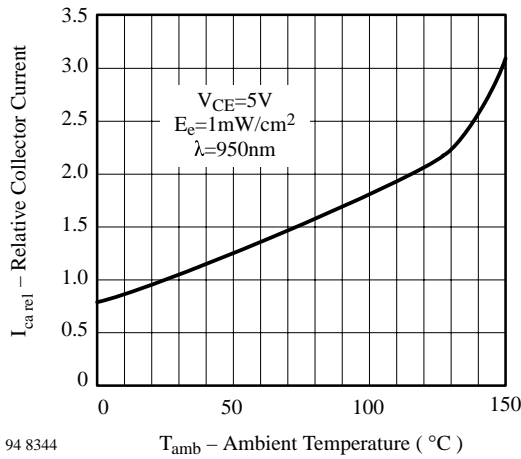
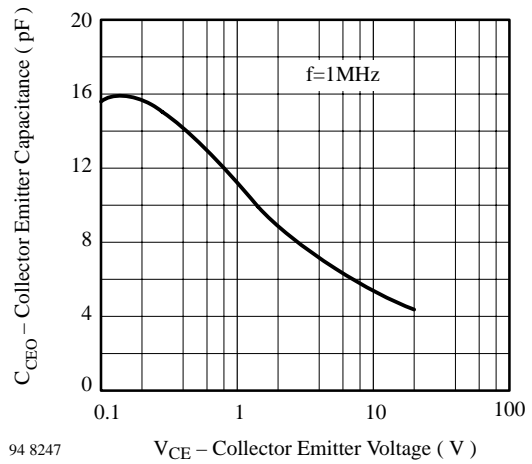

Figure 2. Collector Dark Current vs. Ambient Temperature



94 8344 T_{amb} – Ambient Temperature (°C)

Figure 3. Relative Collector Current vs. Ambient Temperature



94 8247 V_{CE} – Collector Emitter Voltage (V)

Figure 6. Collector Emitter Capacitance vs. Collector Emitter Voltage

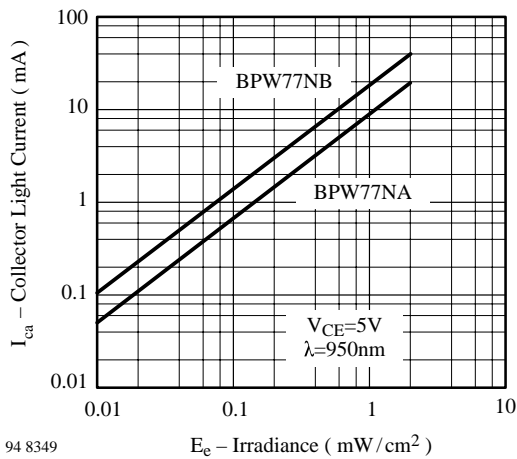

94 8349 E_e – Irradiance (mW/cm²)

Figure 4. Collector Light Current vs. Irradiance

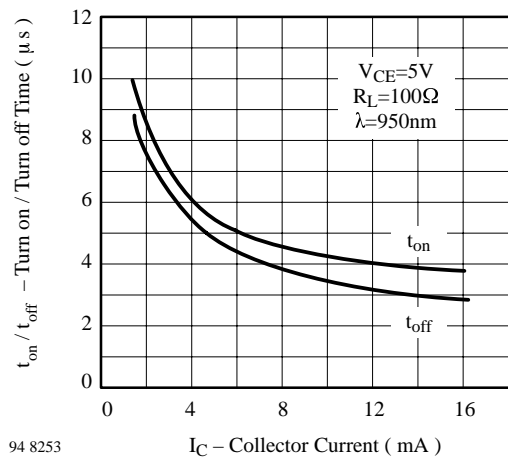

94 8253 I_C – Collector Current (mA)

Figure 7. Turn On/Turn Off Time vs. Collector Current

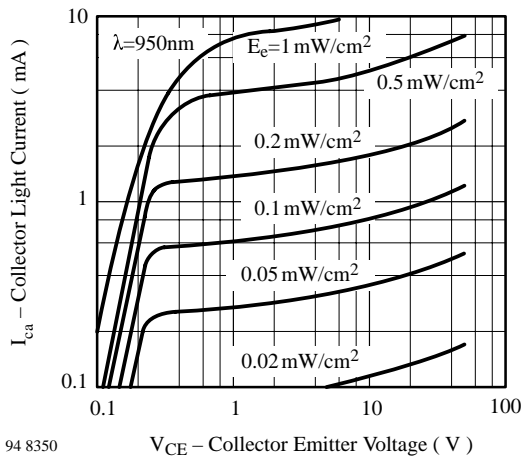

94 8350 V_{CE} – Collector Emitter Voltage (V)

Figure 5. Collector Light Current vs. Collector Emitter Voltage

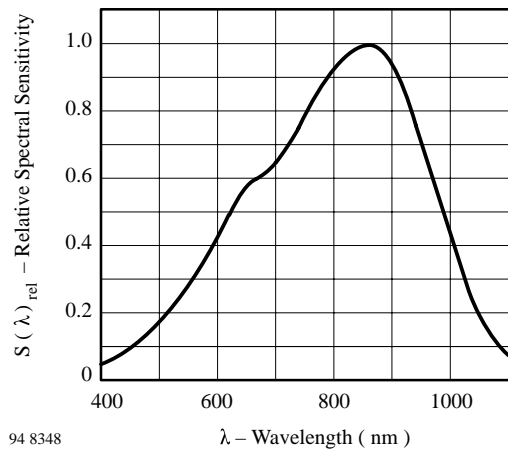

94 8348 λ – Wavelength (nm)

Figure 8. Relative Spectral Sensitivity vs. Wavelength

BPW77N



Vishay Telefunken

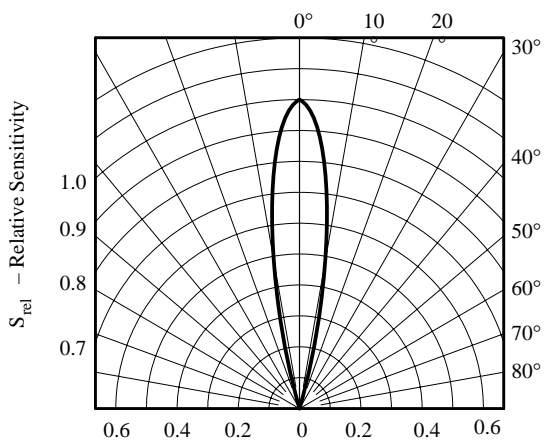

94 8351

Figure 9. Relative Radiant Sensitivity vs. Angular Displacement



Dimensions in mm

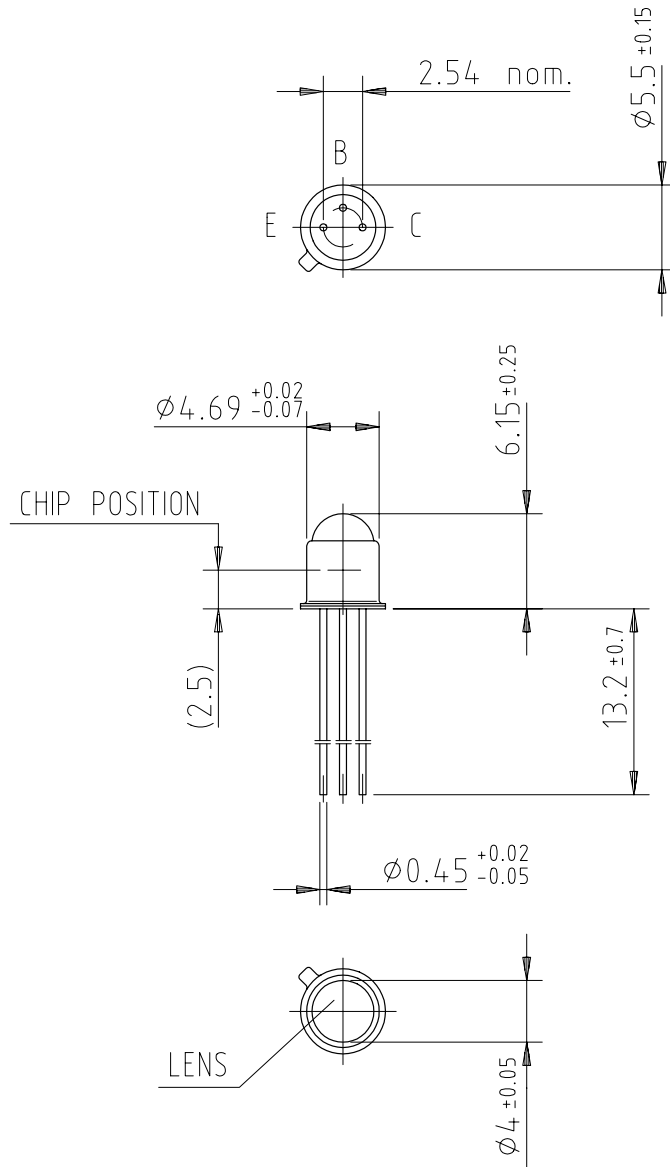

96 12180

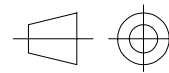

technical drawings
according to DIN
specifications



Vishay Telefunken

Ozone Depleting Substances Policy Statement

It is the policy of **Vishay Semiconductor GmbH** to

1. Meet all present and future national and international statutory requirements.
2. Regularly and continuously improve the performance of our products, processes, distribution and operating systems with respect to their impact on the health and safety of our employees and the public, as well as their impact on the environment.

It is particular concern to control or eliminate releases of those substances into the atmosphere which are known as ozone depleting substances (ODSs).

The Montreal Protocol (1987) and its London Amendments (1990) intend to severely restrict the use of ODSs and forbid their use within the next ten years. Various national and international initiatives are pressing for an earlier ban on these substances.

Vishay Semiconductor GmbH has been able to use its policy of continuous improvements to eliminate the use of ODSs listed in the following documents.

1. Annex A, B and list of transitional substances of the Montreal Protocol and the London Amendments respectively
2. Class I and II ozone depleting substances in the Clean Air Act Amendments of 1990 by the Environmental Protection Agency (EPA) in the USA
3. Council Decision 88/540/EEC and 91/690/EEC Annex A, B and C (transitional substances) respectively.

Vishay Semiconductor GmbH can certify that our semiconductors are not manufactured with ozone depleting substances and do not contain such substances.

We reserve the right to make changes to improve technical design and may do so without further notice.

Parameters can vary in different applications. All operating parameters must be validated for each customer application by the customer. Should the buyer use Vishay-Telefunken products for any unintended or unauthorized application, the buyer shall indemnify Vishay-Telefunken against all claims, costs, damages, and expenses, arising out of, directly or indirectly, any claim of personal damage, injury or death associated with such unintended or unauthorized use.

Vishay Semiconductor GmbH, P.O.B. 3535, D-74025 Heilbronn, Germany
Telephone: 49 (0) 7131 67 2831, Fax number: 49 (0) 7131 67 2423