

**DISCRETE SEMICONDUCTORS**

# DATA SHEET

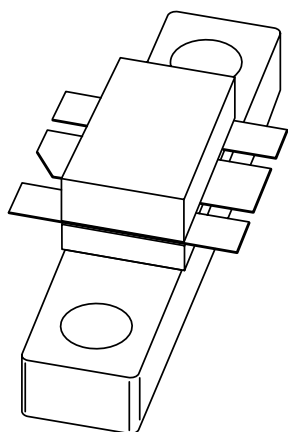

## **BLV920** UHF power transistor

Product specification  
Supersedes data of 1995 Apr 10

1997 Nov 17

**UHF power transistor****BLV920****FEATURES**

- Internal input matching to achieve high power gain and easy design of wideband circuits
- Emitter ballasting resistors for an optimum temperature profile
- Gold metallization ensures excellent reliability.

**APPLICATIONS**

- Base station transmitters in the 820 to 960 MHz range.

**PINNING - SOT171A**

PIN	SYMBOL	DESCRIPTION
1	e	emitter
2	e	emitter
3	b	base
4	c	collector
5	e	emitter
6	e	emitter

**DESCRIPTION**

NPN silicon planar epitaxial transistor intended for common emitter class-AB operation. The transistor is encapsulated in a 6-lead SOT171A flange envelope with a ceramic cap. All leads are isolated from the flange.

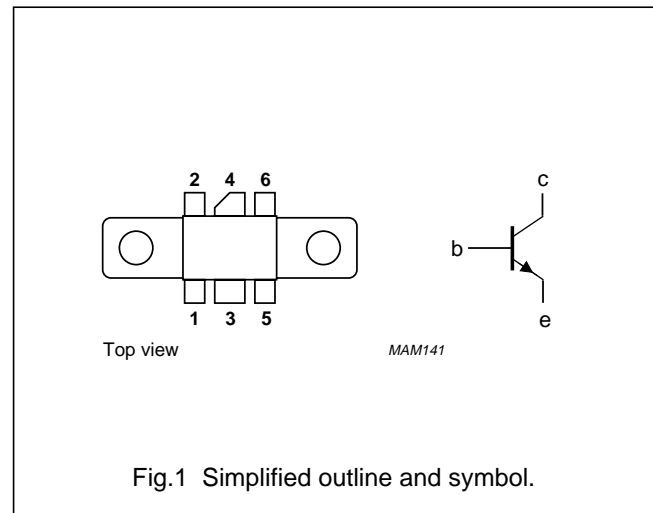
**QUICK REFERENCE DATA**

RF performance at  $T_h = 25\text{ }^\circ\text{C}$  in a common emitter test circuit.

MODE OF OPERATION	f (MHz)	$V_{CE}$ (V)	$P_L$ (W)	$G_p$ (dB)	$\eta_c$ (%)
CW, class-AB	960	26	20	$\geq 10$	$\geq 55$

**WARNING****Product and environmental safety - toxic materials**

This product contains beryllium oxide. The product is entirely safe provided that the BeO disc is not damaged. All persons who handle, use or dispose of this product should be aware of its nature and of the necessary safety precautions. After use, dispose of as chemical or special waste according to the regulations applying at the location of the user. It must never be thrown out with the general or domestic waste.

# UHF power transistor

# BLV920

## LIMITING VALUES

In accordance with the Absolute Maximum Rating System (IEC 134).

SYMBOL	PARAMETER	CONDITIONS	MIN.	MAX.	UNIT
$V_{CBO}$	collector-base voltage	open emitter	–	70	V
$V_{CEO}$	collector-emitter voltage	open base	–	30	V
$V_{EBO}$	emitter-base voltage	open collector	–	3	V
$I_C$	collector current (DC)		–	3	A
$I_{C(AV)}$	average collector current		–	3	A
$P_{tot}$	total power dissipation	up to $T_{mb} = 25\text{ °C}$	–	50	W
$T_{stg}$	storage temperature		–65	+150	°C
$T_j$	operating junction temperature		–	200	°C

## THERMAL CHARACTERISTICS

SYMBOL	PARAMETER	CONDITIONS	VALUE	UNIT
$R_{th\ j-mb}$	thermal resistance from junction to mounting base	$P_{tot} = 49\text{ W}; T_{mb} = 25\text{ °C}$	3.5	K/W
$R_{th\ mb-h}$	thermal resistance from mounting base to heatsink		0.4	K/W

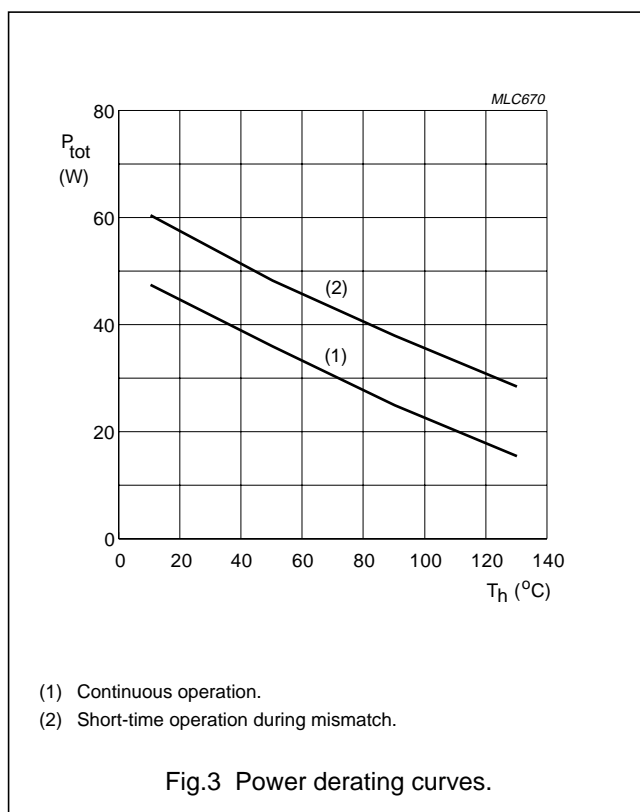
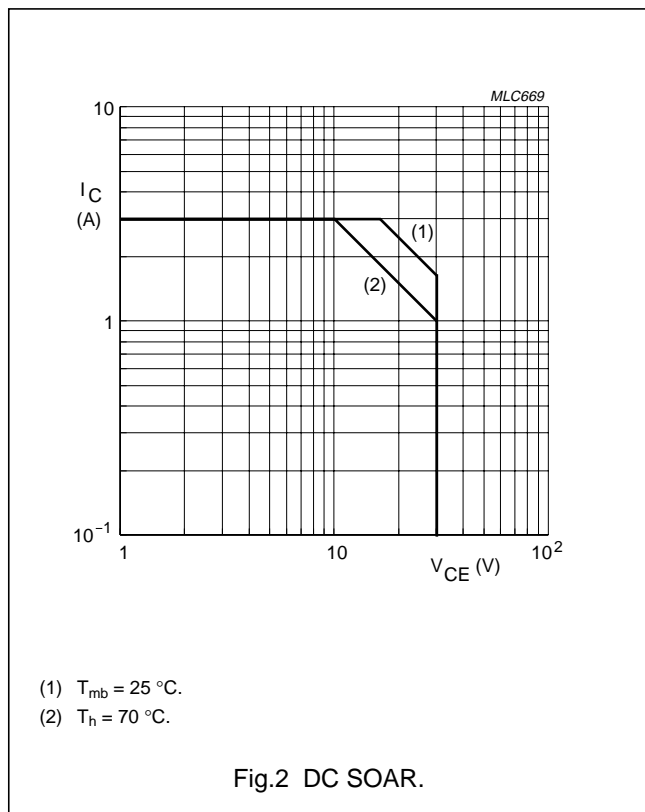

UHF power transistor

BLV920

CHARACTERISTICS

T<sub>j</sub> = 25 °C unless otherwise specified.

SYMBOL	PARAMETER	CONDITIONS	MIN.	TYP.	MAX.	UNIT
V <sub>(BR)CBO</sub>	collector-base breakdown voltage	open emitter; I <sub>C</sub> = 15 mA	70	–	–	V
V <sub>(BR)CEO</sub>	collector-emitter breakdown voltage	open base; I <sub>C</sub> = 30 mA	30	–	–	V
V <sub>(BR)EBO</sub>	emitter-base breakdown voltage	open collector; I <sub>E</sub> = 0.6 mA	3	–	–	V
I <sub>CES</sub>	collector leakage current	V <sub>BE</sub> = 0; V <sub>CE</sub> = 28 V	–	–	1.5	mA
h <sub>FE</sub>	DC current gain	V <sub>CE</sub> = 10 V; I <sub>C</sub> = 1 A; note 1	30	–	120	
C <sub>c</sub>	collector capacitance	V <sub>CB</sub> = 26 V; I <sub>E</sub> = i <sub>e</sub> = 0; f = 1 MHz	–	17	–	pF
C <sub>re</sub>	feedback capacitance	V <sub>CE</sub> = 26 V; I <sub>C</sub> = 0; f = 1 MHz	–	11	–	pF

Note

1. Measured under pulsed conditions: t<sub>p</sub> ≤ 500 μs; δ ≤ 0.01.

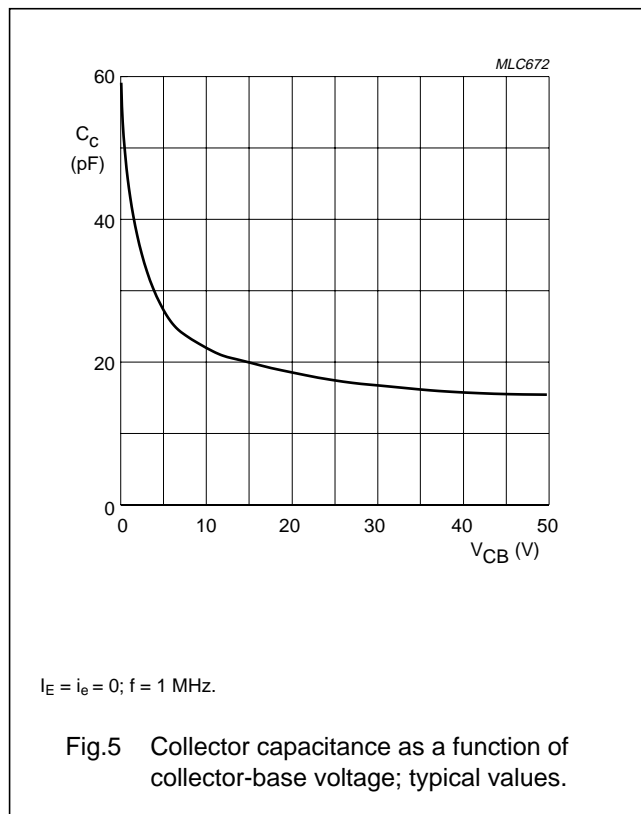
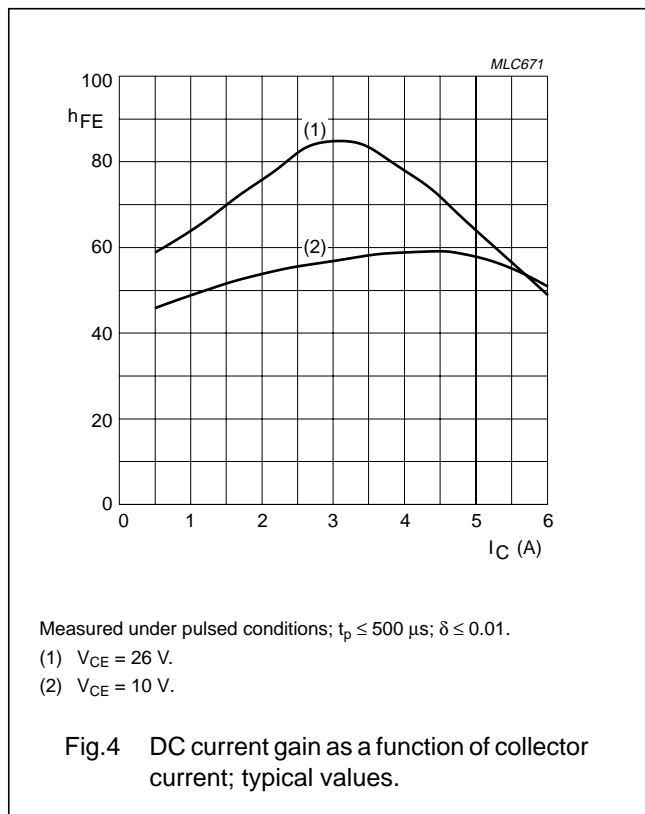

# UHF power transistor

# BLV920

## APPLICATION INFORMATION

RF performance at  $T_h = 25\text{ }^\circ\text{C}$  in a common emitter, class-AB test circuit;  $R_{th\ mb-h} = 0.4\text{ K/W}$ .

MODE OF OPERATION	f (MHz)	$V_{CE}$ (V)	$I_{CQ}$ (mA)	$P_L$ (W)	$G_p$ (dB)	$\eta_c$ (%)
CW, class-AB	960	26	50	20	$\geq 10$	$\geq 55$

### Ruggedness in class-AB operation

The BLV920 is capable of withstanding a load mismatch corresponding to  $VSWR = 20 : 1$  through all phases at rated output power, under the following conditions:  $V_{CE} = 26\text{ V}$ ;  $f = 960\text{ MHz}$ ;  $I_{CQ} = 50\text{ mA}$ ;  $T_h = 25\text{ }^\circ\text{C}$ ;  $R_{th\ mb-h} = 0.4\text{ K/W}$ .

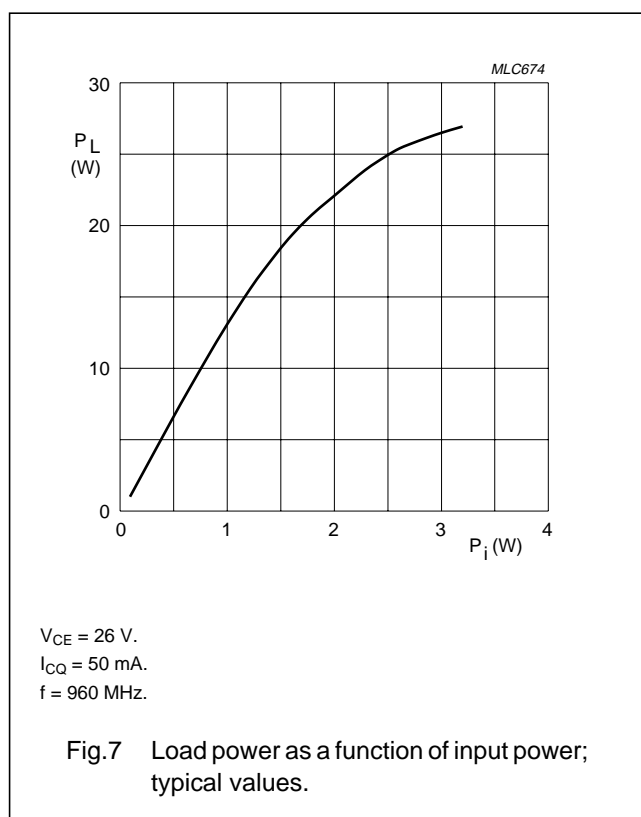
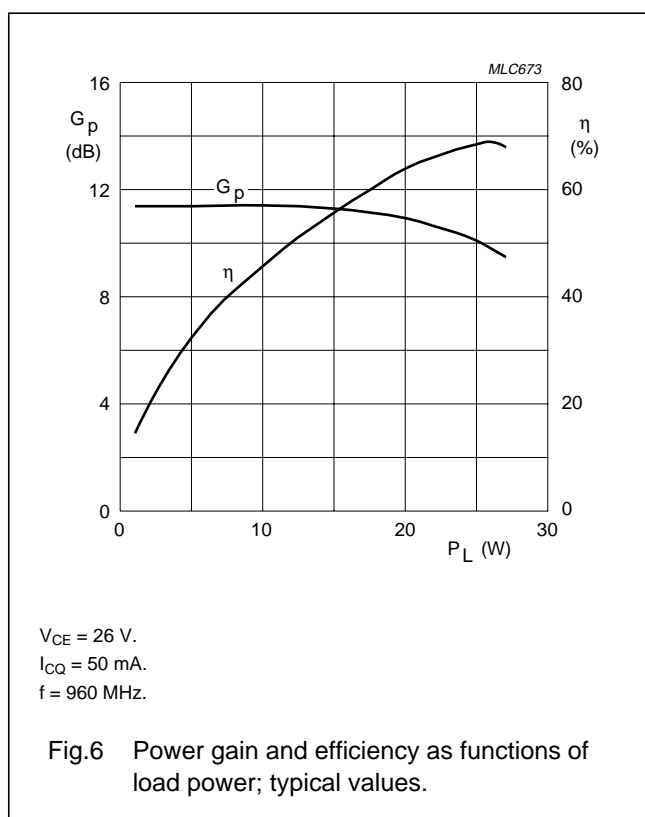

## UHF power transistor

## BLV920

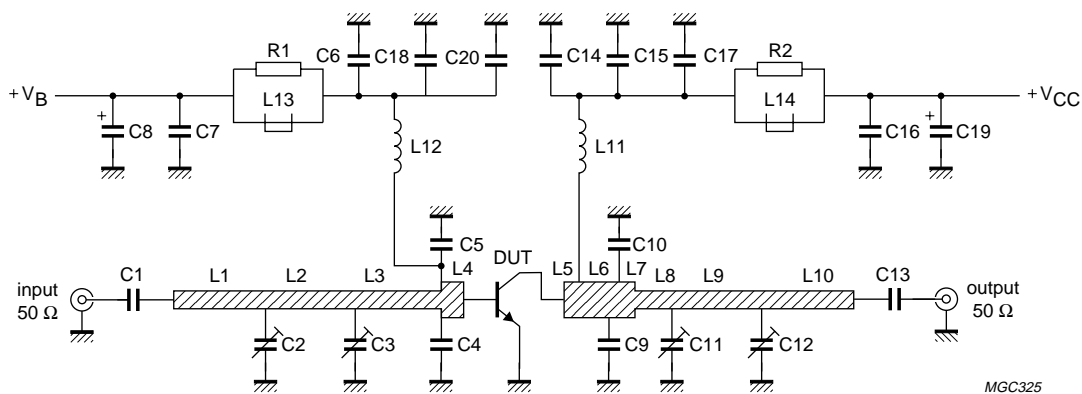
Fig.8 Class-AB test circuit at  $f = 960$  MHz.

## List of components (see Figs 8 and 9)

COMPONENT	DESCRIPTION	VALUE	DIMENSIONS	CATALOGUE No.
C1, C13	multilayer ceramic chip capacitor; note 1	43 pF		
C2, C3, C11, C12	film dielectric trimmer	1.4 pF to 5.5 pF		2222 809 09001
C4, C5	multilayer ceramic chip capacitor; note 2	10 pF		
C6, C17	multilayer ceramic chip capacitor; note 1	150 pF		
C7, C16	ceramic capacitor	22 nF		2222 640 08223
C8, C19	solid aluminium capacitor	10 $\mu$ F, 63 V		2222 030 38109
C14	multilayer ceramic chip capacitor; note 1	20 pF		
C9, C10	multilayer ceramic chip capacitor; note 2	11 pF		
C20	multilayer ceramic chip capacitor; note 1	1 nF		
C15, C18	multilayer ceramic chip capacitor; note 1	62 pF		
L1	stripline; note 3	50 $\Omega$	length 16.8 mm width 2.4 mm	
L2	stripline; note 3	50 $\Omega$	length 14.8 mm width 2.4 mm	
L3	stripline; note 3	50 $\Omega$	length 13.7 mm width 2.4 mm	

## UHF power transistor

BLV920

COMPONENT	DESCRIPTION	VALUE	DIMENSIONS	CATALOGUE No.
L4	stripline; note 3	43 $\Omega$	length 3.5 mm width 3 mm	
L5	stripline; note 3	43 $\Omega$	length 6.4 mm width 3 mm	
L6	stripline; note 3	43 $\Omega$	length 5.8 mm width 3 mm	
L7	stripline; note 3	43 $\Omega$	length 2.4 mm width 3 mm	
L8	stripline; note 3	50 $\Omega$	length 3 mm width 2.4 mm	
L9	stripline; note 3	50 $\Omega$	length 15.5 mm width 2.4 mm	
L10	stripline; note 3	50 $\Omega$	length 20 mm width 2.4 mm	
L11	4 turns enamelled 0.8 mm copper wire	45 nH	int. diameter 4mm length 5 mm leads 2 $\times$ 5 mm	
L12	3 turns enamelled 0.8 mm copper wire	30 nH	int. diameter 3mm length 5 mm leads 2 $\times$ 5 mm	
L13, L14	grade 3B Ferroxcube wideband RF choke			4312 020 36642
R1, R2	metal film resistor	10 $\Omega$ , 0.4 W		2322 151 71009

**Notes**

1. American Technical Ceramics type 100B or capacitor of same quality.
2. American Technical Ceramics type 100A or capacitor of same quality.
3. The striplines are on double-clad PCB with PTFE fibre-glass dielectric ( $\epsilon_r = 2.2$ ); thickness  $\frac{1}{32}$ ".

UHF power transistor

BLV920

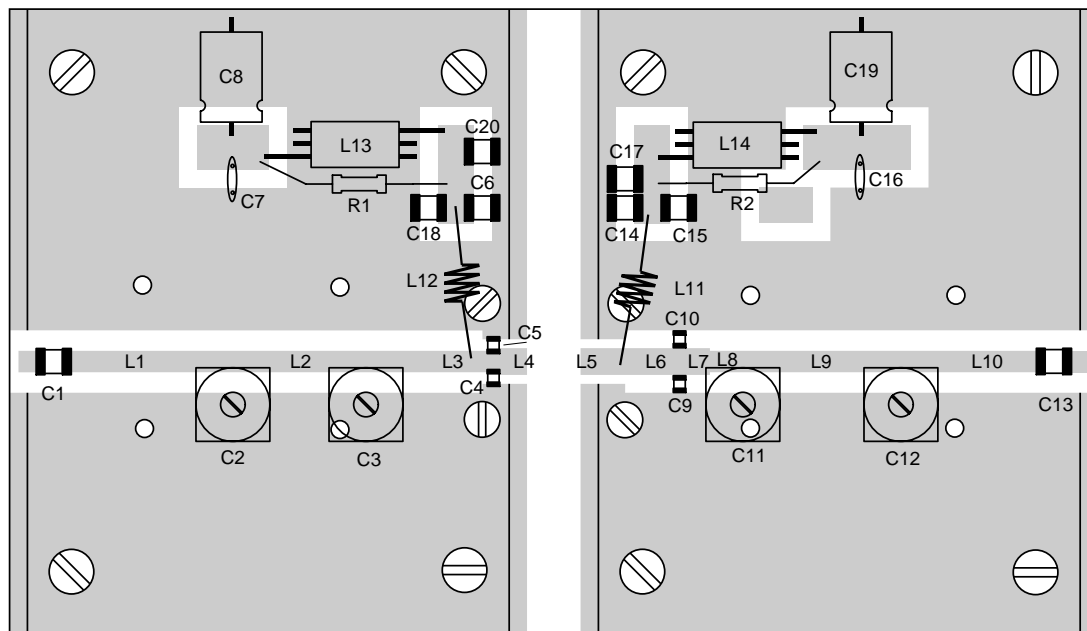
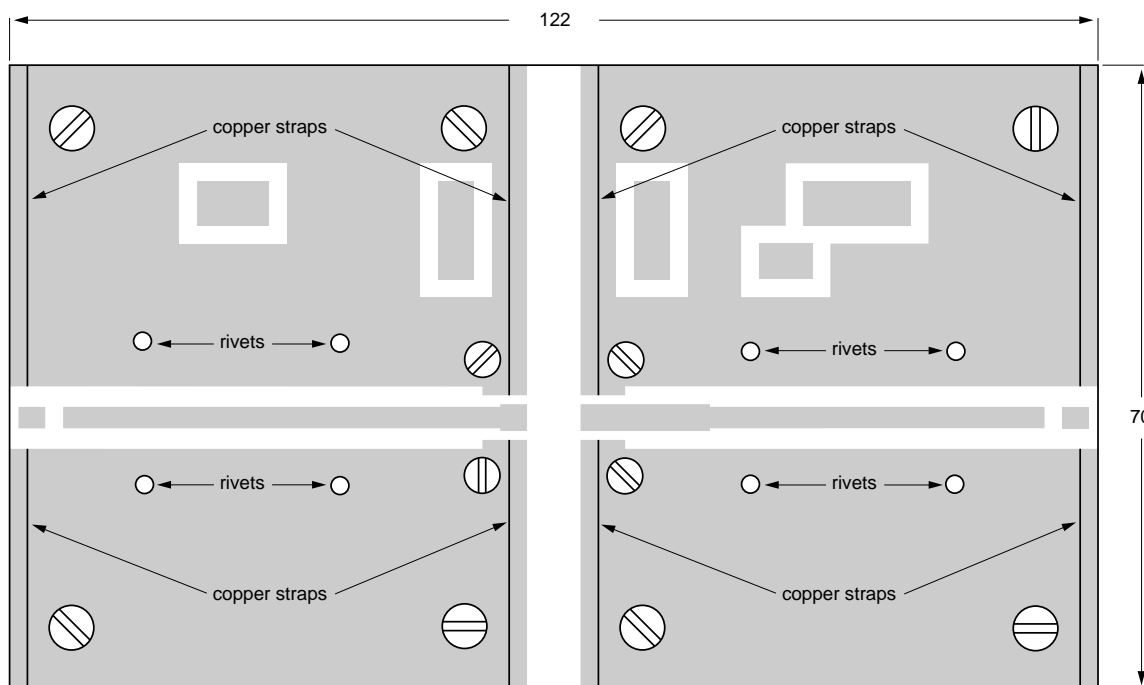

MGC326

Dimensions in mm.

The components are located on one side of the PTFE fibre-glass board, the other side being fully metallized to serve as an earth. Earth connections are made by fixing screws, hollow rivets and copper straps around the board and under the emitters to provide a direct contact between the component side and the ground plane.

Fig.9 Component layout for 960 MHz class-AB test circuit.



UHF power transistor

BLV920

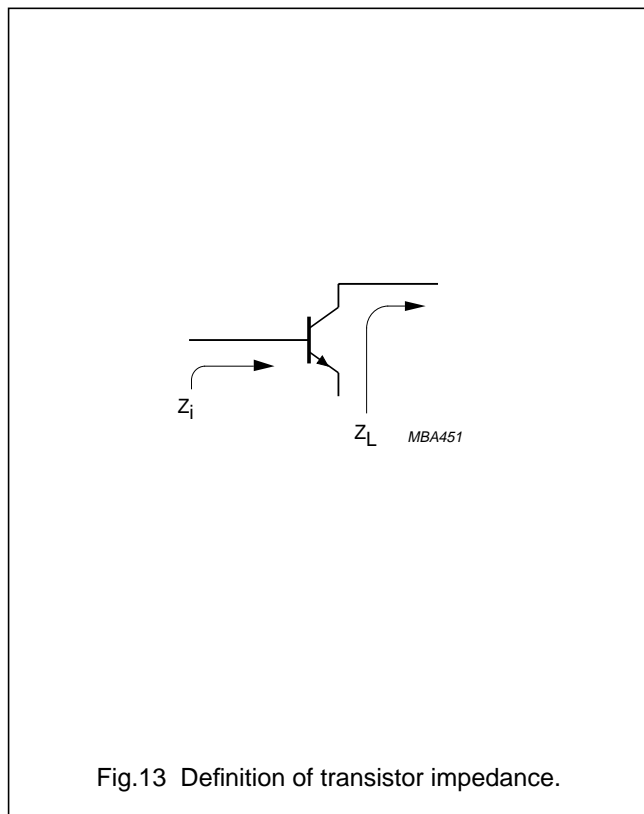
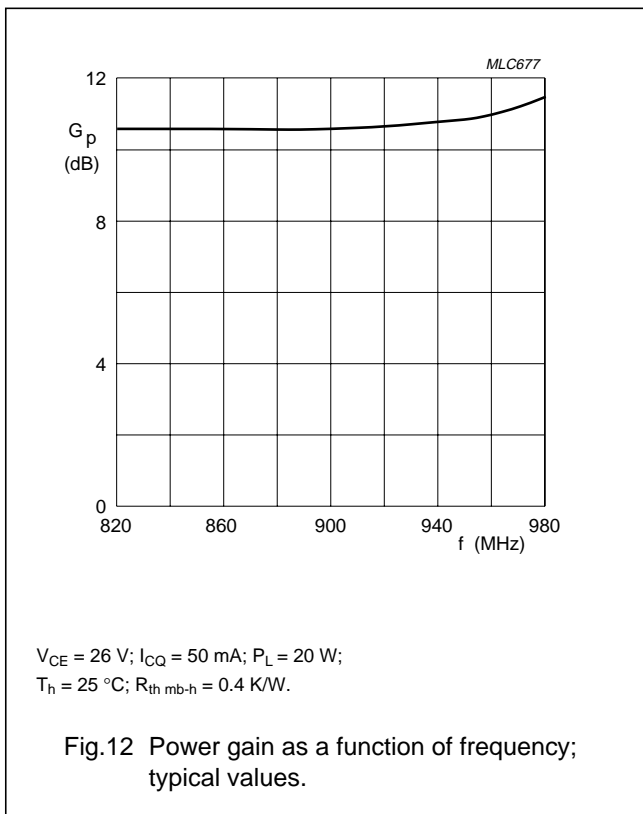
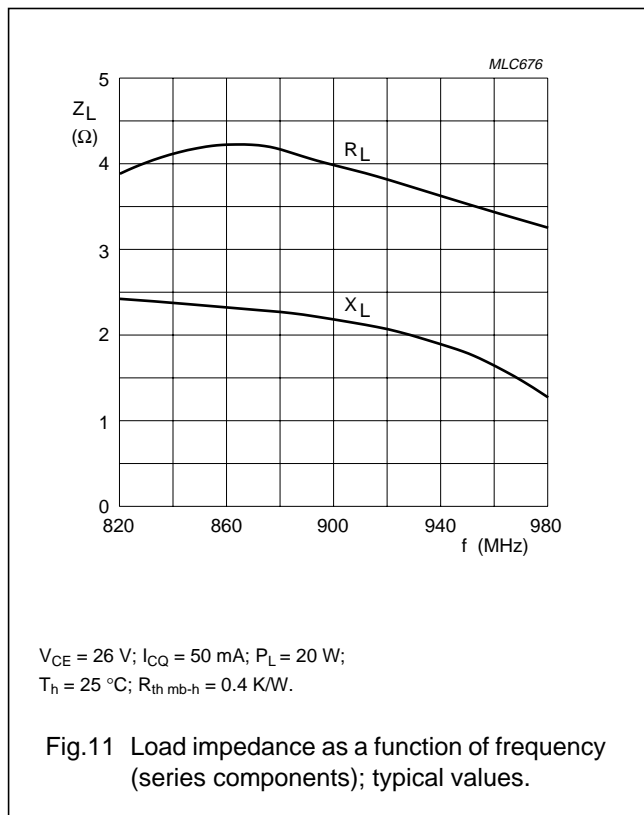
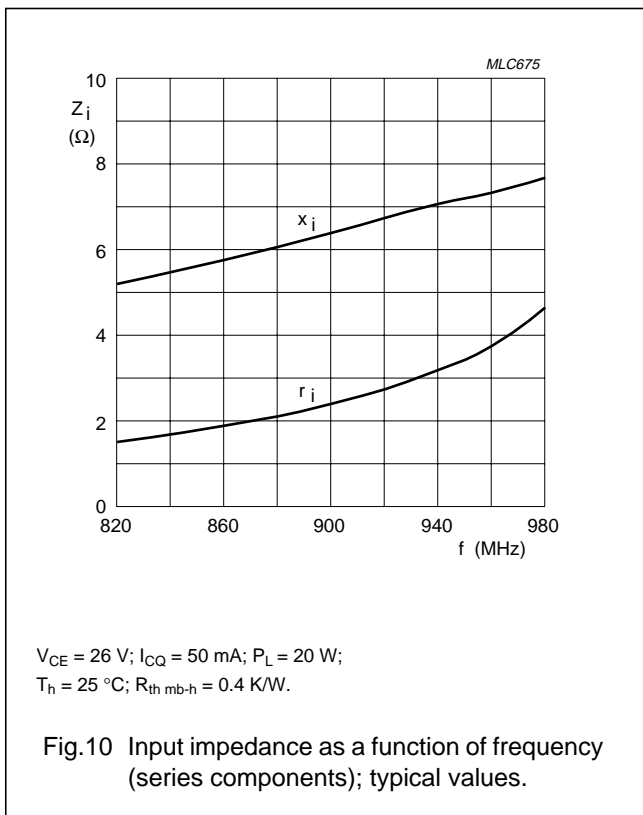

UHF power transistor

BLV920

PACKAGE OUTLINE

Flanged ceramic package; 2 mounting holes; 6 leads

SOT171A

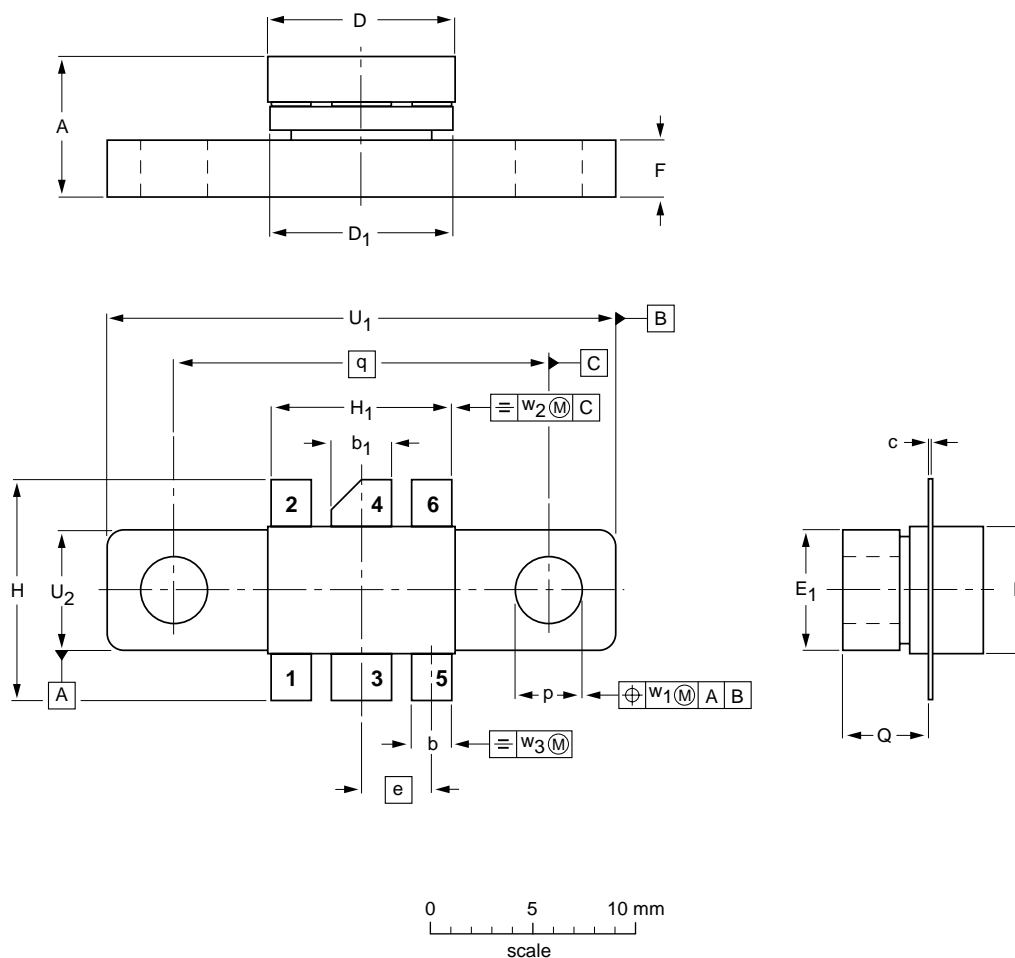

DIMENSIONS (millimetre dimensions are derived from the original inch dimensions)

UNIT	A	b	b <sub>1</sub>	c	D	D <sub>1</sub>	E	E <sub>1</sub>	e	F	H	H <sub>1</sub>	p	Q	q	U <sub>1</sub>	U <sub>2</sub>	w <sub>1</sub>	w <sub>2</sub>	w <sub>3</sub>
mm	6.81 6.07	2.15 1.85	3.20 2.89	0.16 0.07	9.25 9.04	9.30 8.99	5.95 5.74	6.00 5.70	3.58	3.05 2.54	11.31 10.54	9.27 9.01	3.43 3.17	4.32 4.11	18.42	24.90 24.63	6.00 5.70	0.51	1.02	0.26
inches	0.268 0.239	0.085 0.073	0.126 0.114	0.006 0.003	0.364 0.356	0.366 0.354	0.234 0.226	0.236 0.224	0.140	0.120 0.100	0.445 0.415	0.365 0.355	0.135 0.125	0.170 0.162	0.725	0.980 0.970	0.236 0.224	0.02	0.04	0.01

OUTLINE VERSION	REFERENCES				EUROPEAN PROJECTION	ISSUE DATE
	IEC	JEDEC	EIAJ			
SOT171A						97-06-28

---

**UHF power transistor****BLV920**

---

**DEFINITIONS**

<b>Data Sheet Status</b>	
Objective specification	This data sheet contains target or goal specifications for product development.
Preliminary specification	This data sheet contains preliminary data; supplementary data may be published later.
Product specification	This data sheet contains final product specifications.
<b>Limiting values</b>	
Limiting values given are in accordance with the Absolute Maximum Rating System (IEC 134). Stress above one or more of the limiting values may cause permanent damage to the device. These are stress ratings only and operation of the device at these or at any other conditions above those given in the Characteristics sections of the specification is not implied. Exposure to limiting values for extended periods may affect device reliability.	
<b>Application information</b>	
Where application information is given, it is advisory and does not form part of the specification.	

**LIFE SUPPORT APPLICATIONS**

These products are not designed for use in life support appliances, devices, or systems where malfunction of these products can reasonably be expected to result in personal injury. Philips customers using or selling these products for use in such applications do so at their own risk and agree to fully indemnify Philips for any damages resulting from such improper use or sale.

# Philips Semiconductors – a worldwide company

**Argentina:** see South America

**Australia:** 34 Waterloo Road, NORTH RYDE, NSW 2113,  
Tel. +61 2 9805 4455, Fax. +61 2 9805 4466

**Austria:** Computerstr. 6, A-1101 WIEN, P.O. Box 213, Tel. +43 160 1010,  
Fax. +43 160 101 1210

**Belarus:** Hotel Minsk Business Center, Bld. 3, r. 1211, Volodarski Str. 6,  
220050 MINSK, Tel. +375 172 200 733, Fax. +375 172 200 773

**Belgium:** see The Netherlands

**Brazil:** see South America

**Bulgaria:** Philips Bulgaria Ltd., Energoproject, 15th floor,  
51 James Bourchier Blvd., 1407 SOFIA,  
Tel. +359 2 689 211, Fax. +359 2 689 102

**Canada:** PHILIPS SEMICONDUCTORS/COMPONENTS,  
Tel. +1 800 234 7381

**China/Hong Kong:** 501 Hong Kong Industrial Technology Centre,  
72 Tat Chee Avenue, Kowloon Tong, HONG KONG,  
Tel. +852 2319 7888, Fax. +852 2319 7700

**Colombia:** see South America

**Czech Republic:** see Austria

**Denmark:** Prags Boulevard 80, PB 1919, DK-2300 COPENHAGEN S,  
Tel. +45 32 88 2636, Fax. +45 31 57 0044

**Finland:** Sinikalliontie 3, FIN-02630 ESPOO,  
Tel. +358 9 615800, Fax. +358 9 61580920

**France:** 51 Rue Carnot, BP317, 92156 SURESNES Cedex,  
Tel. +33 1 40 99 6161, Fax. +33 1 40 99 6427

**Germany:** Hammerbrookstraße 69, D-20097 HAMBURG,  
Tel. +49 40 23 53 60, Fax. +49 40 23 536 300

**Greece:** No. 15, 25th March Street, GR 17778 TAVROS/ATHENS,  
Tel. +30 1 4894 339/239, Fax. +30 1 4814 240

**Hungary:** see Austria

**India:** Philips INDIA Ltd, Band Box Building, 2nd floor,  
254-D, Dr. Annie Besant Road, Worli, MUMBAI 400 025,  
Tel. +91 22 493 8541, Fax. +91 22 493 0966

**Indonesia:** see Singapore

**Ireland:** Newstead, Clonskeagh, DUBLIN 14,  
Tel. +353 1 7640 000, Fax. +353 1 7640 200

**Israel:** RAPAC Electronics, 7 Kehilat Saloniki St, PO Box 18053,  
TEL AVIV 61180, Tel. +972 3 645 0444, Fax. +972 3 649 1007

**Italy:** PHILIPS SEMICONDUCTORS, Piazza IV Novembre 3,  
20124 MILANO, Tel. +39 2 6752 2531, Fax. +39 2 6752 2557

**Japan:** Philips Bldg 13-37, Kohnan 2-chome, Minato-ku, TOKYO 108,  
Tel. +81 3 3740 5130, Fax. +81 3 3740 5077

**Korea:** Philips House, 260-199 Itaewon-dong, Yongsan-ku, SEOUL,  
Tel. +82 2 709 1412, Fax. +82 2 709 1415

**Malaysia:** No. 76 Jalan Universiti, 46200 PETALING JAYA, SELANGOR,  
Tel. +60 3 750 5214, Fax. +60 3 757 4880

**Mexico:** 5900 Gateway East, Suite 200, EL PASO, TEXAS 79905,  
Tel. +9-5 800 234 7381

**Middle East:** see Italy

**Netherlands:** Postbus 90050, 5600 PB EINDHOVEN, Bldg. VB,  
Tel. +31 40 27 82785, Fax. +31 40 27 88399

**New Zealand:** 2 Wagener Place, C.P.O. Box 1041, AUCKLAND,  
Tel. +64 9 849 4160, Fax. +64 9 849 7811

**Norway:** Box 1, Manglerud 0612, OSLO,  
Tel. +47 22 74 8000, Fax. +47 22 74 8341

**Philippines:** Philips Semiconductors Philippines Inc.,  
106 Valero St. Salcedo Village, P.O. Box 2108 MCC, MAKATI,  
Metro MANILA, Tel. +63 2 816 6380, Fax. +63 2 817 3474

**Poland:** Ul. Lukiska 10, PL 04-123 WARSZAWA,  
Tel. +48 22 612 2831, Fax. +48 22 612 2327

**Portugal:** see Spain

**Romania:** see Italy

**Russia:** Philips Russia, Ul. Usatcheva 35A, 119048 MOSCOW,  
Tel. +7 095 755 6918, Fax. +7 095 755 6919

**Singapore:** Lorong 1, Toa Payoh, SINGAPORE 1231,  
Tel. +65 350 2538, Fax. +65 251 6500

**Slovakia:** see Austria

**Slovenia:** see Italy

**South Africa:** S.A. PHILIPS Pty Ltd., 195-215 Main Road Martindale,  
2092 JOHANNESBURG, P.O. Box 7430 Johannesburg 2000,  
Tel. +27 11 470 5911, Fax. +27 11 470 5494

**South America:** Al. Vicente Pinzon, 173, 6th floor,  
04547-130 SÃO PAULO, SP, Brazil,  
Tel. +55 11 821 2333, Fax. +55 11 821 2382

**Spain:** Balmes 22, 08007 BARCELONA,  
Tel. +34 3 301 6312, Fax. +34 3 301 4107

**Sweden:** Kottbygatan 7, Akalla, S-16485 STOCKHOLM,  
Tel. +46 8 632 2000, Fax. +46 8 632 2745

**Switzerland:** Allmendstrasse 140, CH-8027 ZÜRICH,  
Tel. +41 1 488 2686, Fax. +41 1 481 7730

**Taiwan:** Philips Semiconductors, 6F, No. 96, Chien Kuo N. Rd., Sec. 1,  
TAIPEI, Taiwan Tel. +886 2 2134 2865, Fax. +886 2 2134 2874

**Thailand:** PHILIPS ELECTRONICS (THAILAND) Ltd.,  
209/2 Sanpavuth-Bangna Road Prakanong, BANGKOK 10260,  
Tel. +66 2 745 4090, Fax. +66 2 398 0793

**Turkey:** Talatpasa Cad. No. 5, 80640 GÜLTEPE/ISTANBUL,  
Tel. +90 212 279 2770, Fax. +90 212 282 6707

**Ukraine:** PHILIPS UKRAINE, 4 Patrice Lumumba str., Building B, Floor 7,  
252042 KIEV, Tel. +380 44 264 2776, Fax. +380 44 268 0461

**United Kingdom:** Philips Semiconductors Ltd., 276 Bath Road, Hayes,  
MIDDLESEX UB3 5BX, Tel. +44 181 730 5000, Fax. +44 181 754 8421

**United States:** 811 East Arques Avenue, SUNNYVALE, CA 94088-3409,  
Tel. +1 800 234 7381

**Uruguay:** see South America

**Vietnam:** see Singapore

**Yugoslavia:** PHILIPS, Trg N. Pasica 5/v, 11000 BEOGRAD,  
Tel. +381 11 625 344, Fax. +381 11 635 777

**For all other countries apply to:** Philips Semiconductors,  
International Marketing & Sales Communications, Building BE-p,  
P.O. Box 218, 5600 MD EINDHOVEN, The Netherlands, Fax. +31 40 27 24825

**Internet:** <http://www.semiconductors.philips.com>

© Philips Electronics N.V. 1997

SCA56

All rights are reserved. Reproduction in whole or in part is prohibited without the prior written consent of the copyright owner.

The information presented in this document does not form part of any quotation or contract, is believed to be accurate and reliable and may be changed without notice. No liability will be accepted by the publisher for any consequence of its use. Publication thereof does not convey nor imply any license under patent- or other industrial or intellectual property rights.

Printed in The Netherlands

127067/00/02/pp12

Date of release: 1997 Nov 17

Document order number: 9397 750 03093

*Let's make things better.*

**Philips**  
**Semiconductors**

SUNSTAR自动化 <http://www.sensor-ic.com/> TEL: 0755-83376489 FAX: 0755-83376182 E-MAIL: szss20@163.com



**PHILIPS**