



## Complementary Output Hall Effect Latch

## ATS276/277

### ■ Features

- On-chip Hall sensor with two different sensitivity and hysteresis settings for ATS276/277
- 3.5V to 20V operating voltage
- 400mA (avg) output sink current
- Build-in protecting diode only for chip reverse power connecting
- -20°C to 85°C operating temperature
- Low profile 4 pin SIP package

### ■ Applications

- Dual-coil Brush-less DC Motor
- Dual-coil Brush-less DC Fan
- Revolution Counting
- Speed Measurement

### ■ General Description

ATS276/277 are integrated Hall sensors with output drivers, mainly designed for electronic commutation of brush-less DC Fan. This IC internally includes the regulator, protecting diode, Hall plate, amplifier, comparator, and a pair of complementary open-collector outputs (**DO**, **DOB**).

While the magnetic flux density (**B**) is larger than operate point (**Bop**), **DO** will turn on (low), and meanwhile **DOB** will turn off (high). Each output is latched until **B** is lower than release point (**Brp**), and then **DO**、**DOB** transfer each state.

For DC fan application, sometimes need to test power reverse connection condition. Internal diode only protects chip-side but not for coil-side. If necessary, add one external diode to block the reverse current from coil-side.

### ■ Ordering Information

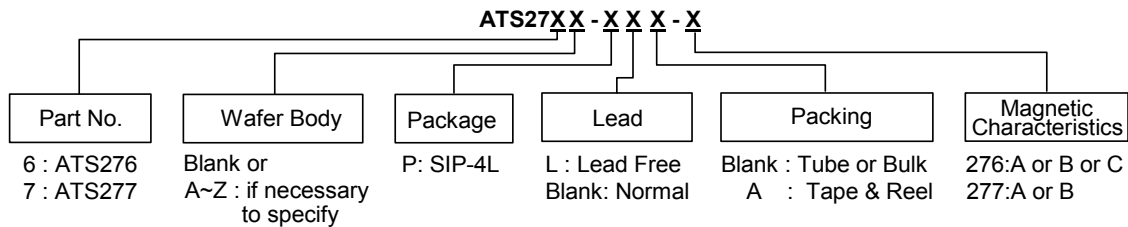

### ■ Typical Application Circuit

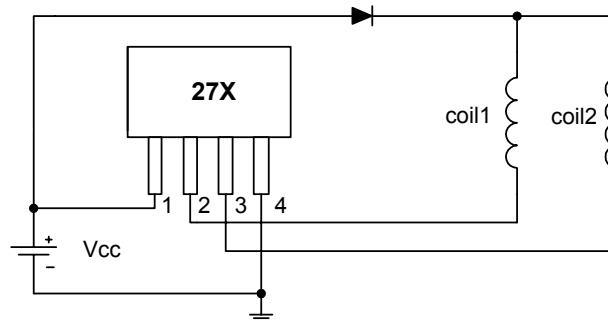

Brush-less DC Fan



Complementary Output Hall Effect Latch

**ATS276/277**

■ **Block Diagram**

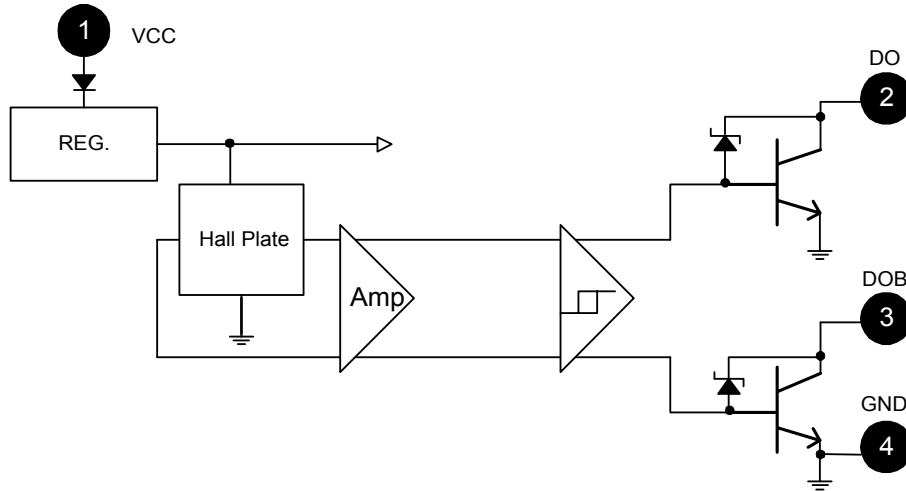

■ **Pin Assignment**

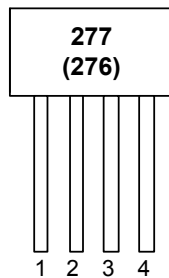

Front View

- 1 : VCC
- 2 : DO
- 3 : DOB
- 4 : GND

Name	P/I/O	Pin #	Description
Vcc	P	1	Power Supply Input
DO	O	2	Output Pin
DOB	O	3	Output Pin
GND	P	4	Ground



Complementary Output Hall Effect Latch

**ATS276/277**

■ **Absolute Maximum Ratings** ( at Ta=25°C )

Characteristics		Symbol	Values	Unit
Supply voltage		V <sub>CC</sub>	20	V
Reverse V <sub>CC</sub> Polarity Voltage		V <sub>RCC</sub>	-20	V
Magnetic flux density		B	Unlimited	
Output "on" current	Continuous	I <sub>c</sub>	0.4	A
	Hold		0.5	
	Peak (Start Up)		0.7	
Operating temperature range		T <sub>a</sub>	-20~+85	°C
Storage temperature range		T <sub>s</sub>	-65~+150	°C
Package Power Dissipation		PD	550	mW
Maximum Junction Temp		T <sub>j</sub>	150	°C

■ **Electrical Characteristics** ( T=+25°C V<sub>cc</sub> = 4.0V to 20V )

Characteristic	Symbol	Conditions	Min	Typ	Max	Units
Low Supply Voltage	V <sub>ce</sub>	V <sub>cc</sub> =3.5V, I <sub>L</sub> =100mA		0.4		V
Supply Voltage	V <sub>cc</sub>		3.5		20	V
Output Zener Breakdown	V <sub>z</sub>			46		V
Output Saturation Voltage	V <sub>ce(sat)</sub>	V <sub>cc</sub> =14V, I <sub>L</sub> =300mA		0.3	0.6	V
Output Leakage Current	I <sub>cex</sub>	V <sub>ce</sub> =14V, V <sub>cc</sub> =14V		<0.1	10	μA
Supply Current	I <sub>cc</sub>	V <sub>cc</sub> =20V, Output Open		16	25	mA
Output Rise Time	t <sub>r</sub>	V <sub>cc</sub> =14V, R <sub>L</sub> =820Ω, C <sub>L</sub> =20pF		3.0	10	μs
Output Falling Time	t <sub>f</sub>	V <sub>cc</sub> =14V, R <sub>L</sub> =820Ω, C <sub>L</sub> =20pF		0.3	1.5	μs
Switch Time Differential	Δt	V <sub>cc</sub> =14V, R <sub>L</sub> =820Ω, C <sub>L</sub> =20pF		3.0	10	μs

■ **Test Circuit**

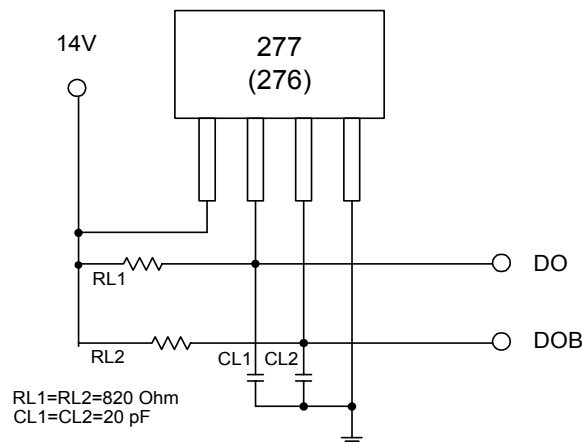



Complementary Output Hall Effect Latch

**ATS276/277**

■ **Magnetic Characteristics( Ta=+25°C)**

(1mT=10 Gauss)

**A grade**

Characteristic		Symbol	Min.	Typ.	Max.	Unit
Operate Point	ATS276	Bop	10	-	50	Gauss
	ATS277		10	-	50	
Release Point	ATS276	Brp	-50	-	-10	Gauss
	ATS277		-50	-	-10	
Hysteresis	ATS276	Bhy	-	75	-	Gauss
	ATS277		-	75	-	

**B grade**

Characteristic		Symbol	Min.	Typ.	Max.	Unit
Operate Point	ATS276	Bop	5	-	70	Gauss
	ATS277		5	-	70	
Release Point	ATS276	Brp	-70	-	-5	Gauss
	ATS277		-70	-	-5	
Hysteresis	ATS276	Bhy	-	75	-	Gauss
	ATS277		-	75	-	

**C grade**

Characteristic		Symbol	Min.	Typ.	Max.	Unit
Operate Point	ATS276	Bop	-	-	100	Gauss
Release Point	ATS276	Brp	-100	-	-	Gauss
Hysteresis	ATS276	Bhy	-	75	-	Gauss

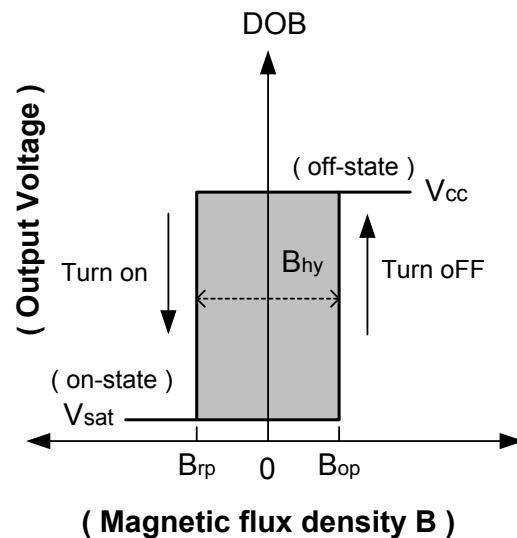
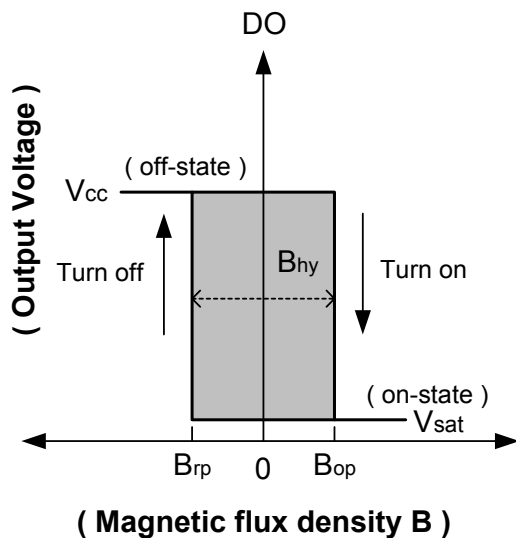



Complementary Output Hall Effect Latch

**ATS276/277**

■ Performance Characteristics (SIP4)

Ta (°C)	25	50	60	70	80	85	90	95	100	105	110	115	120
Pd (mW)	550	440	396	352	308	286	264	242	220	198	176	154	132

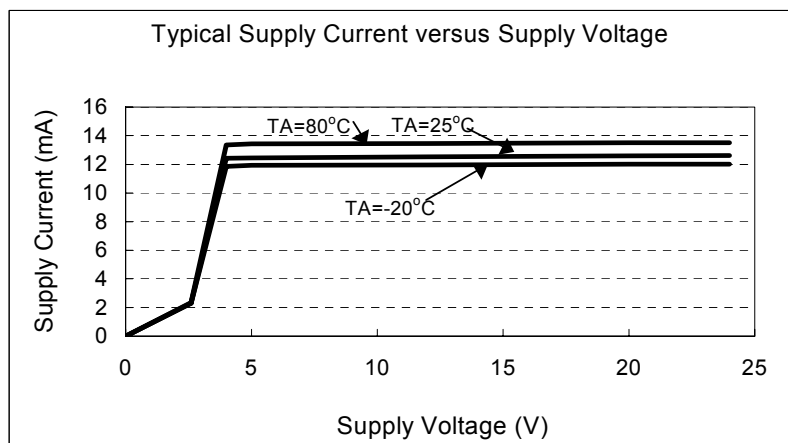
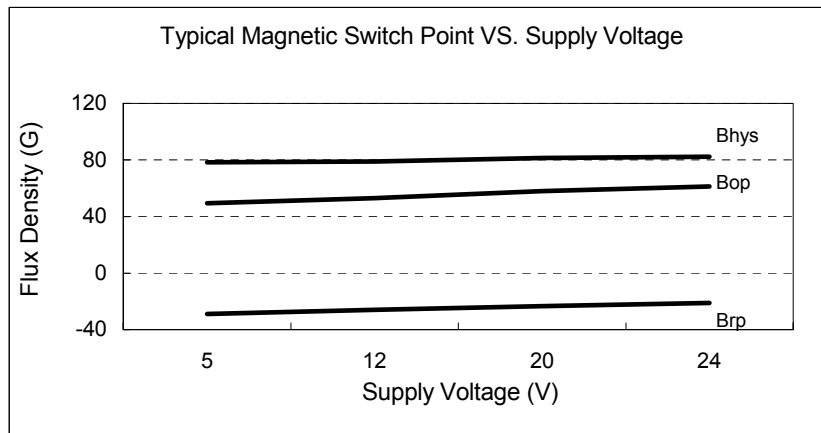
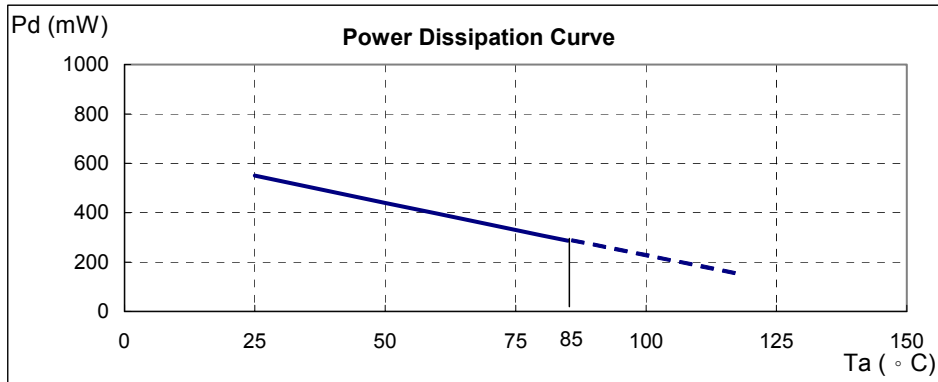



Complementary Output Hall Effect Latch

**ATS276/277**

■ Operating Characteristics

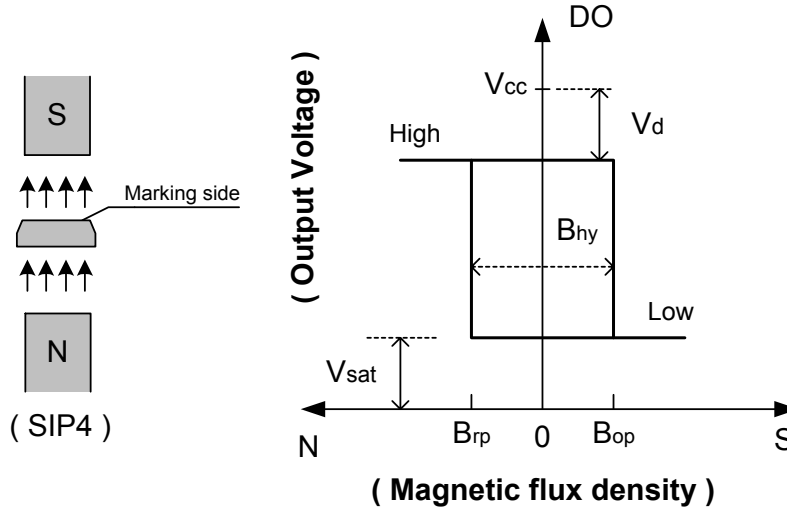

■ Marking Information

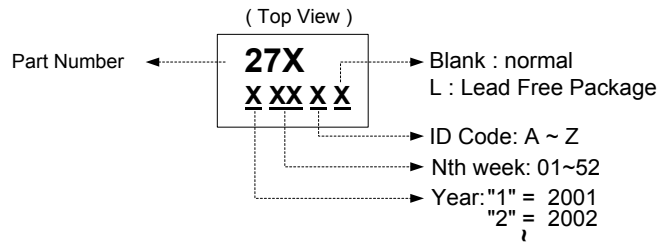



Complementary Output Hall Effect Latch

**ATS276/277**

■ Package Information

Active Area Depth

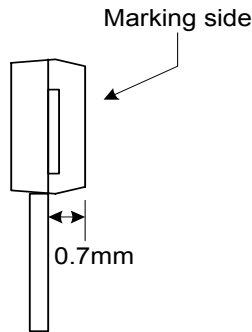

Package Sensor Location

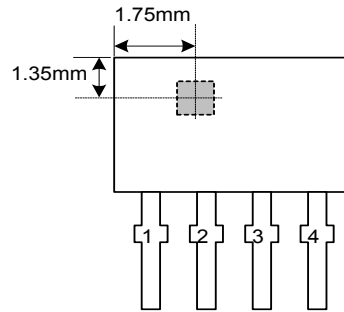

Package Dimension

