

Installation Instructions for the SS49/SS19 Series Analog Position Sensors

ISSUE 2
PK 88740

⚠ WARNING

PERSONAL INJURY

- DO NOT USE these products as safety or emergency stop devices, or in any other application where failure of the product could result in personal injury.

Failure to comply with these instructions could result in death or serious injury.

SS49/SS19 ELECTRICAL CHARACTERISTICS

Supply Voltage	4 to 10 VDC		
Supply Current	4 mA typ.		
Output Type	Analog Sourcing		
Output Voltage @ 0 Gauss, 25°C	1.75 to 2.25 V @ 5 V		
Sensitivity (measured between -400 and +400 gauss), mV/G	Min.	Typ.	Max.
	0.60	0.90	1.25
Operating Temperature	-40 to +100°C (-40 to 212°F)		

ABSOLUTE MAXIMUM RATINGS

Supply Voltage (Vs)	± 12 VDC
Output Current	20 mA
Storage Temperature	-55 to +150°C (-67 to +302°F)
Magnetic Flux	No limit. Circuit cannot be damaged by magnetic overdrive.

NOTICE

Absolute maximum ratings are the extreme limits the device will withstand without damage to the device. However, the electrical and mechanical characteristics are not guaranteed as the maximum limits (above recommended operating conditions) are approached, nor will the device necessarily operate at absolute maximum ratings.

SOLDERING/ASSEMBLY

SS49

Support leads during any forming/shearing operation. Do not stress leads inside plastic case.

Hand soldering - Use 60/40 rosin core solder, and a 399°C (750°F) controlled temperature, 1/8" chisel tip soldering iron. Do not hold iron on terminals for more than four seconds. Lead temperature at package must not exceed 250°C (482°F).

Wave soldering - Use Loncoflux 106A35 or equivalent. Set preheaters at 95°C (200°F) for top (component side) of PC board just prior to entering wave. (This may be adjusted depending upon board thickness.) Set solder temperature at 252°C to 260°C max. (485°F to 500°F). Set conveyor speed to about 4.5 feet per minute (1,37 meter/min.), choosing a speed which gives full solder fillets and minimum bridging and icicles. Provide rigid support for the board.

SS19/SS19T

MICRO SWITCH recommends an infrared reflow process with peak temperatures not to exceed 190 - 200°C (374 - 392°F) for 10 seconds maximum. Keep exposure to high temperatures minimal.

CLEANING

Clean appropriately in accordance with applicable safety procedures. MICRO SWITCH recommends manual cleaning.

BLOCK DIAGRAM

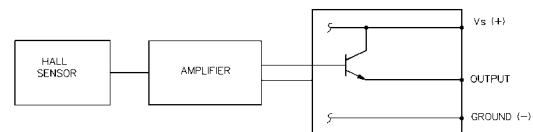

TRANSFER CHARACTERISTICS

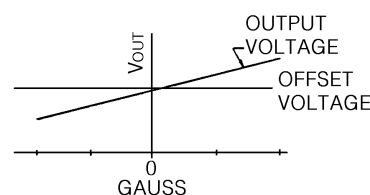

TYPICAL OUTPUT CHARACTERISTICS

GRAPH NO. 1 TYPICAL OUTPUT CHARACTERISTICS AT VARIOUS SUPPLY VOLTAGES

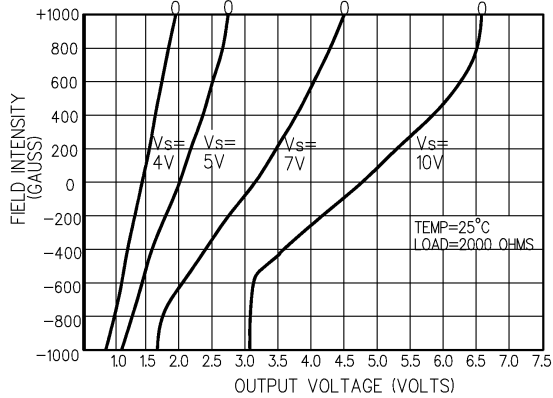

GRAPH NO. 2 TYPICAL OUTPUT CHARACTERISTICS AT VARIOUS TEMPERATURES

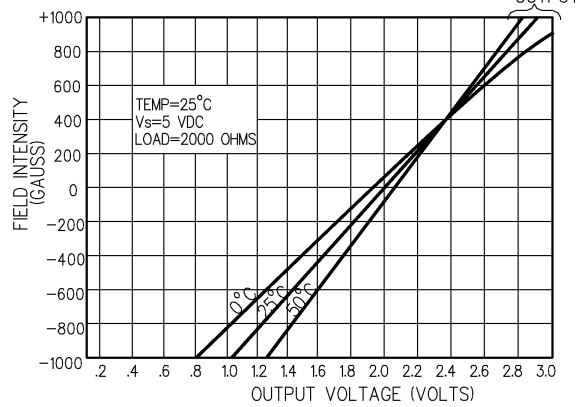

GRAPH NO. 3 TEST LIMITS

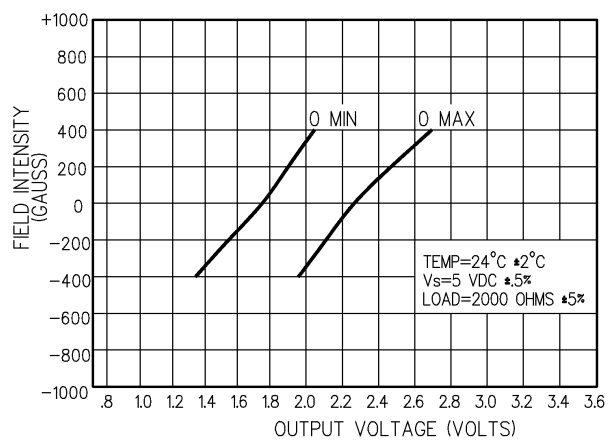

MOUNTING DIMENSIONS (for reference only) SS49 SERIES

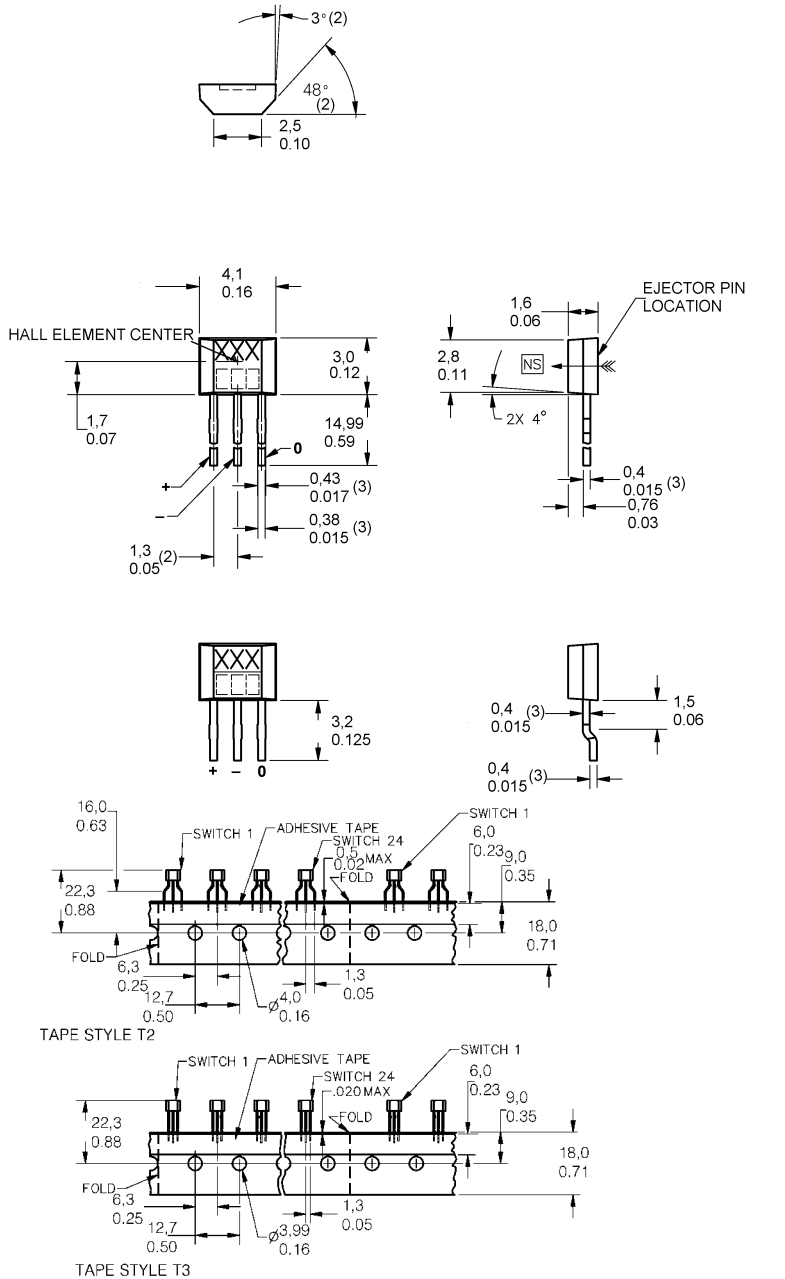

SS19 SERIES

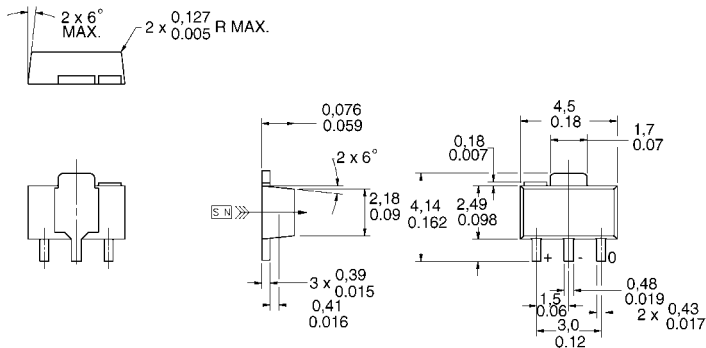

WARRANTY/REMEDY

Honeywell warrants goods of its manufacture as being free of defective materials and faulty workmanship. Contact your local sales office for warranty information. If warranted goods are returned to Honeywell during the period of coverage, Honeywell will repair or replace without charge those items it finds defective. The foregoing is Buyer's sole remedy and is **in lieu of all other warranties, expressed or implied, including those of merchantability and fitness for a particular purpose.**

For application assistance, current specifications, pricing or name of the nearest Authorized Distributor, contact a nearby sales office. Or call:

1-800-537-6945 USA

1-800-737-3360 Canada

1-815-235-6847 International

FAX 1-815-235-6545 USA

INTERNET

<http://www.honeywell.com/sensing/>

info@micro.honeywell.com

Specifications may change without notice. The information we supply is believed to be accurate and reliable as of this printing. However, we assume no responsibility for its use.

While we provide application assistance, personally and through our literature, it is up to the customer to determine the suitability of the product in the application.

Honeywell

MICRO SWITCH

Honeywell Inc.

11 West Spring Street

Freeport, Illinois 61032



Printed with Soy Ink
on 50% Recycled Paper