



**RELATIVE HUMIDITY MODULE**

**HM 1500**

Based on the rugged HS1101 capacitive humidity sensor, HM1500 is a dedicated humidity transducer designed for OEM applications where a reliable and accurate measurement is needed. Direct interface with a micro-controller is made possible with the module's linear voltage output.

**MAIN FEATURES**

- Small size
- Not affected by water immersion
- Full interchangeability
- High reliability and long term stability
- Typical 1 to 4 Volt DC output for 0 to 100 % RH at 5 V DC supply
- Calibrated within +/- 2 % RH @ 55 % RH
- Very low temperature dependence
- Ratiometric to voltage supply within the specified range
- Suitable for 3 to 7 Volts supply voltage



**HUMIDITY SENSOR SPECIFIC FEATURES**

- Instantaneous de-saturation after long periods in saturation phase.
- Patented solid polymer structure.
- High resistance to chemicals.
- Fast response time.



**MAXIMUM RATINGS**

Ratings	Symbol	Value	Unit
Storage Temperature	T <sub>stg</sub>	-30 to 70	°C
Supply Voltage (Peak)	V <sub>s</sub>	7	Vdc
Humidity Operating Range	RH	0 to 100	% RH
Temperature Operating Range	T <sub>a</sub>	-30 to 60	°C

Peak conditions : less than 10% of the operational time.

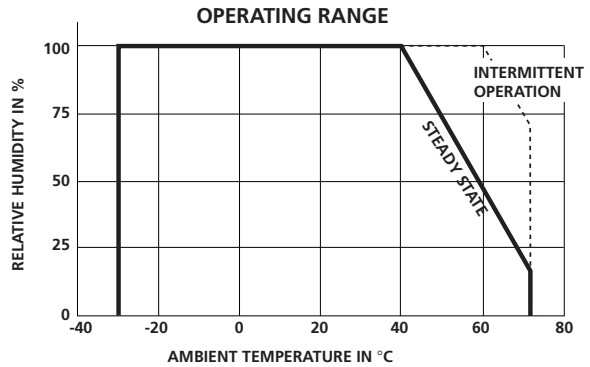

**CHARACTERISTICS**

(T<sub>a</sub> = 23°C, V<sub>s</sub> = 5Vdc, R<sub>L</sub> > 1MΩ otherwise stated)

Characteristics	Symbol	Min.	Typ.	Max.	Unit.
Humidity measuring range	RH	1		99	% RH
Relative Humidity accuracy (10 to 95 % RH)	RH		+/- 3	+/- 5	% RH
Voltage supply	V <sub>s</sub>	4.75	5.00	5.25	V
Nominal output @ RH = 55 %	V <sub>out</sub>	2.42	2.48	2.54	V
Current consumption	I <sub>c</sub>		0.4	0.8	mA
Temperature coefficient (10 to 50 °C)	T <sub>cc</sub>		+ 0.1		% RH/°C
Averaged Sensitivity from 33% to 75% RH	ΔmV /% RH		+ 25		mV /% RH
Sink current capability (R <sub>L</sub> = 15 kΩ)	I <sub>s</sub>			300	μA
Recovery time after 150 hours of condensation	t		10		s
Humidity Hysteresis			+/-1.5		% RH
Long term stability			0.5		% RH/yr
Response time (33 to 76 % RH, static, @ 63 %)	τ		10		s
Output impedance	Z		70		Ω



## MEASUREMENT CONDITIONS

- HM1500 is specified for accurate measurements within 10 to 95% RH.
- Excursion out of this range (< 10% or > 95% RH, including condensation) does not affect the reliability of HM1500 characteristics.
- Dedicated HM15XX Product are available for extreme RH conditions (as HM1520 for low dewpoints) Consult HUMIREL for further information.

HM 1500 Typical Measuring Ranges in Humidity

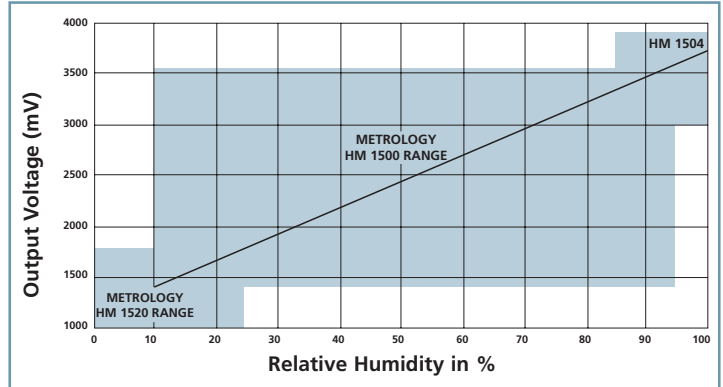

## HM1500 MODELLED LINEAR VOLTAGE OUTPUT (Vs = 5V)

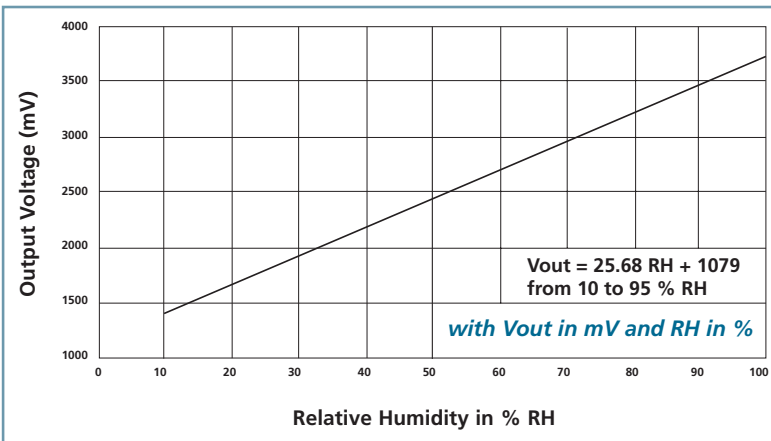

REFERENCE OUTPUT VALUES

RH (%)	V <sub>out</sub> (mV)	RH (%)	V <sub>out</sub> (mV)
10	1325	55	2480
15	1465	60	2605
20	1600	65	2730
25	1735	70	2860
30	1860	75	2990
35	1990	80	3125
40	2110	85	3260
45	2235	90	3405
50	2360	95	3555

### Reversed Polynomial Equation

$$V_{out} = 9E^{-4}RH^3 - 1.3E^{-1}RH^2 + 30.815RH + 1030$$

## ERROR BUDGET AT 23°C

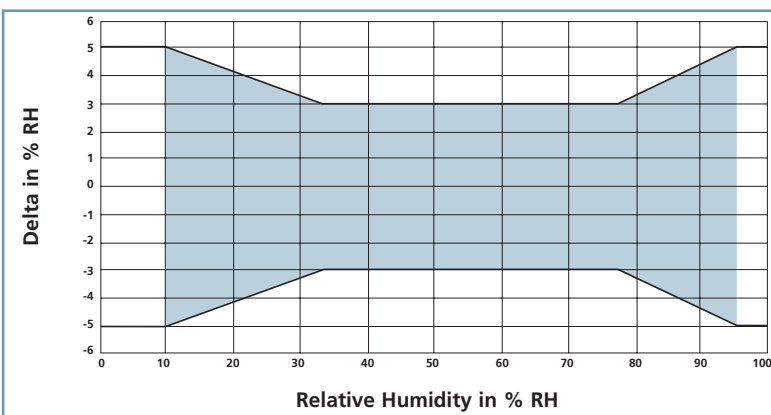

### HM1500 ERROR LIMITS

### Temperature coefficient compensation

$$RH_{Cor}\% = RH\%_{Read} * (1 - (Ta - 23) * 2.4E^{-3})$$

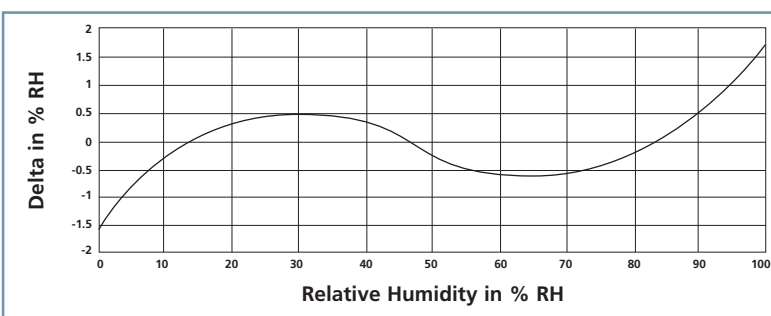

### Non linearity and temperature compensation

$$RH\% = \frac{-1.919E^{-9}V_{out}^3 + 1.335E^{-5}V_{out}^2 + 9.607E^{-3}V_{out} - 21.75}{1 + (Ta-23) * 2.4E^{-3}}$$

All equations V<sub>out</sub> in mV, RH in %, Ta in °C.

### LINEARITY ERROR OF HM1500 MODULE



## HUMIDITY MEASUREMENT USING HM1500

Typical HM 1500 relative Humidity measurement

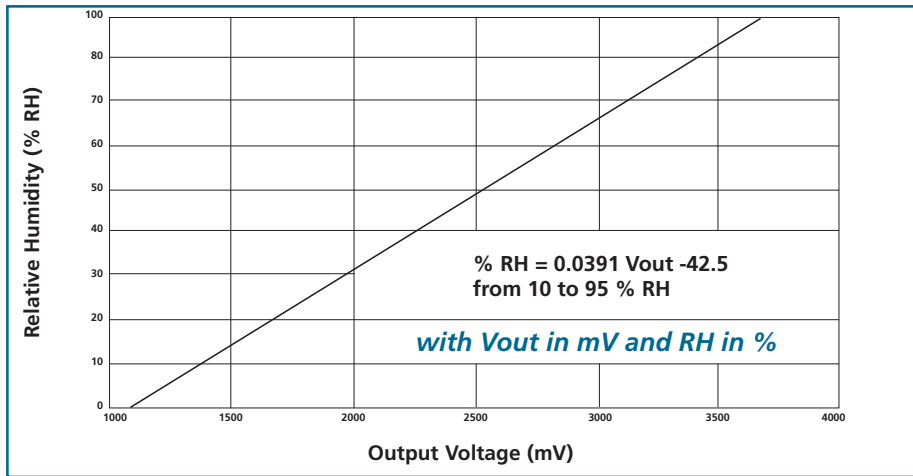

### Internal block diagram of HM1500

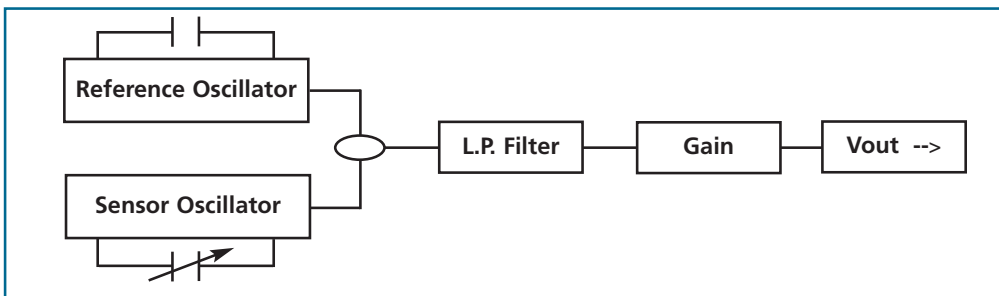

### Suggested applications for HM1500

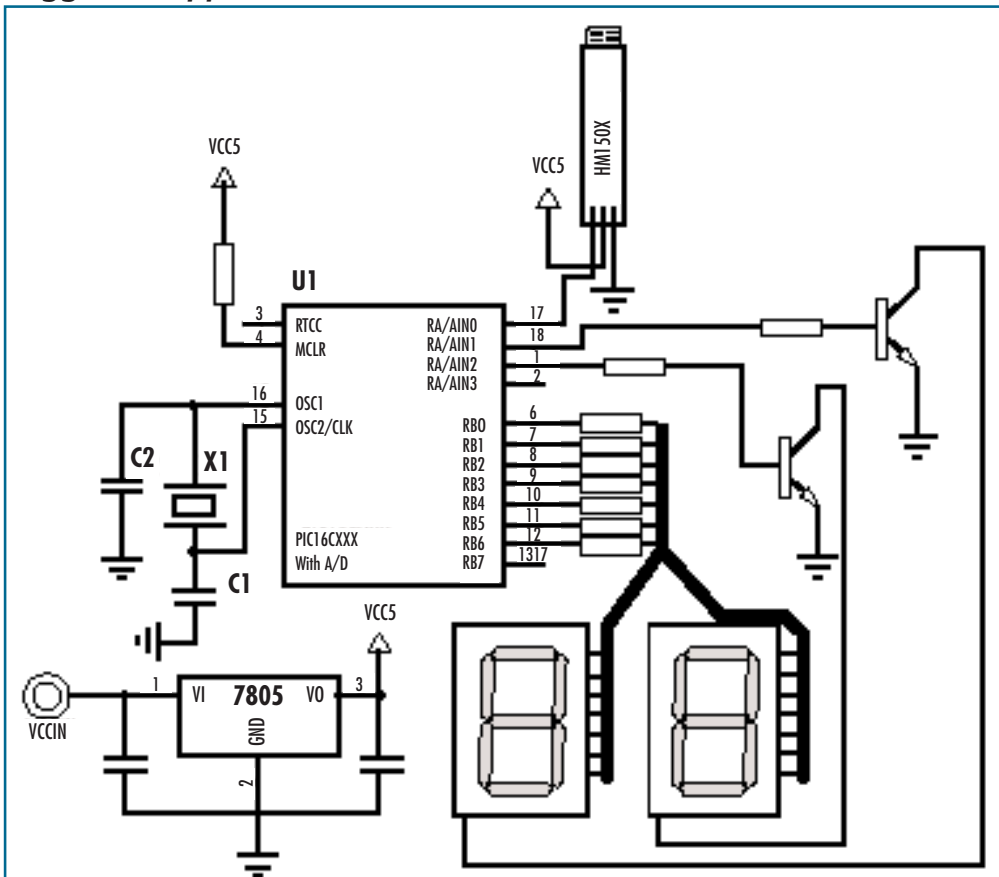

Steps of 1% RH are achievable by using 8-bit A/D.  
If more resolution is required a 10-bit A/D needs to be used and a third display will be added, giving steps of 0.2% RH

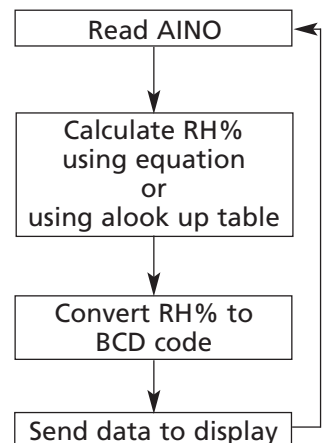

● RESISTANCE TO PHYSICAL AND CHEMICAL STRESSES

- HM1500 has passed through qualification processes of HUMIREL including vibration, shock, storage, high temperature and humidity, ESD.
- Additional tests under harsh chemical conditions demonstrate good operation in presence of salt atmosphere, SO<sub>2</sub> (0.5%), H<sub>2</sub>S (0.5%), O<sub>3</sub>, NO<sub>x</sub>, NO, CO, CO<sub>2</sub>, Softener, Soap, Toluene, acids (H<sub>2</sub>SO<sub>4</sub>, HNO<sub>3</sub>, HCl), HMDS, Insecticide, Cigarette smoke, a non exhaustive list.
- HM1500 is not light sensitive.

● SPECIFIC PRECAUTIONS

- HM1500 is not protected against reversed polarity - Check carefully when connecting the device.
- If you wish to use HM1500 in a chemical atmosphere not listed above, consult us.

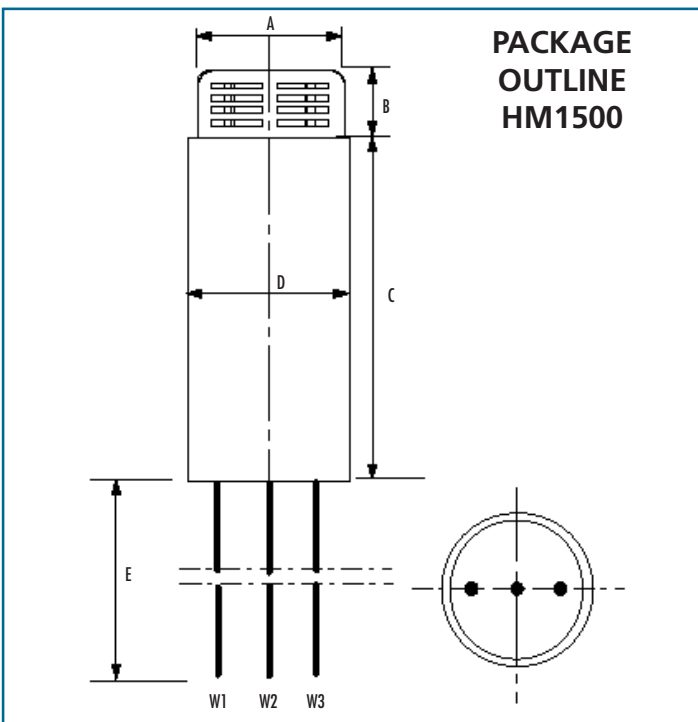

Dim	Min (mm)	Max (mm)
<b>A</b>	9.70	10.20
<b>B</b>	5.00	5.50
<b>C</b>	52	54
<b>D</b>	11.2	11.6
<b>E*</b>	200	250

\* specific length available on request

Wire	Color	Function
<b>W1</b>	White	GROUND
<b>W2</b>	Blue	SUPPLY VOLTAGE
<b>W3</b>	Yellow	OUTPUT VOLTAGE

**ORDERING INFORMATION (MULTIPLE PACKAGE QUANTITY OF 10 PIECES).  
HM1500 : HUMIDITY ANALOG VOLTAGE OUTPUT MODULE.**

**SAMPLE KIT OF HM1500  
IS AVAILABLE THROUGH  
HUMIREL WEB SITE**

**[www.humirel.com](http://www.humirel.com)**

email : [sales@humirel.com](mailto:sales@humirel.com)

The information in this sheet has been carefully reviewed and is believed to be accurate; however, no responsibility is assumed for inaccuracies. Furthermore, this information does not convey to the purchaser of such devices any license under the patent rights to the manufacturer. Humirel reserves the right to make changes without further notice to any product herein. Humirel makes no warranty, representation or guarantee regarding the suitability of its product for any particular purpose, nor does Humirel assume any liability arising out of the application or use of any product or circuit and specifically disclaims any and all liability, including without limitation consequential or incidental damages. « Typical » parameters can and do vary in different applications. All operating parameters, including « Typical » must be validated for each customer applications by customer's technical experts. Humirel does not convey any license under its patent rights nor the rights of others. Humirel products are not designed, intended, or authorized for use as components in systems intended for surgical implant into the body, or other application intended to support or sustain life, or for any application in which the failure of the Humirel product could create a situation where personal injury or death may occur. Should buyer purchase or use Humirel products for any such unintended or unauthorized application, Buyer shall indemnify and hold Humirel and its officers, employees, subsidiaries, affiliates and distributors harmless against all claims, costs, damages and expenses, and reasonable attorney fees arising out of, directly or indirectly, any claim of personal injury or death associated with such unintended or unauthorized use, even if such claim alleges that Humirel was negligent regarding the design or manufacture of the part. Humirel is a registered trade mark of Humirel.

SUNSTAR商斯达实业集团是集研发、生产、工程、销售、代理经销、技术咨询、信息服务等为一体的高科技企业，是专业高科技电子产品生产厂家，是具有10多年历史的专业电子元器件供应商，是中国最早和最大的仓储式连锁规模经营大型综合电子零部件代理分销商之一，是一家专业代理和分销世界各大品牌IC芯片和电子元器件的连锁经营综合性国际公司。在香港、北京、深圳、上海、西安、成都等全国主要电子市场设有直属分公司和产品展示展销窗口门市部专卖店及代理分销商，已在全国范围内建成强大统一的供货和代理分销网络。我们专业代理经销、开发生产电子元器件、集成电路、传感器、微波光电元器件、工控机/DOC/DOM电子盘、专用电路、单片机开发、MCU/DSP/ARM/FPGA软件硬件、二极管、三极管、模块等，是您可靠的一站式现货配套供应商、方案提供商、部件功能模块开发配套商。专业以现代信息产业（计算机、通讯及传感器）三大支柱之一的传感器为主营业务，专业经营各类传感器的代理、销售生产、网络信息、科技图书资料及配套产品设计、工程开发。我们的专业网站——中国传感器科技信息网（全球传感器数据库）[www.SENSOR-IC.COM](http://www.SENSOR-IC.COM) 服务于全球高科技生产商及贸易商，为企业科技产品开发提供技术交流平台。欢迎各厂商互通有无、交换信息、交换链接、发布寻求代理信息。欢迎国外高科技传感器、变送器、执行器、自动控制产品厂商介绍产品到中国，共同开拓市场。本网站是关于各种传感器-变送器-仪器仪表及工业自动化大型专业网站，深入到工业控制、系统工程计 测量、自动化、安防报警、消费电子等众多领域，把最新的传感器-变送器-仪器仪表买卖信息，最新技术供求，最新采购商，行业动态，发展方向，最新的技术应用和市场资讯及时的传递给广大科技开发、科学研究、产品设计人员。本网站已成功为石油、化工、电力、医药、生物、航空、航天、国防、能源、冶金、电子、工业、农业、交通、汽车、矿山、煤炭、纺织、信息、通信、IT、安防、环保、印刷、科研、气象、仪器仪表等领域从事科学研究、产品设计、开发、生产制造的科技人员、管理人员、和采购人员提供满意服务。我们公司专业生产、代理、经销、销售各种传感器、变送器、敏感元器件、开关、执行器、仪器仪表、自动化控制系统：专业从事设计、生产、销售各种传感器、变送器、各种测控仪表、热工仪表、现场控制器、计算机控制系统、数据采集系统、各类环境监控系统、专用控制系统应用软件以及嵌入式系统开发及应用等工作。如热敏电阻、压敏电阻、温度传感器、温度变送器、湿度传感器、湿度变送器、气体传感器、气体变送器、压力传感器、压力变送、称重传感器、物（液）位传感器、物（液）位变送器、流量传感器、流量变送器、电流（压）传感器、溶氧传感器、霍尔传感器、图像传感器、超声波传感器、位移传感器、速度传感器、加速度传感器、扭距传感器、红外传感器、紫外传感器、火焰传感器、激光传感器、振动传感器、轴角传感器、光电传感器、接近传感器、干簧管传感器、继电器传感器、微型电泵、磁敏（阻）传感器、压力开关、接近开关、光电开关、色标传感器、光纤传感器、齿轮测速传感器、时间继电器、计数器、计米器、温控仪、固态继电器、调压模块、电磁铁、电压表、电流表等特殊传感器。同时承接传感器应用电路、产品设计和自动化工程项目。

更多产品请看本公司产品专用销售网站：

商斯达中国传感器科技信息网：<http://www.sensor-ic.com/>

商斯达工控安防网：<http://www.pc-ps.net/>

商斯达电子元器件网：<http://www.sunstare.com/>

商斯达微波光电产品网：[HTTP://www.rfoe.net/](http://www.rfoe.net/)

商斯达消费电子产品网：<http://www.icasic.com/>

商斯达军工产品网：<http://www.junpinic.com/>

商斯达实业科技产品网：<http://www.sunstars.cn/> 传感器销售热线：

地址：深圳市福田区福华路福庆街鸿图大厦1602室

电话：0755-83607652 83376489 83376549 83370250 83370251 82500323

传真：0755-83376182 (0) 13902971329 MSN: [SUNS888@hotmail.com](mailto:SUNS888@hotmail.com)

邮编：518033 E-mail: [szss20@163.com](mailto:szss20@163.com) QQ: 195847376

深圳赛格展销部：深圳华强北路赛格电子市场2583号 电话：0755-83665529 25059422

技术支持：0755-83394033 13501568376

欢迎索取免费详细资料、设计指南和光盘；产品凡多，未能尽录，欢迎来电查询。

北京分公司：北京海淀区知春路132号中发电子大厦3097号

TEL: 010-81159046 82615020 13501189838 FAX: 010-62543996

上海分公司：上海市北京东路668号上海赛格电子市场D125号

TEL: 021-28311762 56703037 13701955389 FAX: 021-56703037

西安分公司：西安高新开发区20所(中国电子科技集团导航技术研究所)

西安劳动南路88号电子商城二楼D23号

TEL: 029-81022619 13072977981 FAX: 029-88789382