

OKI electronic components

OCM1□4, 1□5 SERIES

Low Output-capacitance Type Optical MOS Relay For DC Load Only

GENERAL DESCRIPTION

The OCM1□4 and OCM1□5 Series are optical MOS relays for DC load only that provide high-speed response and are capable of handling high-frequency signals. The input portion is an infrared light emitting diode. The output portion uses a combination of low-capacitance VD-MOS (Vertical Diffusion MOS) FETs and photodiode arrays. The device is encased in an extremely small 6-pin plastic DIP or SMD-type (gull-wing) package.

The optical MOS relay switch may be used in applications that currently use mechanical relay switches, but offers smaller size, noise-free switching, and electronic circuit compatibility because of its non-mechanical operation. Optical MOS relay switches also dissipate less power than equivalent bipolar devices at lower switching frequencies.

FEATURES

- Infinitesimally small control voltage
- Excellent high-frequency characteristics (>30 dB isolation at 10 MHz)
- High-speed response (t_{ON} and t_{OFF} is 200 μ s or less)
- Low leak current
- No chattering or switch bounces
- No mechanical switching noises
- Small size and easy mounting (6-Pin plastic DIP or SMD-type [gull-wing] package)

APPLICATIONS

- Measurement equipment
- Audio-visual equipment
- Home electronics
- Automatic meter reading equipment
- Other applications requiring small size or high performance
- Other applications requiring non-contact switches

PIN CONFIGURATION

(Unit: mm)

• DIP Type

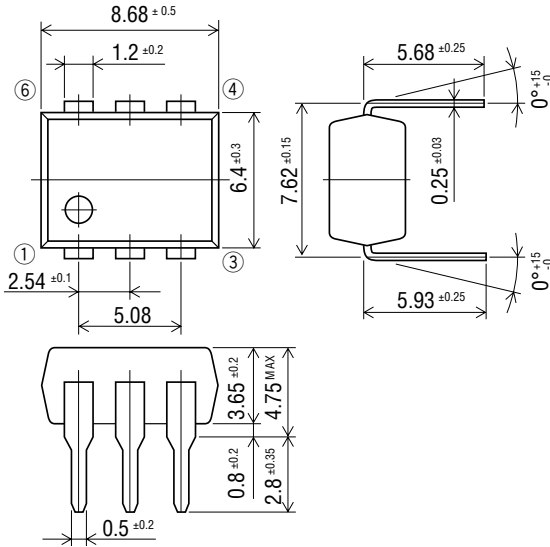

• SMD Type (gull-wing)

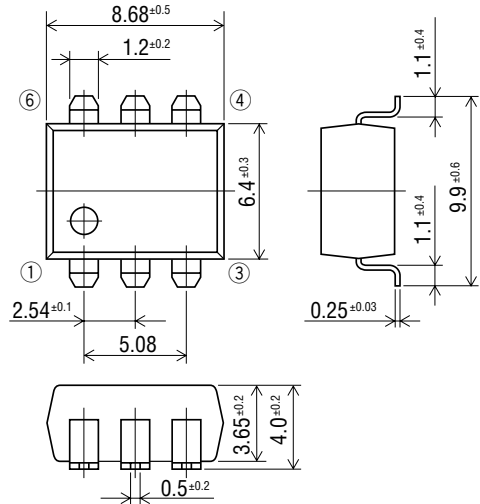

• Through hole (Bottom view)

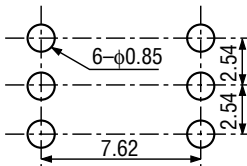

• Mounting pad (Top view)

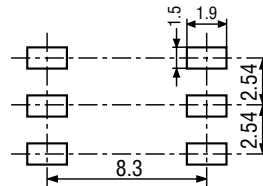

• Pin Connection Diagram

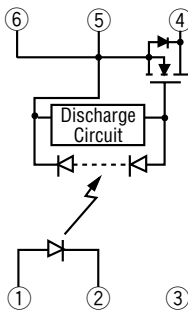

- 1: Anode (LED)
- 2: Cathode (LED)
- 3: NC
- 4: Drain (MOS FET)
- 5: Source (MOS FET)
- 6: Source (MOS FET)

ABSOLUTE MAXIMUM RATINGS

(Ambient temperature Ta=25°C)

Product Name				OCM104	OCM114	OCM124	OCM144	
Parameter	Symbol	Condition	Unit	OCM105	OCM115	OCM125	OCM145	
Input Characteristics	Continuous Forward Current	I _F		mA				50
	Derating Factor of Continuous Forward Current	ΔI _F		mA/°C				Refer to [Derating Factor of Continuous Forward Current] of characteristics data
	Peak Forward Current	I _{FM}	Pulse 10 ms Cycle 10 ms	A				0.5
	Reverse Voltage	V _R		V				5
	Power Dissipation	P _{DL}		mW				75
Output Characteristics	Load Voltage	V _{OFF}		V				60 100 200 400
	Load Current	I _{ON}		mA				100 70 50 20
	Derating Factor of Load Current	ΔI _{ON}		mA/°C				Refer to [Derating Factor of Load Current] of characteristics data
	Surge Load Current	I _{SUG}	Pulse width 1 ms 1shot	A		0.1	0.07	0.025
	Power Dissipation	P _D		mW				300
Total Power Dissipation			P _{tot}	mW				325
Isolation Voltage			V _{IO}	V(rms)	1500			OCM104 OCM114 OCM124 OCM144
					4000			OCM105 OCM115 OCM125 OCM145
Operating Temperature			T _{opr}	°C				-40 to +85
Storage Temperature			T _{stg}	°C				-40 to +100

ELECTRICAL CHARACTERISTICS

(Ambient temperature Ta=25°C)

Product Name						OCM104	OCM114	OCM124	OCM144
Parameter	Symbol	Condition		Unit	OCM105	OCM115	OCM125	OCM145	
Input Characteristics	Forward Voltage	V _F	I _F =10 mA	Min.	V	1.0			
				Max.		1.3			
	Reverse Current	I _R	V _R =5 V	Max.	μA	10			
	Input Current *1	I _{FA}	I _{ON} =Rating	Max.	mA	5			
Input Current	I _{FR}	V _{OFF} =Rating I _{ON} =100 μA	Min.	mA	0.2				
Output Characteristics	On-resistance Recovery	R _{ON}	I _F =10 mA I _{ON} =100 mA <small>Time to flow current is within one second</small>	Min.	Ω	10	20	50	150
				Typ.		15	32.5	75	300
				Max.		20	45	100	450
Off-state Leakage Current *2	I _{OFF}	V _{OFF} =Rating	Max.	nA	1.0				
Output Terminal Capacitance	C _{OUT}	V _{OFF} =50 V f=1 MHz	Typ.	pF	7				
Input-to-output Capacitance	C _{IO}	f=1 MHz	Typ.	pF	1.3				
Coupling Characteristics	Turn-on Time	t _{ON}	I _F =10 mA I _{ON} =	Typ.	μs	30			
				Max.		200			
	Turn-off Time	t _{OFF}	OCM104, 105: 10mA OCM114, 115: 10mA OCM124, 125: 4mA OCM144, 145: 1mA	Typ.	μs	60			
Max.	200								

*1 Can correspond to special specification I_{FA}<3.0 mA*2 Can correspond to special specification I_{OFF}<0.1 nA

TYPICAL CHARACTERISTICS

- Derating Factor of Continuous Forward Current

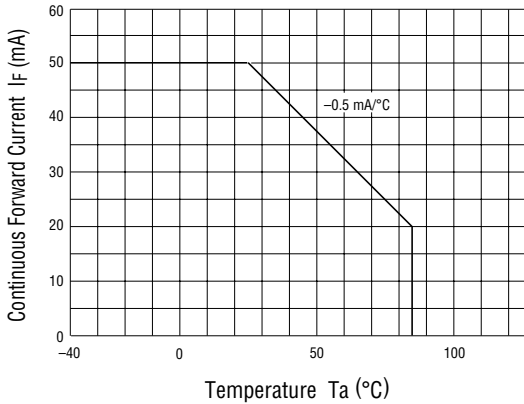

- Derating Factor of Load Current

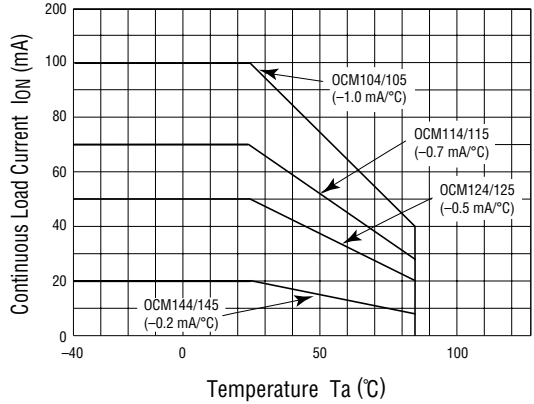

- Operation Input Current vs. Ambient Temperature

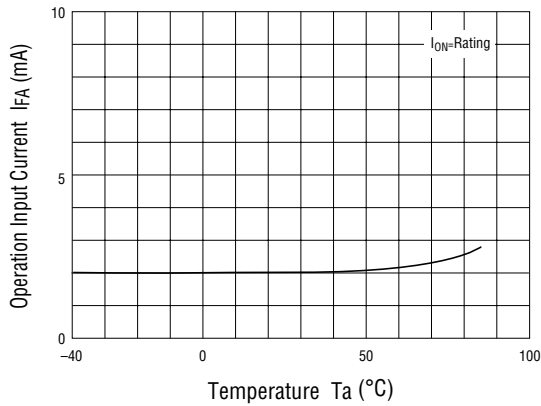

- Recovery Input Current vs. Ambient temperature

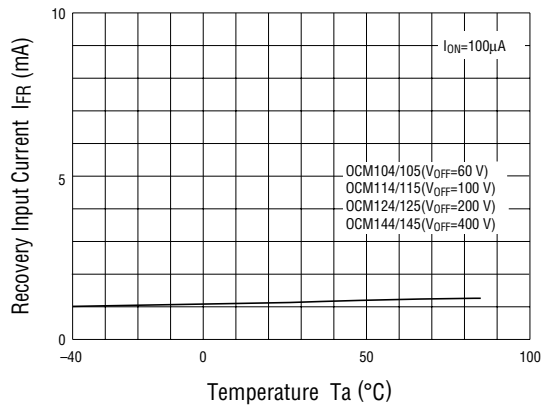

- On-resistance vs. Ambient Temperature 1

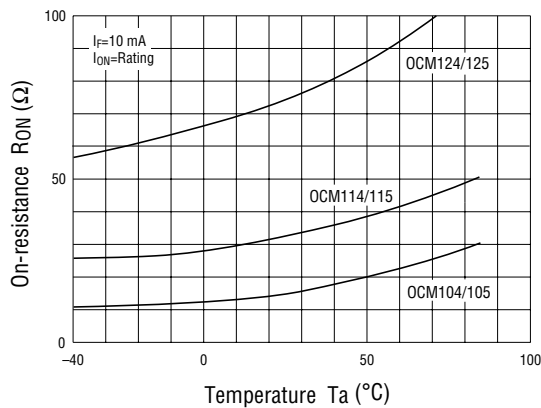

- On-resistance vs. Ambient Temperature 2

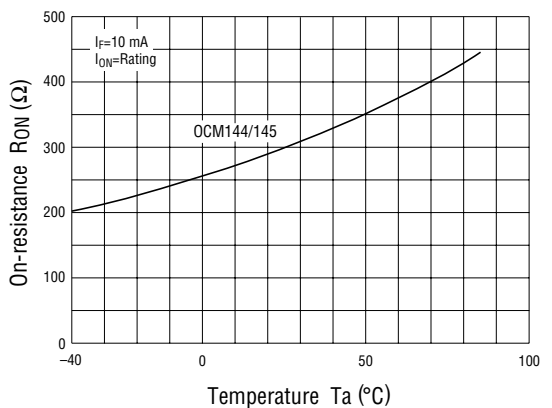

• Turn-on/Turn-off Time vs. Ambient Temperature

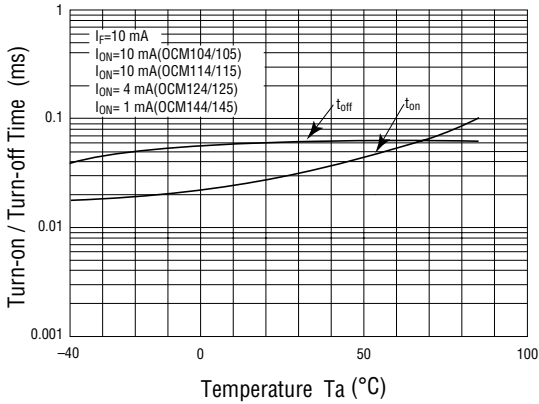

• Off-state Leakage Current vs. Ambient Temperature

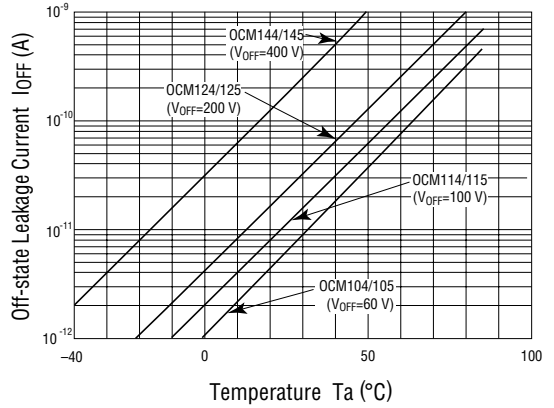

• Continuous Forward Current vs. On-resistance 1

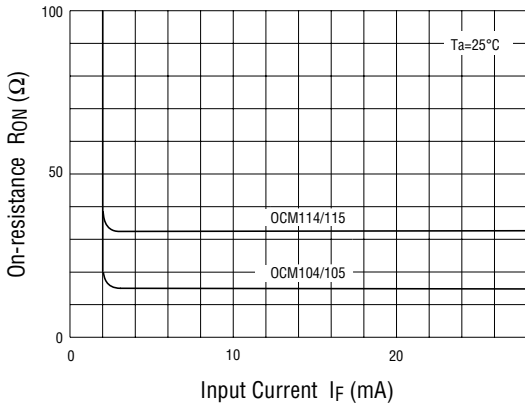

• Continuous Forward Current vs. On-resistance 2

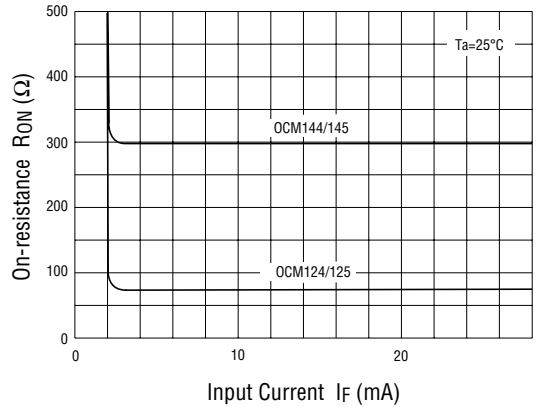

• Continuous Forward Current vs. Turn-on/Turn-off Time

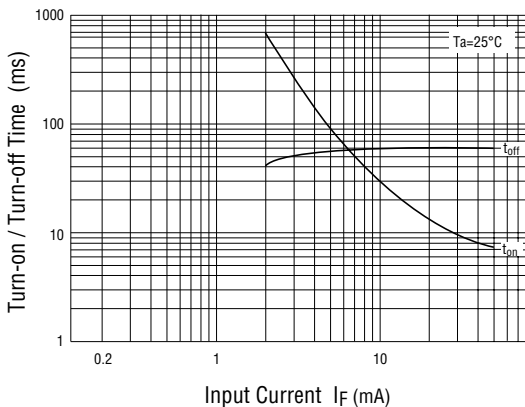

• Output Terminal Capacitance vs. Applied Voltage

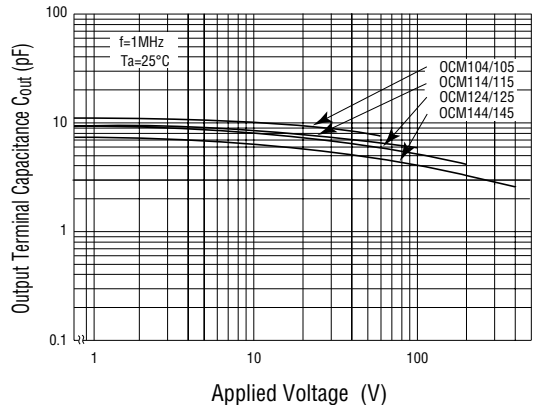

• **Isolation**

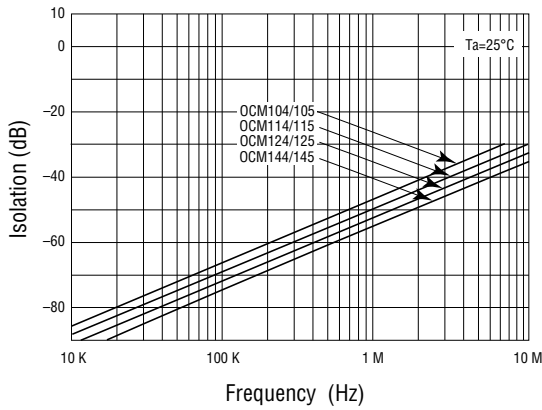

• **Insertion Loss**

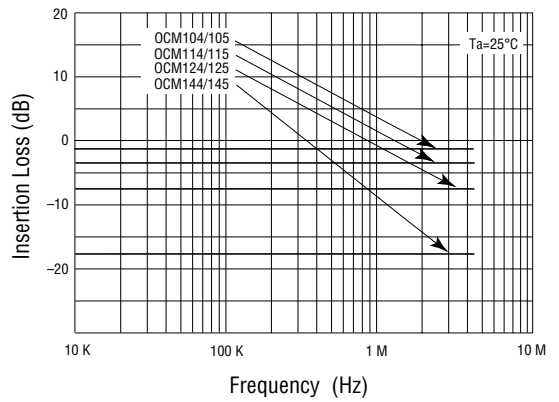

• **Load Current vs. Voltage**

