

MD56V62160/H

4-Bank × 1,048,576-Word × 16-Bit SYNCHRONOUS DYNAMIC RAM

DESCRIPTION

The MD56V62160/H is a 4-bank × 1,048,576-word × 16-bit synchronous dynamic RAM, fabricated in Oki's CMOS silicon-gate process technology. The device operates at 3.3 V. The inputs and outputs are LVTTL compatible.

FEATURES

- Silicon gate, quadruple polysilicon CMOS, 1-transistor memory cell
- 4-bank × 1,048,576-word × 16-bit configuration
- 3.3 V power supply, ±0.3 V tolerance
- Input : LVTTL compatible
- Output : LVTTL compatible
- Refresh : 4096 cycles/64 ms
- Programmable data transfer mode
 - $\overline{\text{CAS}}$ latency (2, 3)
 - Burst length (2, 4, 8)
 - Data scramble (sequential, interleave)
- CBR auto-refresh, Self-refresh capability
- Package:
 - 54-pin 400 mil plastic TSOP (Type II) (TSOPII54-P-400-0.80-K) (Product : MD56V62160/H-xxTA)
 - xx indicates speed rank.

PRODUCT FAMILY

Family	Max. Frequency	Access Time (Max.)	
		t _{AC2}	t _{AC3}
MD56V62160-10	100 MHz	9 ns	9 ns
MD56V62160-12	83 MHz	14 ns	10 ns
MD56V62160H-15	66 MHz	9 ns	9 ns

PIN CONFIGURATION (TOP VIEW)

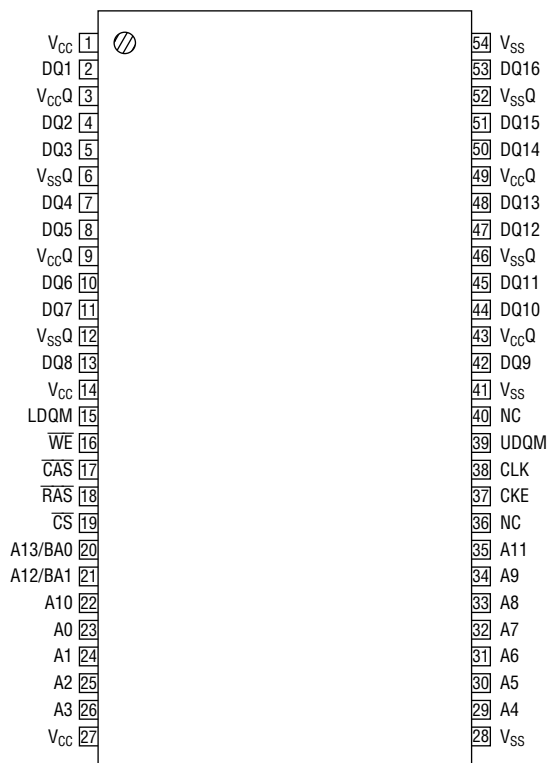
54-Pin Plastic TSOP (II)
(K Type)

Pin Name	Function	Pin Name	Function
CLK	System Clock	UDQM, LDQM	Data Input/Output Mask
$\overline{\text{CS}}$	Chip Select	DQi	Data Input/Output
CKE	Clock Enable	V _{CC}	Power Supply (3.3 V)
A0 - A11	Address	V _{SS}	Ground (0 V)
A12, A13	Bank Select Address	V _{CCQ}	Data Output Power Supply (3.3 V)
$\overline{\text{RAS}}$	Row Address Strobe	V _{SSQ}	Data Output Ground (0 V)
$\overline{\text{CAS}}$	Column Address Strobe	NC	No Connection
$\overline{\text{WE}}$	Write Enable		

Note: The same power supply voltage must be provided to every V_{CC} pin and V_{CCQ} pin.
The same GND voltage level must be provided to every V_{SS} pin and V_{SSQ} pin.

PIN DESCRIPTION

CLK	Fetches all inputs at the "H" edge.
\overline{CS}	Disables or enables device operation by asserting or deactivating all inputs except CLK, CKE, UDQM and LDQM.
CKE	Masks system clock to deactivate the subsequent CLK operation. If CKE is deactivated, system clock will be masked so that the subsequent CLK operation is deactivated. CKE should be asserted at least one cycle prior to a new command.
Address	Row & column multiplexed. Row address: RA0 – RA11 Column address: CA0 – CA7
A12, A13 (BA1, BA0)	Bank Access pins. These pins are dedicated to select one of 4 banks.
\overline{RAS} \overline{CAS} \overline{WE}	Functionality depends on the combination. For details, see the function truth table.
UDQM, LDQM	Masks the read data of two clocks later when UDQM and LDQM are set "H" at the "H" edge of the clock signal. Masks the write data of the same clock when UDQM and LDQM are set "H" at the "H" edge of the clock signal. UDQM controls upper byte and LDQM controls lower byte.
DQi	Data inputs/outputs are multiplexed on the same pin.

BLOCK DIAGRAM

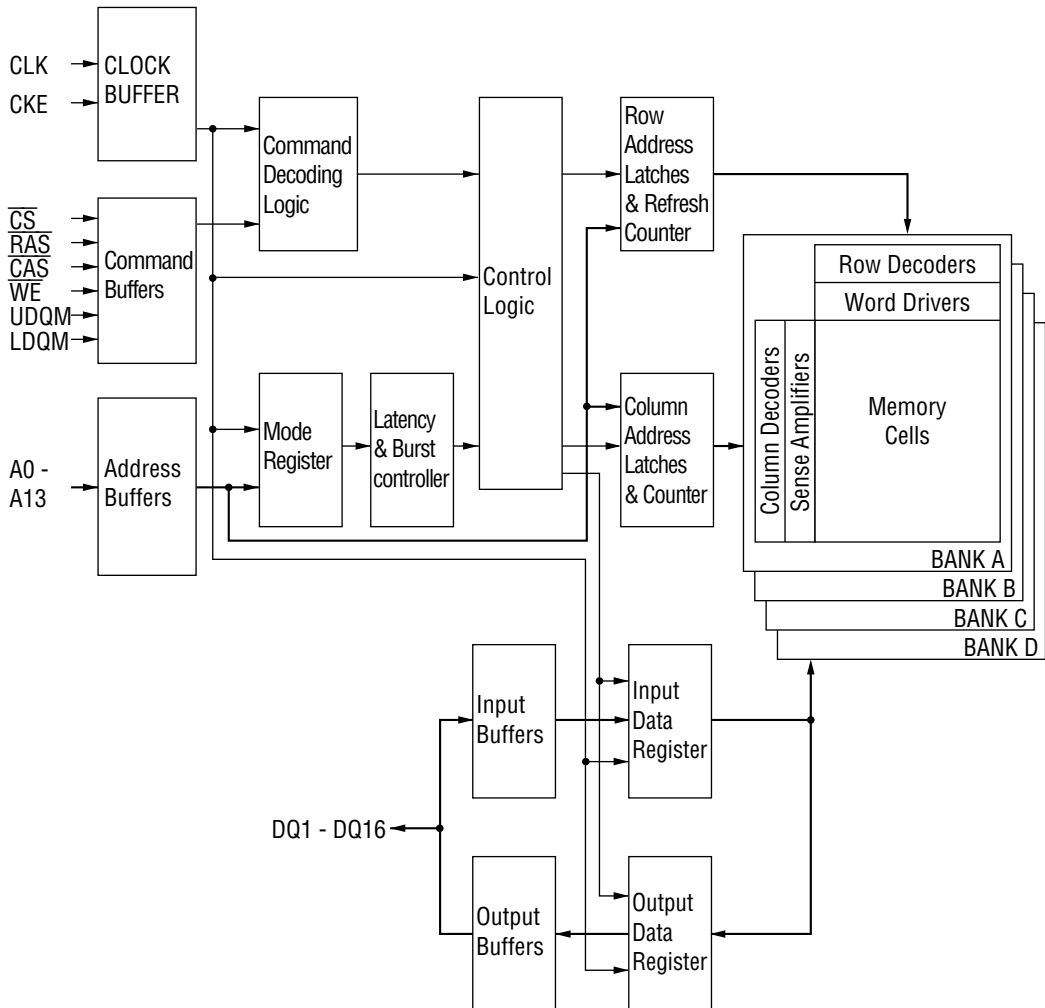

ELECTRICAL CHARACTERISTICS**Absolute Maximum Ratings**(Voltages referenced to V_{SS})

Parameter	Symbol	Rating	Unit
Voltage on Any Pin Relative to V_{SS}	V_{IN}, V_{OUT}	-0.5 to $V_{CC} + 0.5$	V
V_{CC} Supply Voltage	V_{CC}, V_{CCQ}	-0.5 to 4.6	V
Storage Temperature	T_{stg}	-55 to 150	°C
Power Dissipation	P_D^*	1	W
Short Circuit Current	I_{OS}	50	mA
Operating Temperature	T_{opr}	0 to 70	°C

*: $T_a = 25^\circ\text{C}$ **Recommended Operating Conditions**(Voltages referenced to $V_{SS} = 0\text{ V}$)

Parameter	Symbol	Min.	Typ.	Max.	Unit
Power Supply Voltage	V_{CC}, V_{CCQ}	3.0	3.3	3.6	V
Input High Voltage	V_{IH}	2.0	—	$V_{CC} + 0.3$	V
Input Low Voltage	V_{IL}	-0.3	—	0.8	V

Capacitance $(V_{CC} = 3.3\text{ V} \pm 0.3\text{ V}, T_a = 25^\circ\text{C}, f = 1\text{ MHz})$

Parameter	Symbol	Min.	Max.	Unit
Input Capacitance (A0 - A13)	C_{IN1}	2	5	pF
Input Capacitance (CLK, CKE, \overline{CS} , RAS, \overline{CAS} , \overline{WE} , UDQM, LDQM)	C_{IN2}	2	5	pF
Input/Output Capacitance (DQ1 - DQ16)	C_{OUT}	2	7	pF

DC Characteristics

Parameter	Symbol	Condition		Version						Unit	Note
		CKE	Others	-10		-12		H-15			
				Min.	Max.	Min.	Max.	Min.	Max.		
Output High Voltage	V _{OH}	—	I _{OH} = -2 mA	2.4	—	2.4	—	2.4	—	V	
Output Low Voltage	V _{OL}	—	I _{OL} = 2 mA	—	0.4	—	0.4	—	0.4	V	
Input Leakage Current	I _{LI}	—	—	-10	10	-10	10	-10	10	μA	
Output Leakage Current	I _{LO}	—	—	-10	10	-10	10	-10	10	μA	
Average Power Supply Current (Operating)	I _{CC1}	CKE ≥ V _{IH}	t _{CC} = min t _{RC} = min No Burst	—	145	—	125	—	120	mA	1, 2
Power Supply Current (Stand by)	I _{CC2}	CKE ≥ V _{IH}	t _{CC} = min	—	40	—	35	—	30	mA	3
Average Power Supply Current (Clock Suspension)	I _{CC3S}	CKE ≤ V _{IL}	t _{CC} = min	—	15	—	15	—	15	mA	2
Average Power Supply Current (Active Stand by)	I _{CC3}	CKE ≥ V _{IH}	t _{CC} = min	—	95	—	85	—	75	mA	3
Power Supply Current (Burst)	I _{CC4}	CKE ≥ V _{IH}	t _{CC} = min	—	210	—	180	—	160	mA	1, 2
Power Supply Current (Auto-Refresh)	I _{CC5}	CKE ≥ V _{IH}	t _{CC} = min t _{RC} = min	—	185	—	155	—	155	mA	2
Average Power Supply Current (Self-Refresh)	I _{CC6}	CKE ≤ V _{IL}	t _{CC} = min	—	2	—	2	—	2	mA	
Average Power Supply Current (Power down)	I _{CC7}	CKE ≤ V _{IL}	t _{CC} = min	—	2	—	2	—	2	mA	

- Notes:
1. Measured with outputs open.
 2. The address and data can be changed once or left unchanged during one cycle.
 3. The address and data can be changed once or left unchanged during two cycles.

Mode Set Address Keys

CAS Latency				Burst Type		Burst Length				
A6	A5	A4	CL	A3	BT	A2	A1	A0	BT = 0	BT = 1
0	0	0	Reserved	0	Sequential	0	0	0	Reserved	Reserved
0	0	1	Reserved	1	Interleave	0	0	1	2	2
0	1	0	2			0	1	0	4	4
0	1	1	3			0	1	1	8	8
1	0	0	Reserved			1	0	0	Reserved	Reserved
1	0	1	Reserved			1	0	1	Reserved	Reserved
1	1	0	Reserved			1	1	0	Reserved	Reserved
1	1	1	Reserved			1	1	1	Reserved	Reserved

Note: A7, A8, A9, A10, A11, A12 and A13 should stay "L" during mode set cycle.

POWER ON SEQUENCE

1. With inputs in NOP state, turn on the power supply and start the system clock.
2. After the V_{CC} voltage has reached the specified level, pause for 200 μ s or more with the input kept in NOP state.
3. Issue the precharge all bank command.
4. Apply a CBR auto-refresh eight or more times.
5. Enter the mode register setting command.

AC Characteristics

Note 1, 2

Parameter	Symbol	MD56V62160-10		MD56V62160-12		MD56V62160H-15		Unit	Note	
		Min.	Max.	Min.	Max.	Min.	Max.			
Clock Cycles Time	CL = 3	t _{CC}	10	—	12	—	15	—	ns	
	CL = 2		15	—	17.5	—	15	—	ns	
Access Time from Clock	CL = 3	t _{AC}	—	9	—	10	—	9	ns	3, 4
	CL = 2		—	9	—	14	—	9	ns	3, 4
Clock "H" Pulse Time	t _{CH}	3	—	3	—	3	—	ns		
Clock "L" Pulse Time	t _{CL}	3	—	3	—	3	—	ns		
Input Setup Time	t _{SI}	3	—	3	—	3	—	ns		
Input Hold Time	t _{HI}	1	—	1.5	—	1	—	ns		
Output Low Impedance Time from Clock	t _{OLZ}	3	—	3	—	3	—	ns		
Output High Impedance Time from Clock	t _{OHZ}	—	8	—	10	—	8	ns		
Output Hold from Clock	t _{OH}	3	—	3	—	3	—	ns	3	
$\overline{\text{RAS}}$ Cycle Time	t _{RC}	90	—	115	—	105	—	ns		
$\overline{\text{RAS}}$ Precharge Time	t _{RP}	30	—	45	—	30	—	ns		
$\overline{\text{RAS}}$ Active Time	t _{RAS}	60	10 ⁵	70	10 ⁵	70	10 ⁵	ns		
$\overline{\text{RAS}}$ to $\overline{\text{CAS}}$ Delay Time	t _{RCD}	30	—	35	—	30	—	ns		
Write Recovery Time	t _{WR}	15	—	24	—	15	—	ns		
$\overline{\text{RAS}}$ to $\overline{\text{RAS}}$ Bank Active Delay Time	t _{RRD}	20	—	24	—	24	—	ns		
Refresh Time	t _{REF}	—	64	—	64	—	64	ms		
Power-down Exit Set-up Time	t _{PDE}	t _{SI} + 1 CLK	—	t _{SI} + 1 CLK	—	t _{SI} + 1 CLK	—	ns		
Input Level Transition Time	t _T	—	3	—	3	—	3	ns		
$\overline{\text{CAS}}$ to $\overline{\text{CAS}}$ Delay Time (Min.)	t _{CCD}	1	—	1	—	1	—	Cycle		
Clock Disable Time from CKE	t _{CKE}	1	—	1	—	1	—	Cycle		
Data Output High Impedance Time from UDQM, LDQM	t _{DOZ}	2	—	2	—	2	—	Cycle		
Data Input Mask Time from UDQM, LDQM	t _{DOD}	0	—	0	—	0	—	Cycle		
Data Input Time from Write Command	t _{DWD}	0	—	0	—	0	—	Cycle		
Data Output High Impedance Time from Precharge Command	t _{ROH}	2	—	2	—	2	—	Cycle		
Active Command Input Time from Mode Register Set Command Input (Min.)	t _{MRD}	3	—	3	—	3	—	Cycle		
Write Command Input Time from Output	t _{OWD}	2	—	2	—	2	—	Cycle		

- Notes :
1. AC measurements assume that $t_T = 1$ ns.
 2. The reference level for timing of input signals is 1.4 V.
 3. Output load.

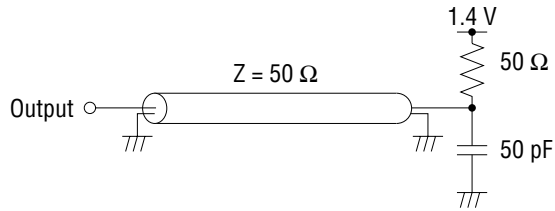

4. The access time is defined at 1.4 V.
5. If t_T is longer than 1 ns, then the reference level for timing of input signals is V_{IH} and V_{IL} .

TIMING WAVEFORM

Read & Write Cycle (Same Bank) @ $\overline{\text{CAS}}$ Latency = 2, Burst Length = 4

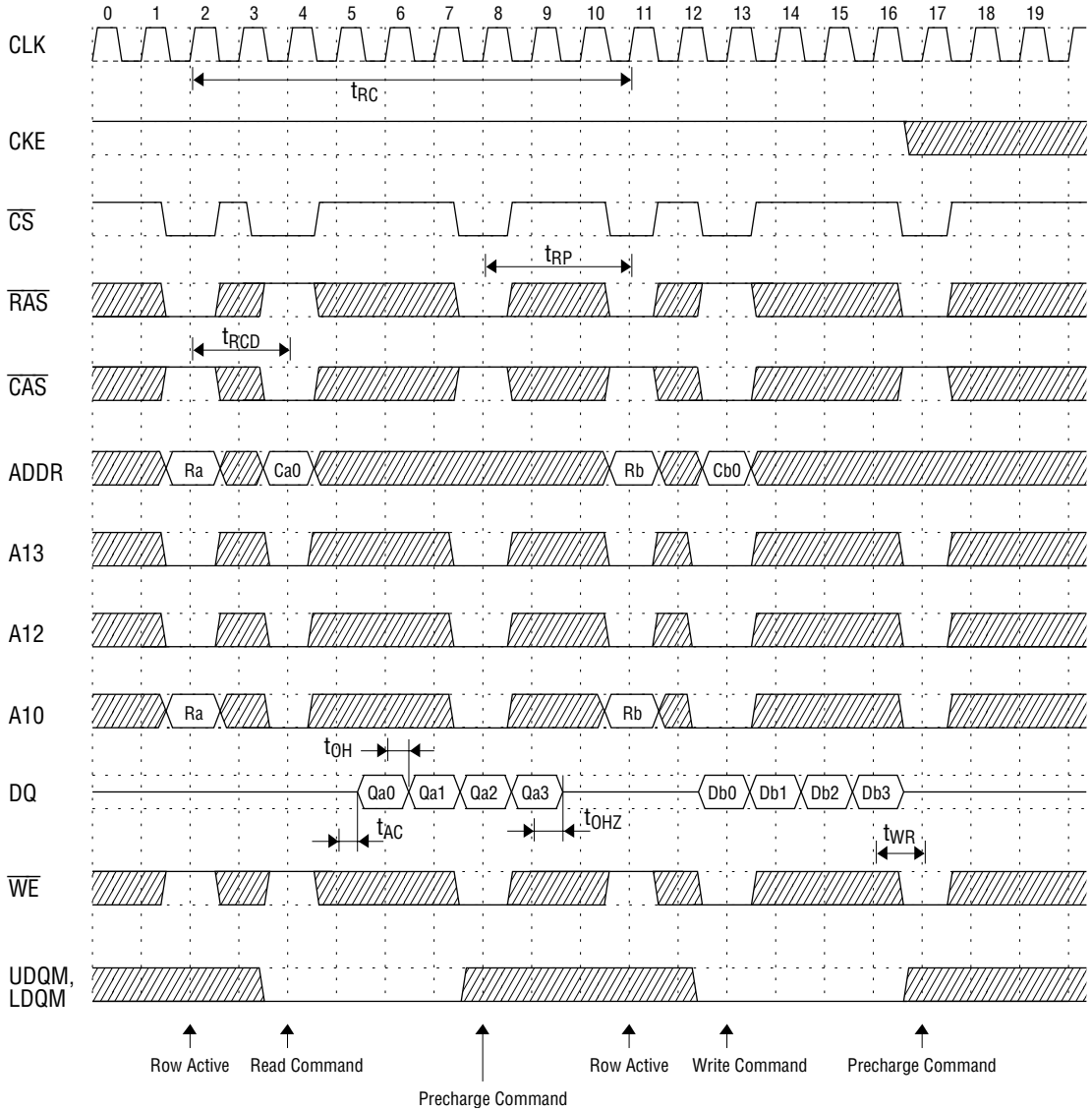

Single Bit Read-Write-Read Cycle (Same Page) @ $\overline{\text{CAS}}$ Latency = 2, Burst Length = 4

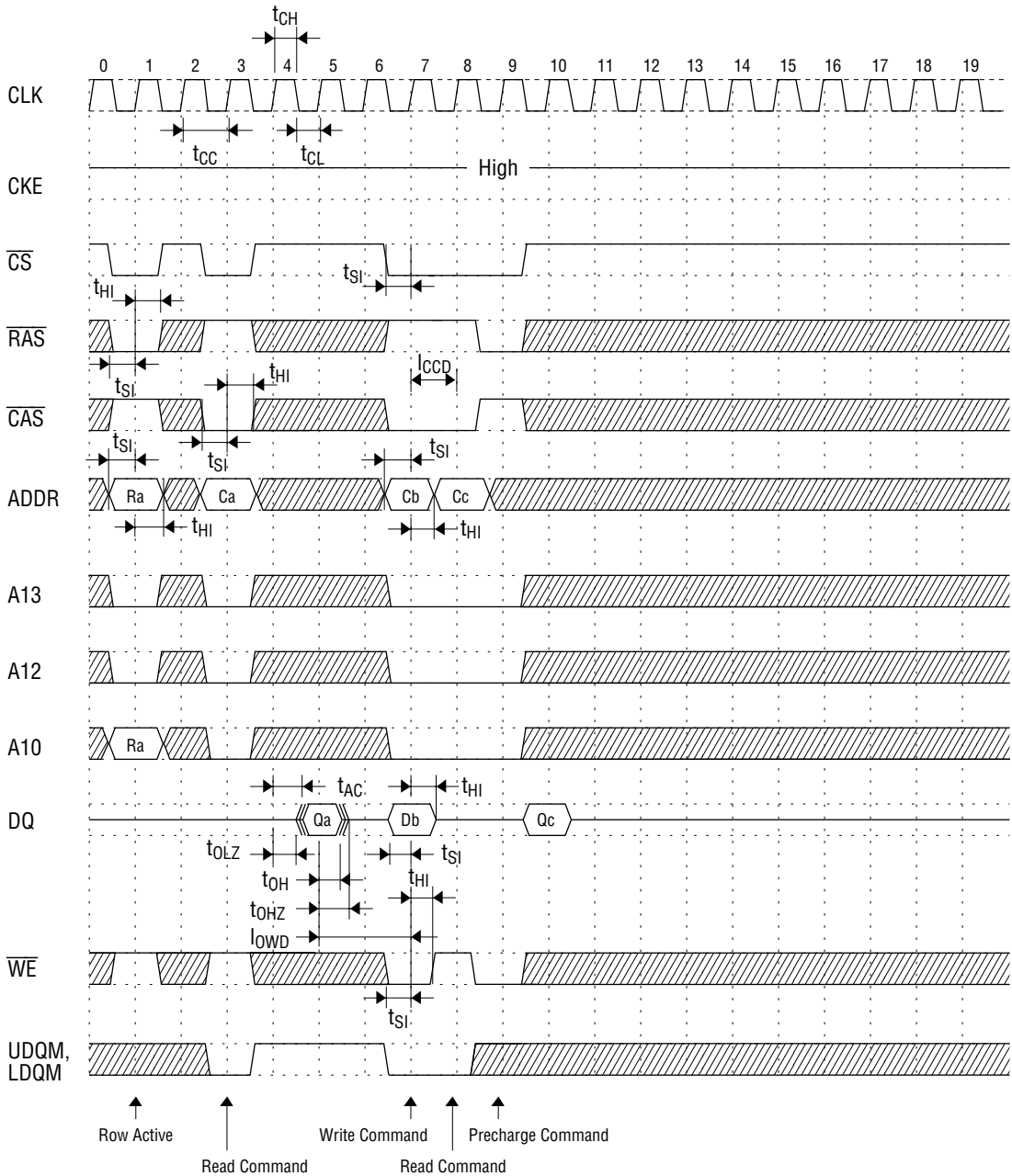

- *Notes:**
1. When \overline{CS} is set "High" at a clock transition from "Low" to "High", all inputs except CKE, UDQM, and LDQM are invalid.
 2. When issuing an active, read or write command, the bank is selected by A12 and A13.

A12	A13	Active, read or write
0	0	Bank A
0	1	Bank B
1	0	Bank C
1	1	Bank D

3. The auto precharge function is enabled or disabled by the A10 input when the read or write command is issued.

A10	A12	A13	Operation
0	0	0	After the end of burst, bank A holds the idle status.
1	0	0	After the end of burst, bank A is precharged automatically.
0	0	1	After the end of burst, bank B holds the idle status.
1	0	1	After the end of burst, bank B is precharged automatically.
0	1	0	After the end of burst, bank C holds the idle status.
1	1	0	After the end of burst, bank C is precharged automatically.
0	1	1	After the end of burst, bank D holds the idle status.
1	1	1	After the end of burst, bank D is precharged automatically.

4. When issuing a precharge command, the bank to be precharged is selected by the A10, A12 and A13 inputs.

A10	A12	A13	Operation
0	0	0	Bank A is precharged.
0	0	1	Bank B is precharged.
0	1	0	Bank C is precharged.
0	1	1	Bank D is precharged.
1	X	X	All banks are precharged.

5. The input data and the write command are latched by the same clock (Write latency = 0).
6. The output is forced to high impedance by $(1 \text{ CLK} + t_{OHZ})$ after UDQM, LDQM entry.

Page Read & Write Cycle (Same Bank) @ $\overline{\text{CAS}}$ Latency = 2, Burst Length = 4

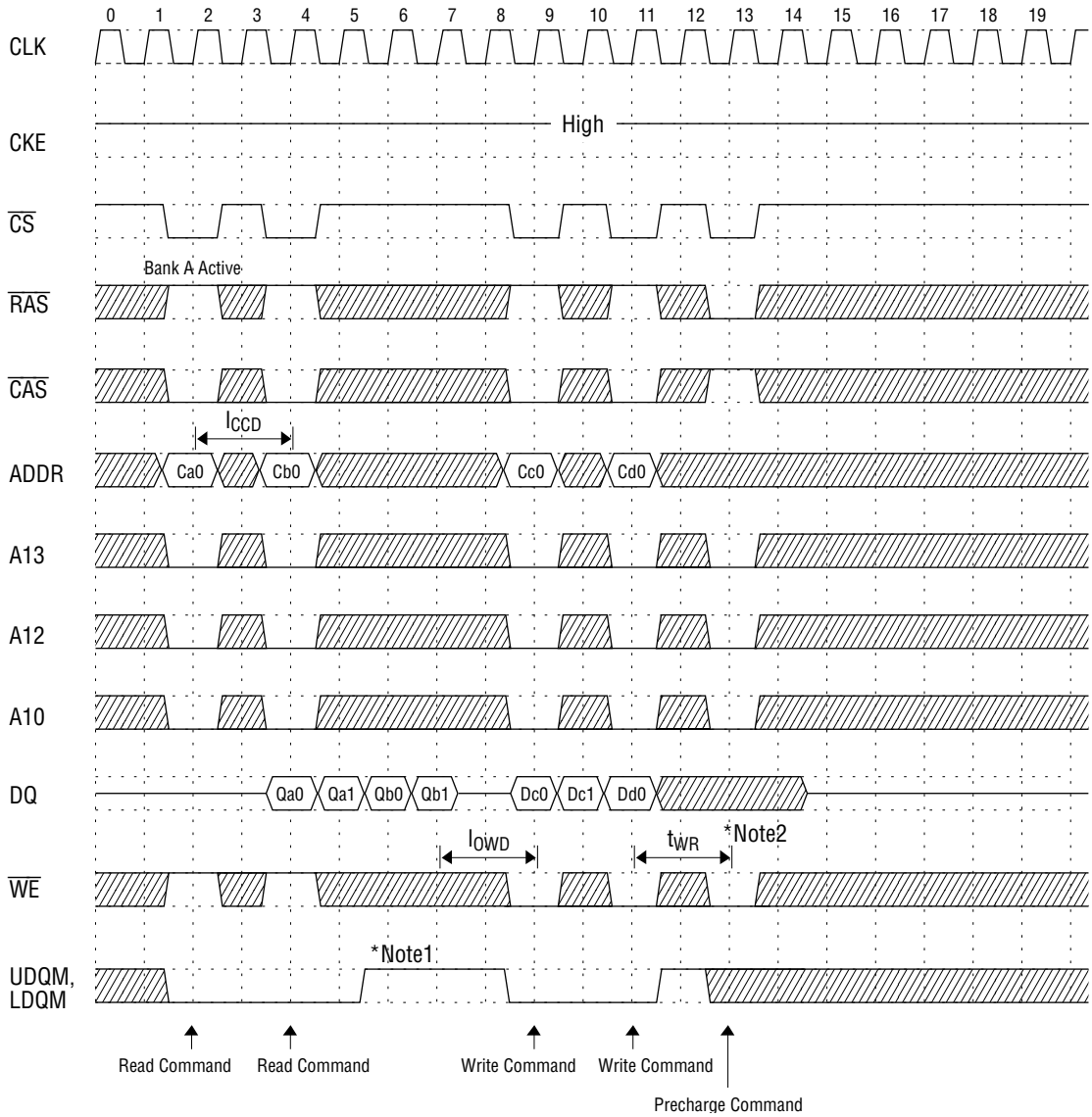

- *Notes:**
1. To write data before a burst read ends, UDQM and LDQM should be asserted three cycles prior to the write command to avoid bus contention.
 2. To assert row precharge before a burst write ends, wait t_{WR} after the last write data input. Input data during the precharge input cycle will be masked internally.

Read & Write Cycle with Auto Precharge @ Burst Length = 4

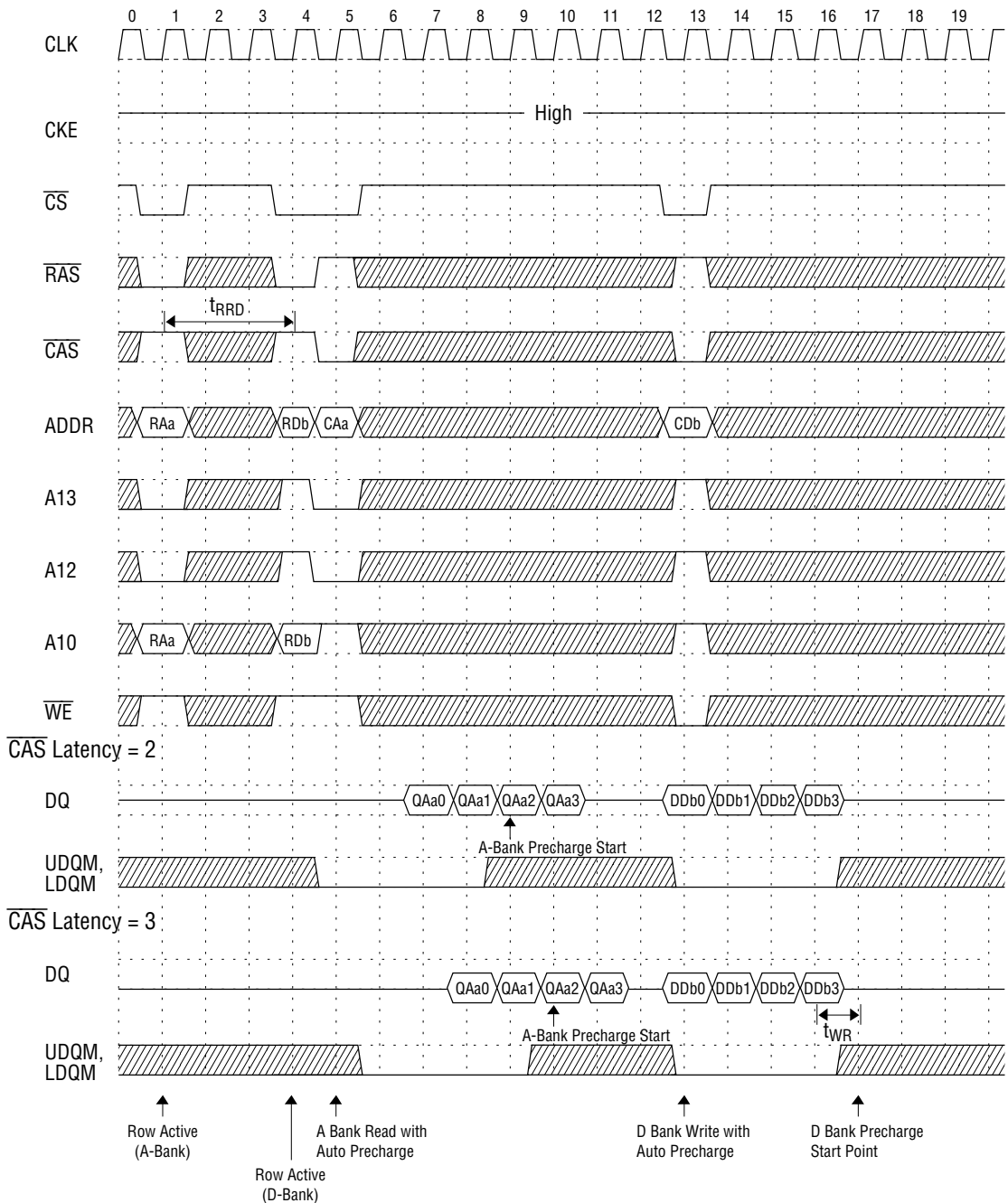

Bank Interleave Random Row Read Cycle @ $\overline{\text{CAS}}$ Latency = 2, Burst Length = 4

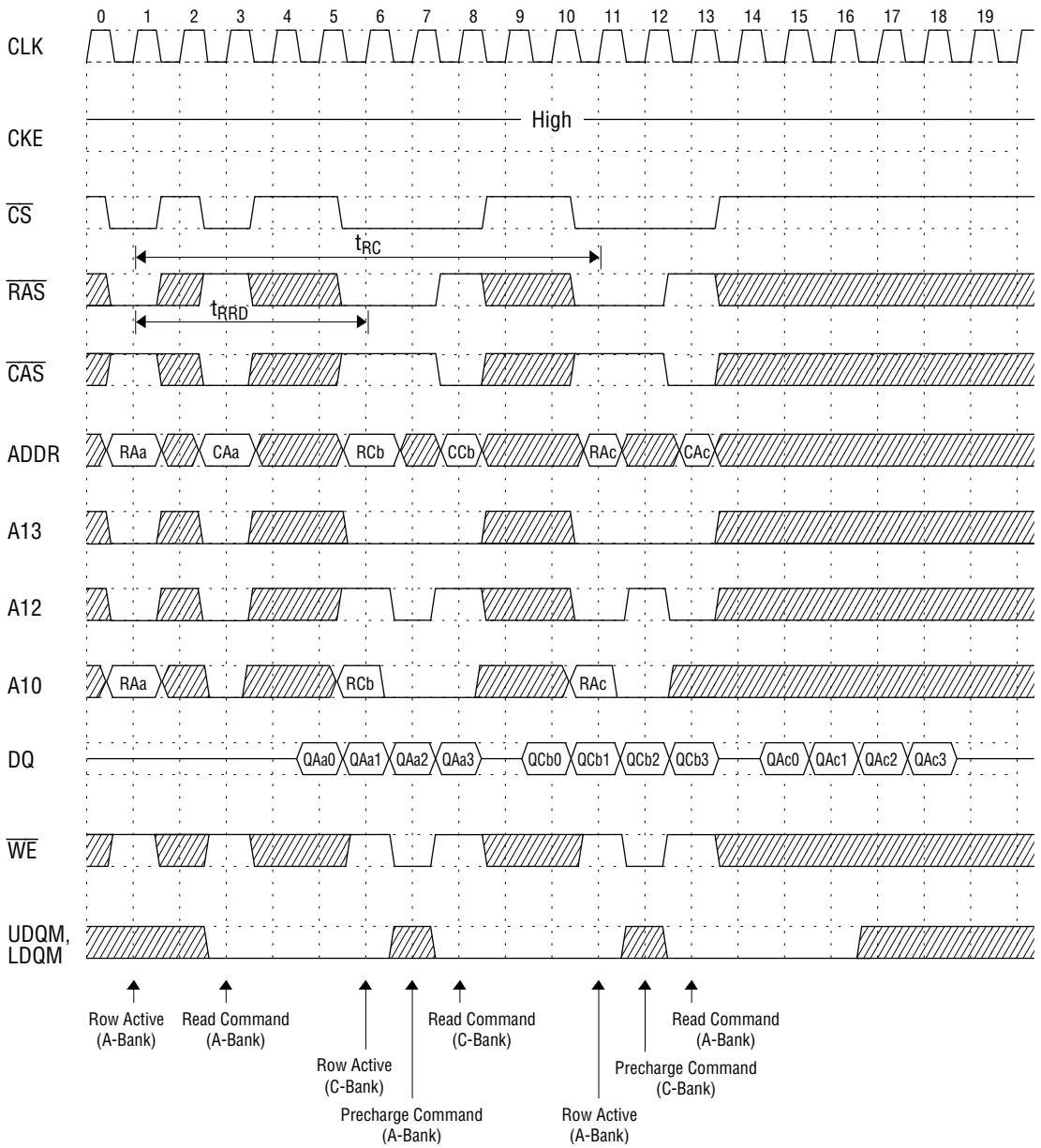

Bank Interleave Random Row Write Cycle @ $\overline{\text{CAS}}$ Latency = 2, Burst Length = 4

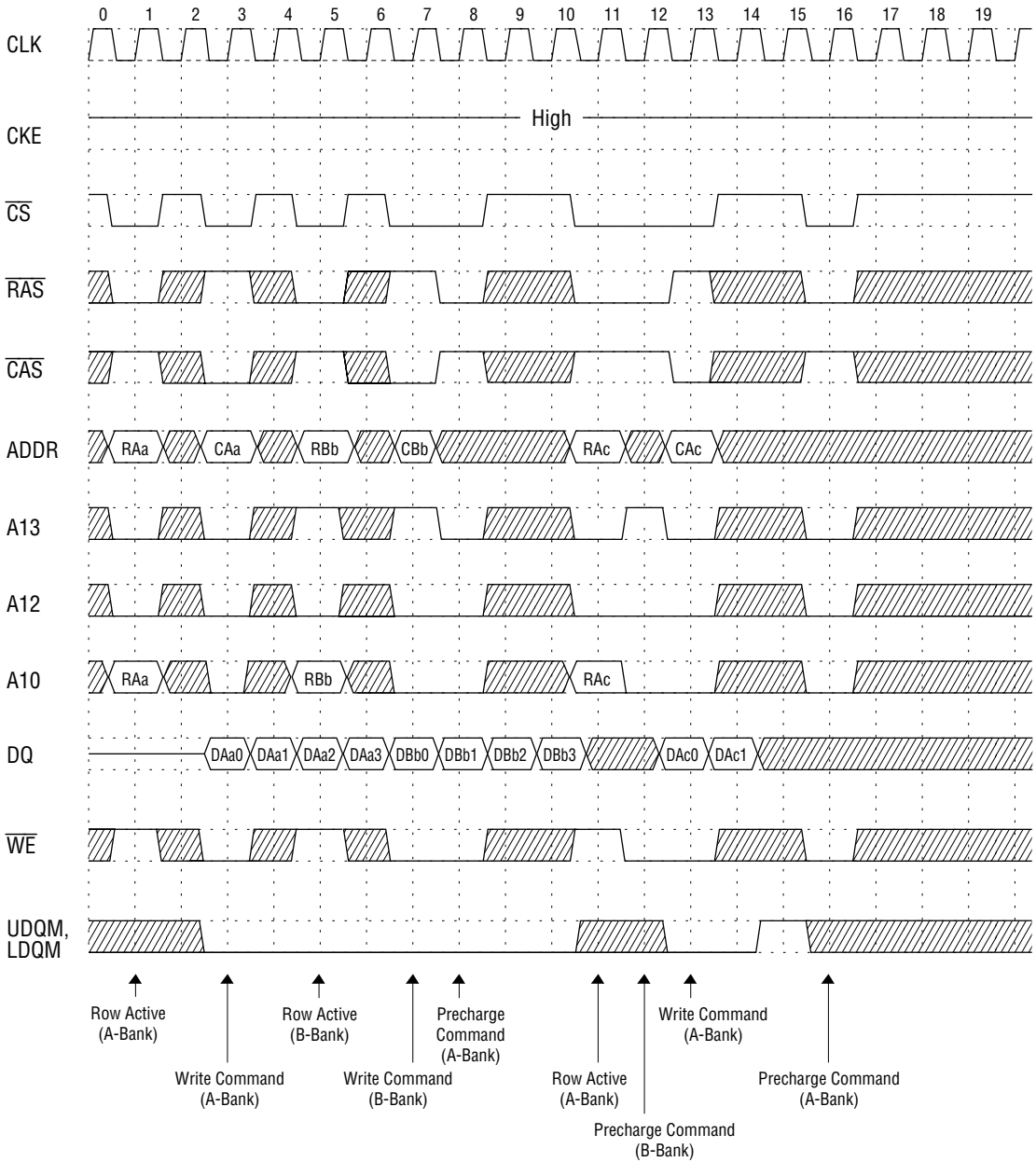

Bank Interleave Page Read Cycle @ $\overline{\text{CAS}}$ Latency = 2, Burst Length = 4

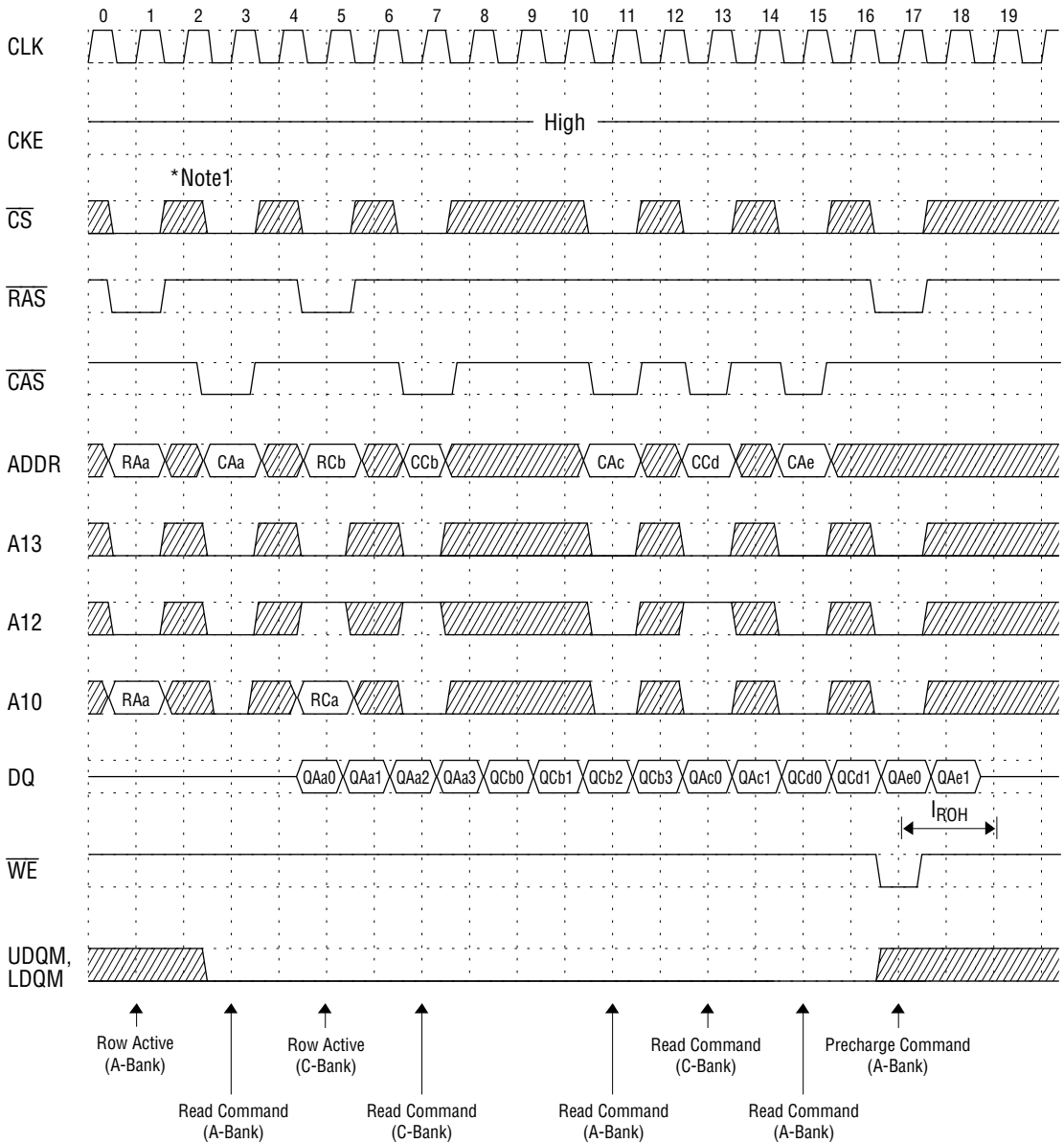

***Note:** 1. $\overline{\text{CS}}$ is ignored when $\overline{\text{RAS}}$, $\overline{\text{CAS}}$ and $\overline{\text{WE}}$ are high at the same cycle.

Bank Interleave Page Write Cycle @ $\overline{\text{CAS}}$ Latency = 2, Burst Length = 4

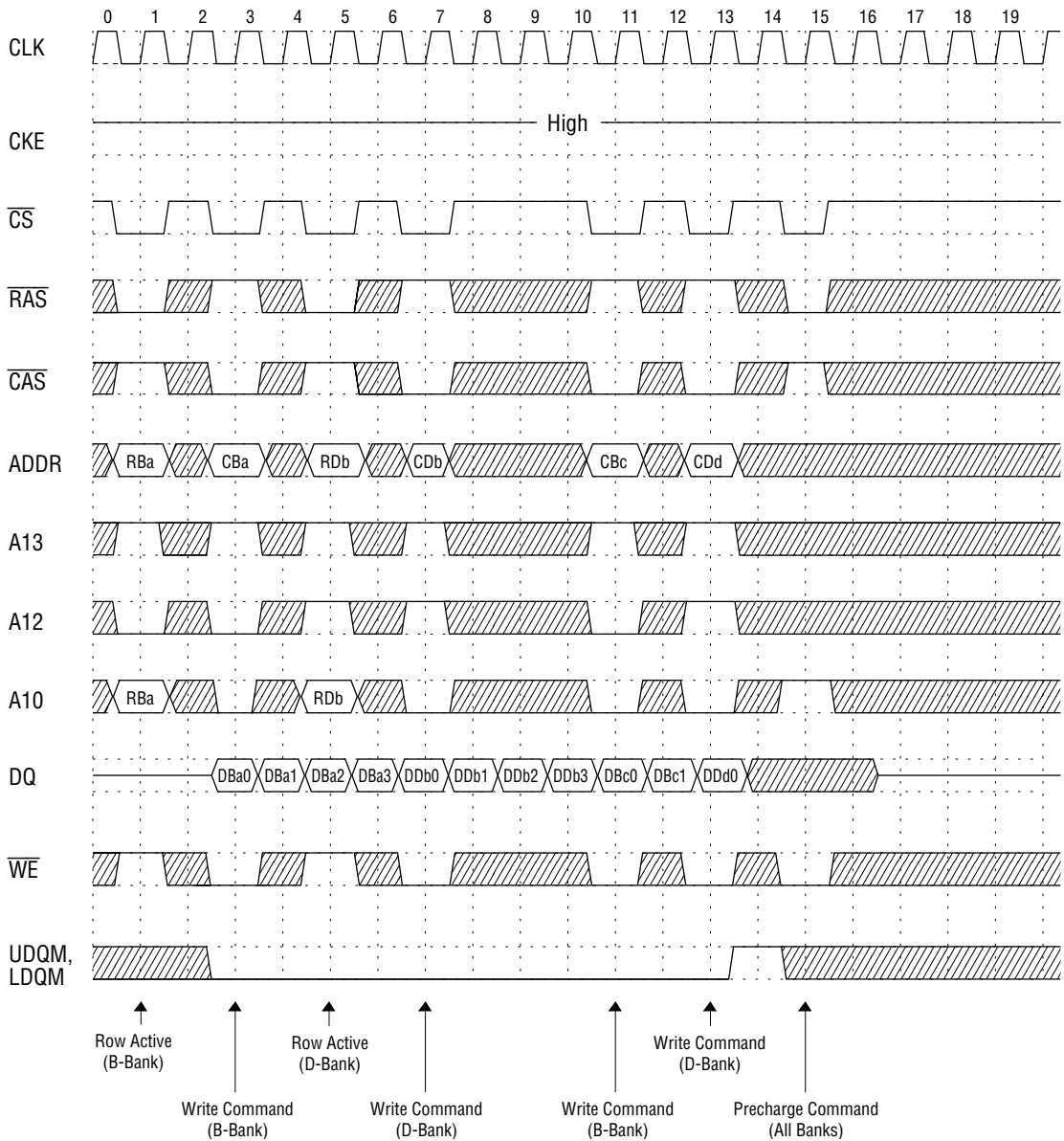

Bank Interleave Random Row Read/Write Cycle @ $\overline{\text{CAS}}$ Latency = 2, Burst Length = 4

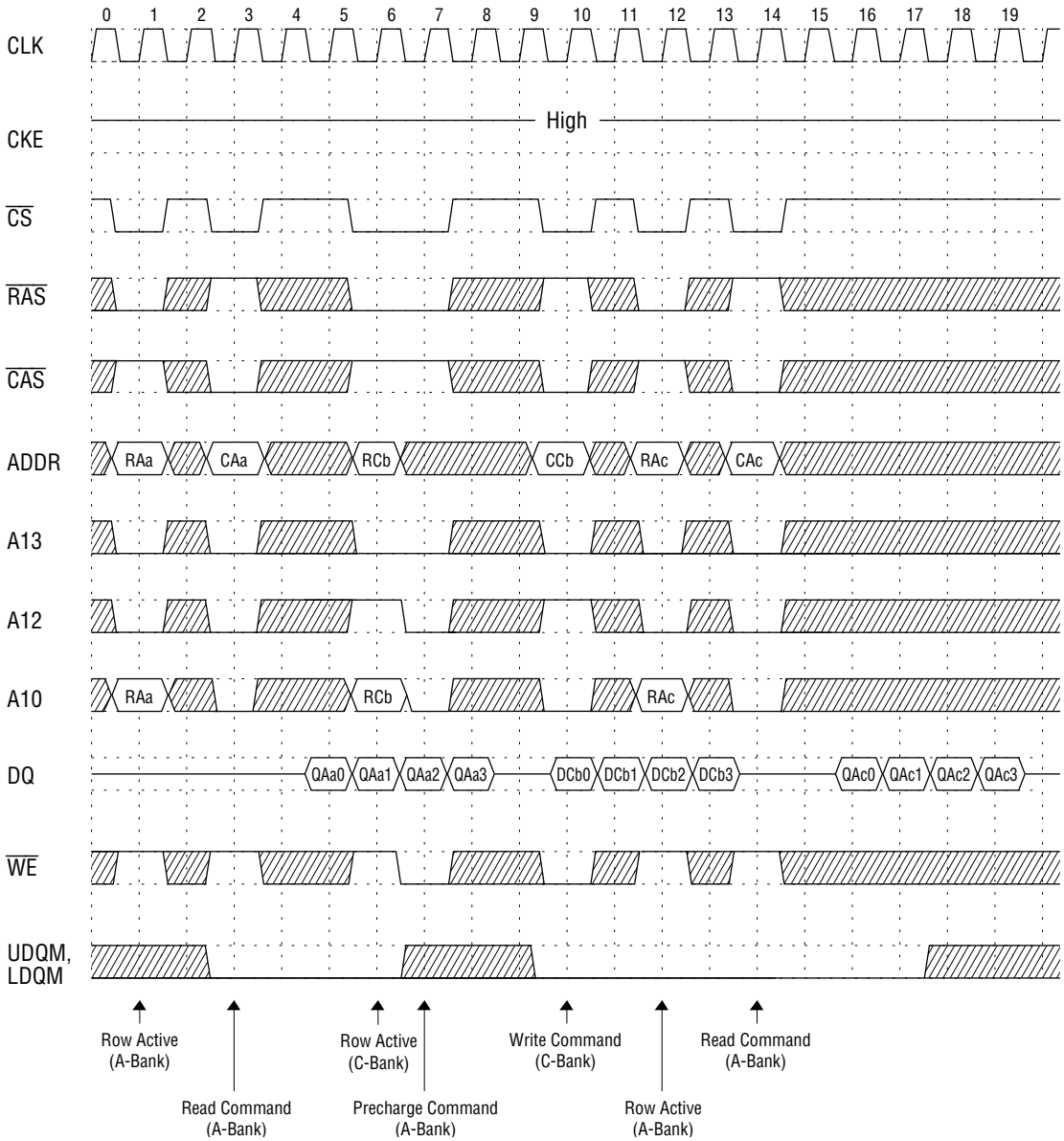

Bank Interleave Page Read/Write Cycle @ $\overline{\text{CAS}}$ Latency = 2, Burst Length = 4

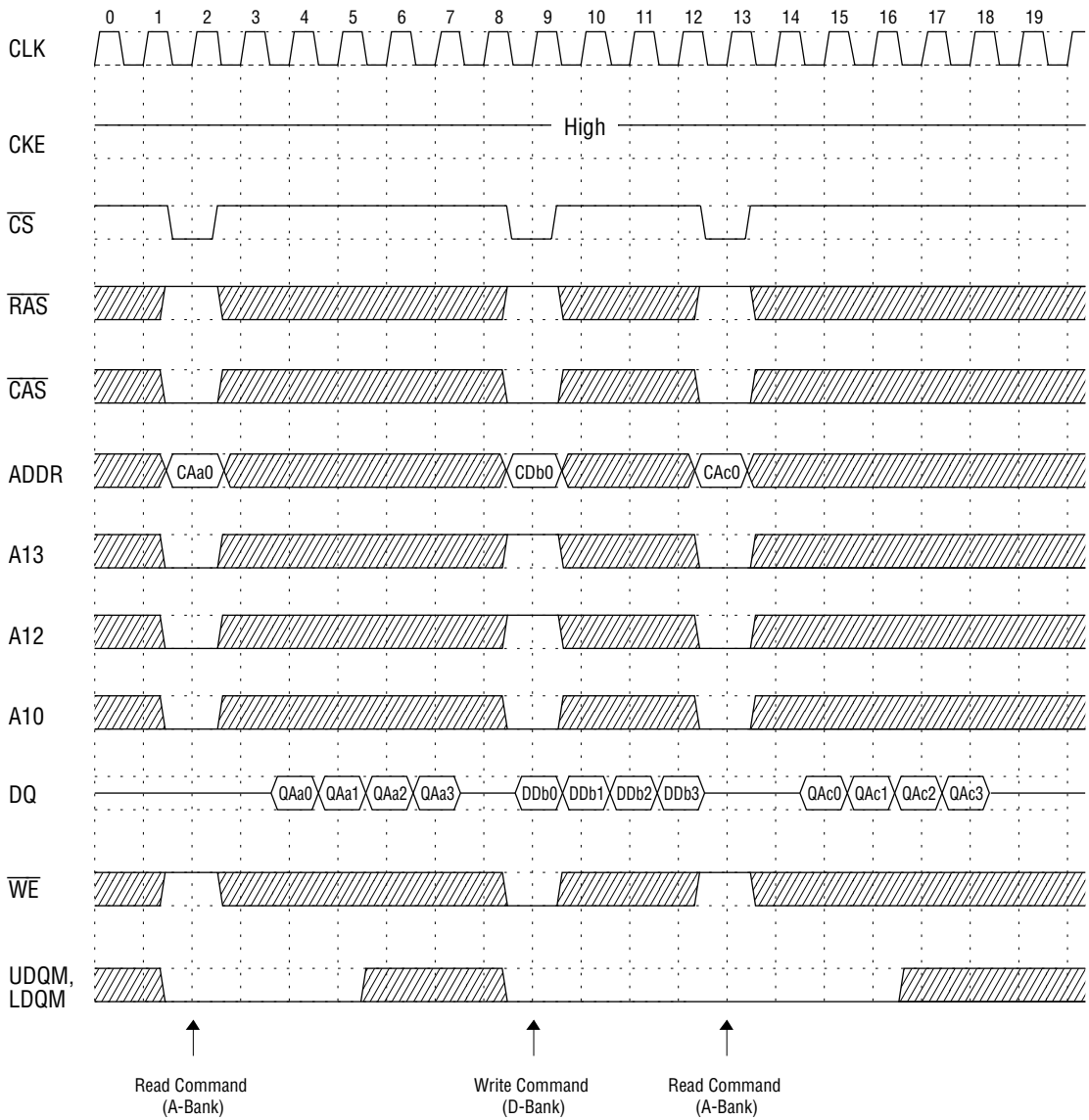

Clock Suspension & DQM Operation Cycle @ $\overline{\text{CAS}}$ Latency = 2, Burst Length = 4

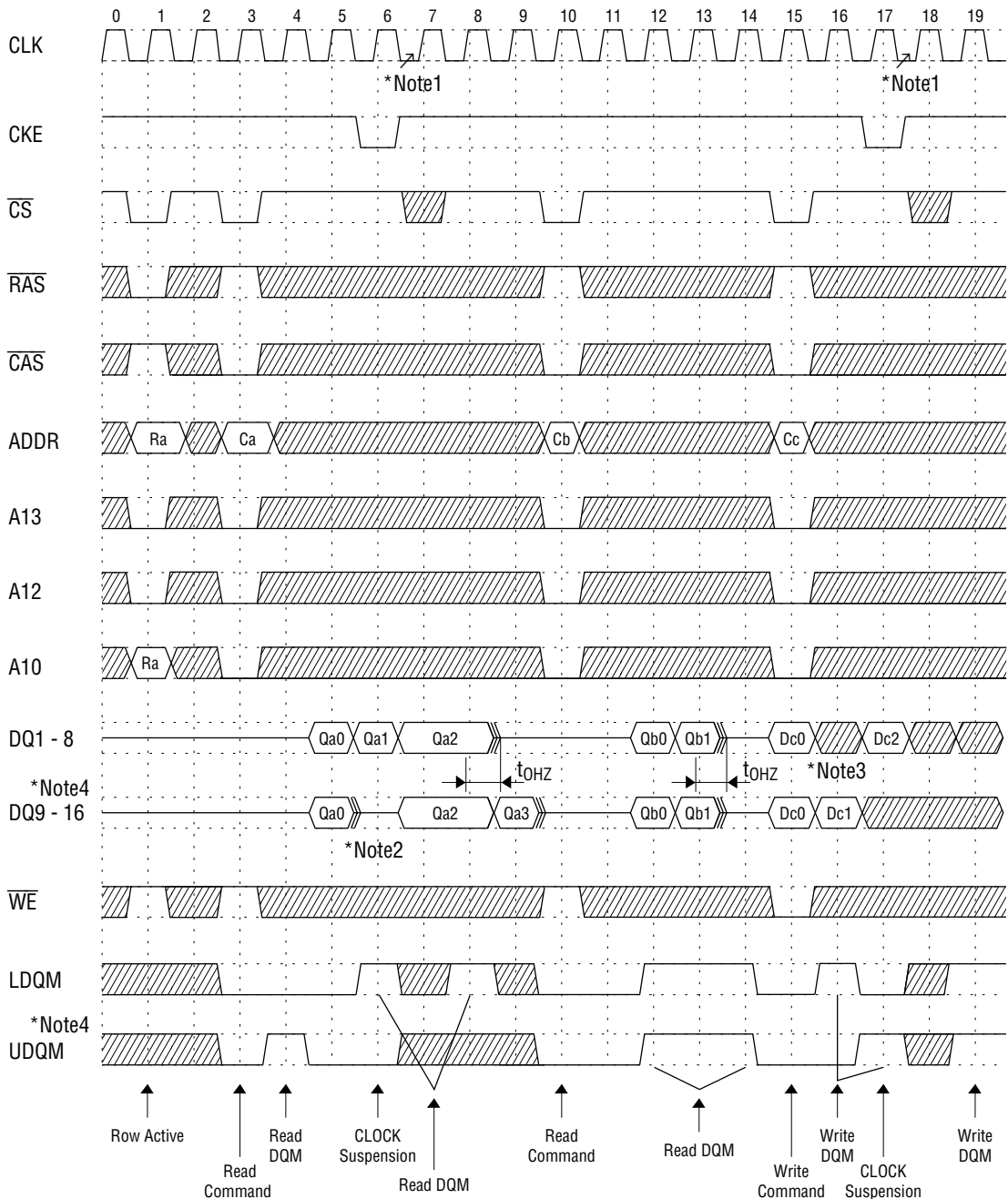

- *Notes:**
1. When Clock Suspension is asserted, the next clock cycle is ignored.
 2. When LDQM and UDQM are asserted, the read data after two clock cycles is masked.
 3. When LDQM and UDQM are asserted, the write data in the same clock cycle is masked.
 4. When LDQM is set High, the input/output data of DQ1 - DQ8 is masked.
When UDQM is set High, the input/output data of DQ9 - DQ16 is masked.

Read Interruption by Precharge Command @ Burst Length = 8

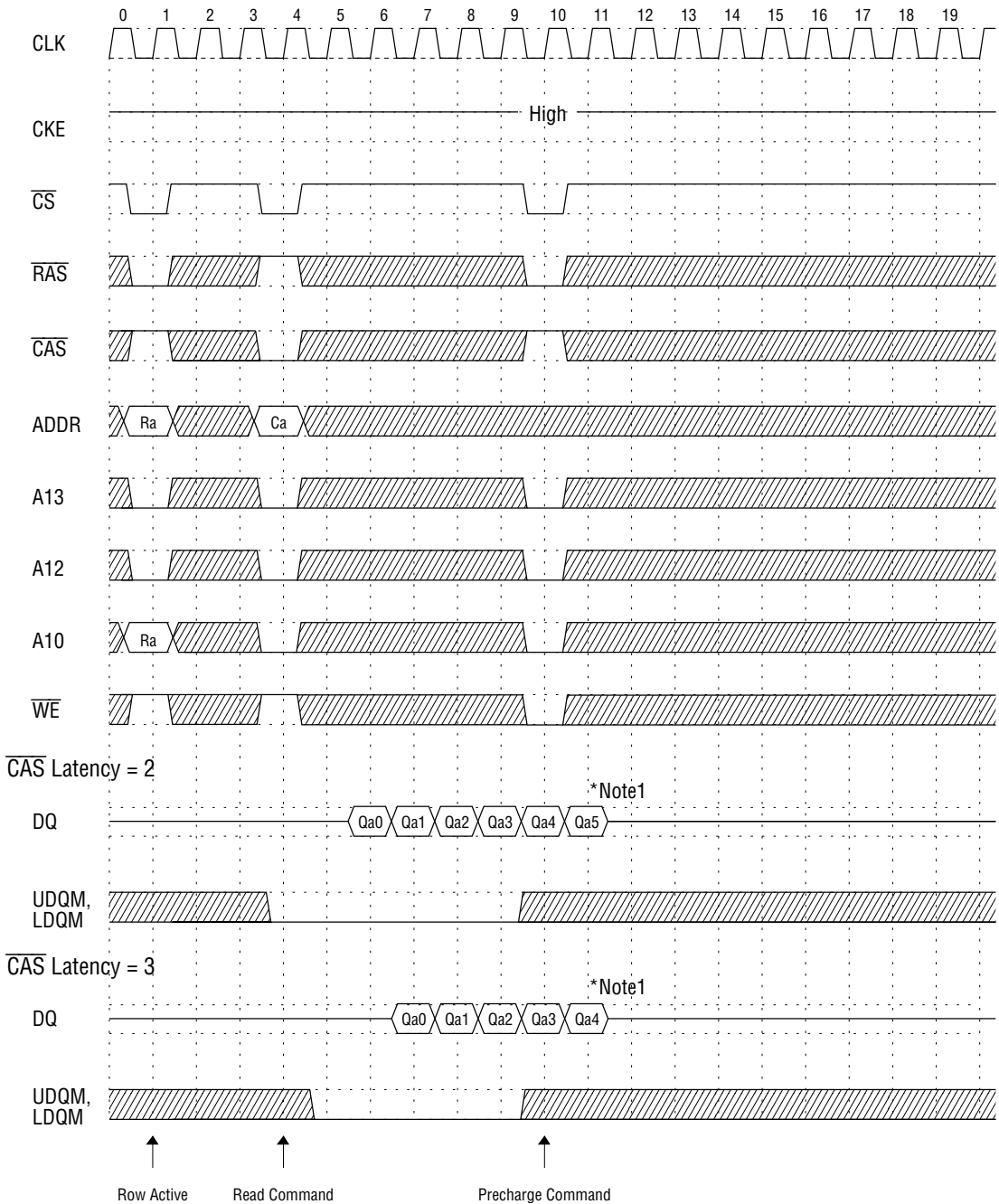

***Note:** 1. If row precharge is asserted before burst read ends, then the read data will not output after the second clock cycle of the precharge command.

Power Down Mode @ $\overline{\text{CAS}}$ Latency = 2, Burst Length = 4

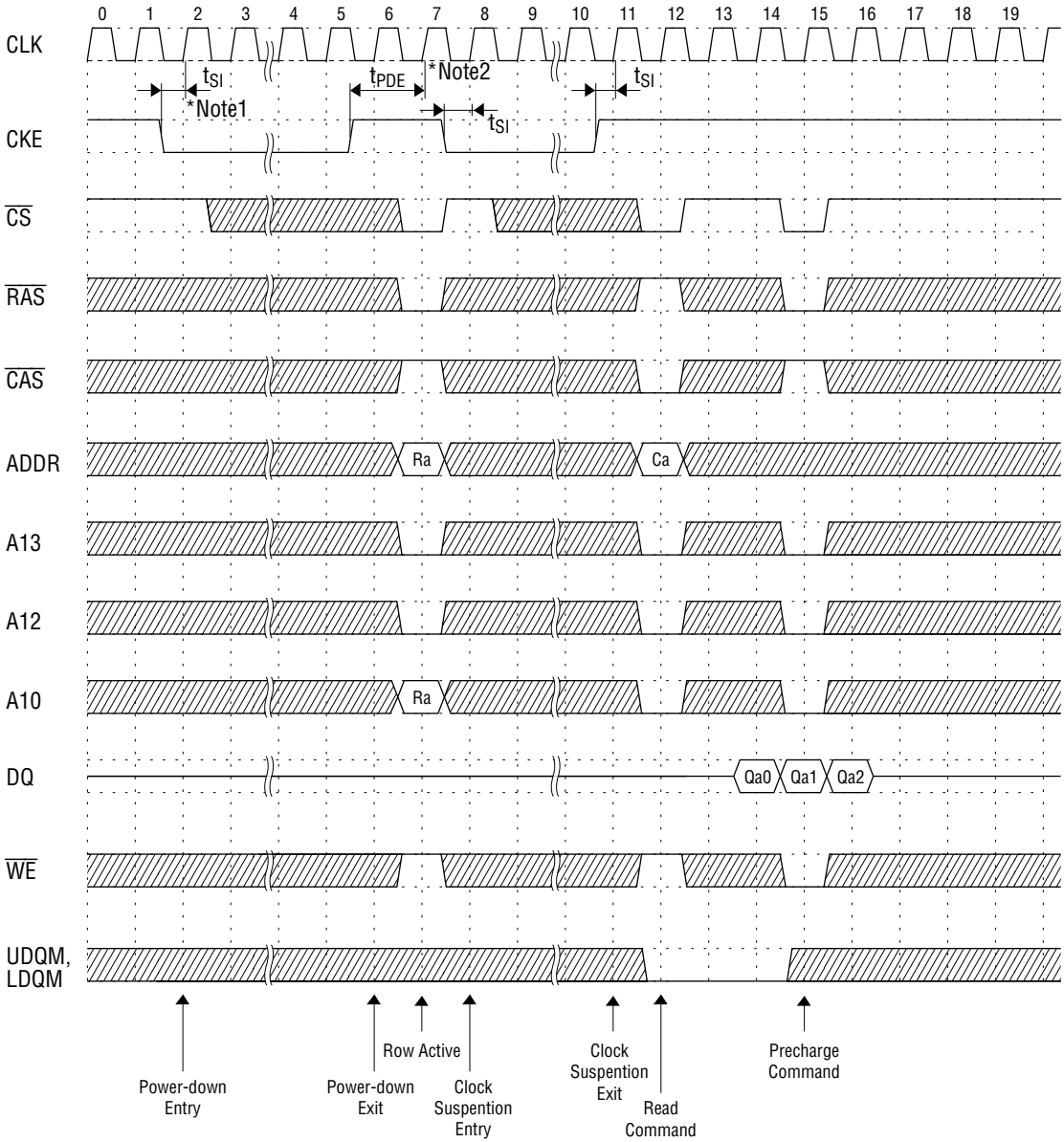

- *Notes:**
1. When all banks are in precharge state, and if CKE is set low, then the MD56V62160/H enters power-down mode and maintains the mode while CKE is low.
 2. To release the circuit from power-down mode, CKE has to be set high for longer than $t_{PDE} (t_{SI} + 1 \text{ CLK})$.

Self Refresh Cycle

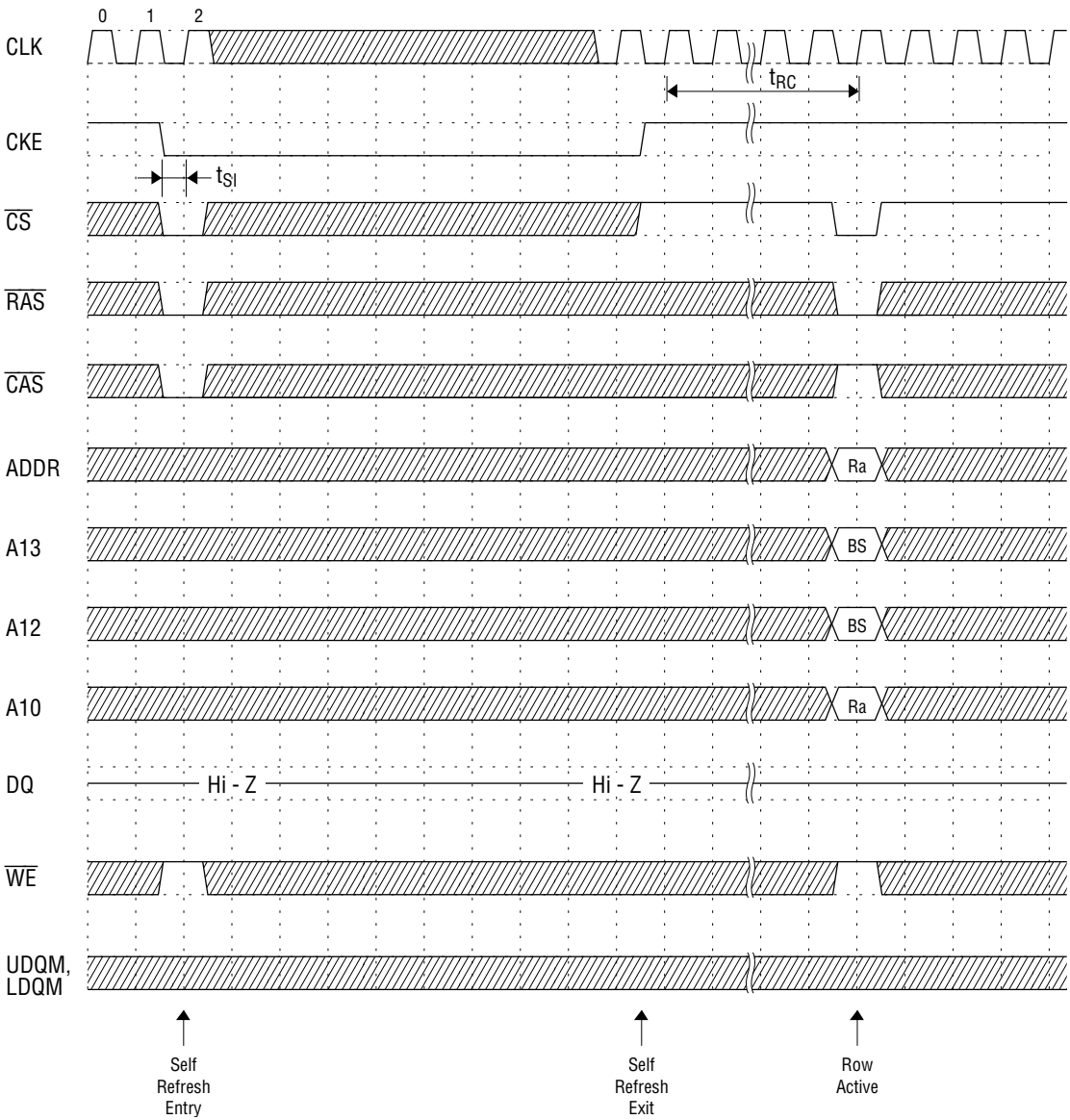

Mode Register Set Cycle

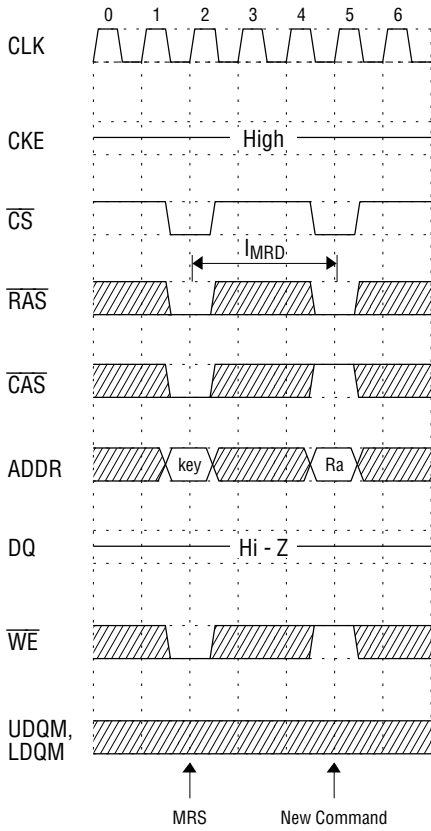

Auto Refresh Cycle

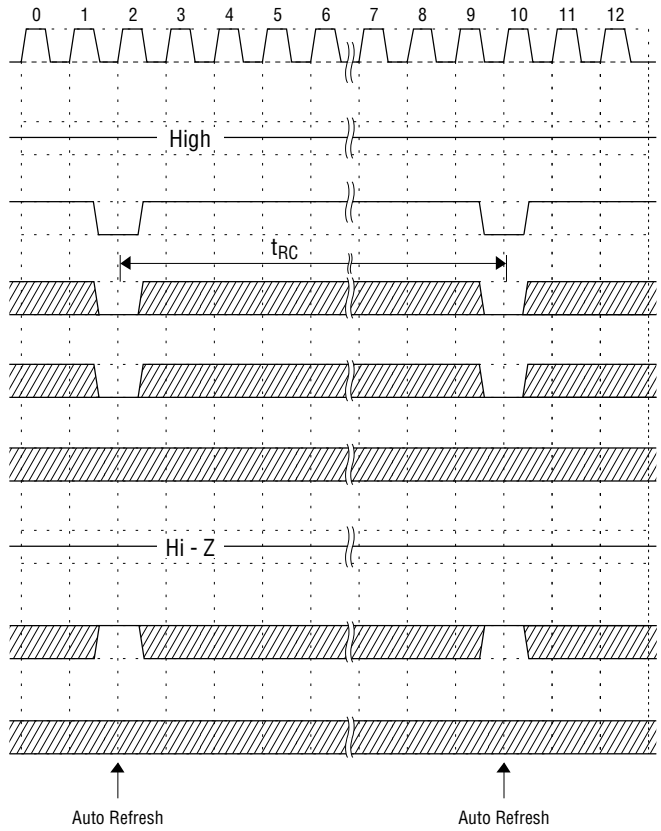

FUNCTION TRUTH TABLE (Table 1) (1/2)

Current State ¹	CS	RAS	CAS	WE	BA	ADDR	Action
Idle	H	X	X	X	X	X	NOP
	L	H	H	H	X	X	NOP
	L	H	H	L	BA	X	ILLEGAL ²
	L	H	L	X	BA	CA	ILLEGAL ²
	L	L	H	H	BA	RA	Row Active
	L	L	H	L	BA	A10	NOP ⁴
	L	L	L	H	X	X	Auto-Refresh or Self-Refresh ⁵
Row Active	L	L	L	L	L	OP Code	Mode Register Write
	H	X	X	X	X	X	NOP
	L	H	H	X	X	X	NOP
	L	H	L	H	BA	CA, A10	Read
	L	H	L	L	BA	CA, A10	Write
	L	L	H	H	BA	RA	ILLEGAL ²
	L	L	H	L	BA	A10	Precharge
Read	L	L	L	X	X	X	ILLEGAL
	H	X	X	X	X	X	NOP (Continue Row Active after Burst ends)
	L	H	H	H	X	X	NOP (Continue Row Active after Burst ends)
	L	H	H	L	BA	X	Reserved
	L	H	L	H	BA	CA, A10	Term Burst, start new Burst Read
	L	H	L	L	BA	CA, A10	Term Burst, start new Burst Write
	L	L	H	H	BA	RA	ILLEGAL ²
Write	L	L	H	L	BA	A10	Term Burst, execute Row Precharge
	L	L	L	X	X	X	ILLEGAL
	H	X	X	X	X	X	NOP (Continue Row Active after Burst ends)
	L	H	H	H	X	X	NOP (Continue Row Active after Burst ends)
	L	H	H	L	BA	X	Reserved (Term Burst) --> Row Active
	L	H	L	H	BA	CA, A10	Term Burst, start new Burst Read
	L	H	L	L	BA	CA, A10	Term Burst, start new Burst Write
Read with Auto Precharge	L	L	H	H	BA	RA	ILLEGAL ²
	L	L	H	L	BA	A10	Term Burst, execute Row Precharge
	L	L	L	X	X	X	ILLEGAL
	H	X	X	X	X	X	NOP (Continue Burst to End and enter Row Precharge)
	L	H	H	H	X	X	NOP (Continue Burst to End and enter Row Precharge)
	L	H	H	L	BA	X	ILLEGAL ²
	L	H	L	H	BA	CA, A10	ILLEGAL ²
Write with Auto Precharge	L	H	L	L	X	X	ILLEGAL
	L	L	H	X	BA	RA, A10	ILLEGAL ²
	L	L	L	X	X	X	ILLEGAL
	H	X	X	X	X	X	NOP (Continue Burst to End and enter Row Precharge)
	L	H	H	H	X	X	NOP (Continue Burst to End and enter Row Precharge)
	L	H	H	L	BA	X	ILLEGAL ²
Write with Auto Precharge	L	H	L	H	BA	CA, A10	ILLEGAL ²
	L	H	L	L	X	X	ILLEGAL
	L	L	H	X	BA	RA, A10	ILLEGAL ²
	L	L	L	X	X	X	ILLEGAL
	L	L	H	X	BA	RA, A10	ILLEGAL ²

FUNCTION TRUTH TABLE (Table 1) (2/2)

Current State ¹	CS	RAS	CAS	WE	BA	ADDR	Action
Precharge	H	X	X	X	X	X	NOP --> Idle after t_{RP}
	L	H	H	H	X	X	NOP --> Idle after t_{RP}
	L	H	H	L	BA	X	ILLEGAL ²
	L	H	L	X	BA	CA	ILLEGAL ²
	L	L	H	H	BA	RA	ILLEGAL ²
	L	L	H	L	BA	A10	NOP ⁴
	L	L	L	X	X	X	ILLEGAL
Write Recovery	H	X	X	X	X	X	NOP
	L	H	H	H	X	X	NOP
	L	H	H	L	BA	X	ILLEGAL ²
	L	H	L	X	BA	CA	ILLEGAL ²
	L	L	H	H	BA	RA	ILLEGAL ²
	L	L	H	L	BA	A10	ILLEGAL ²
	L	L	L	X	X	X	ILLEGAL
Row Active	H	X	X	X	X	X	NOP --> Row Active after t_{RCD}
	L	H	H	H	X	X	NOP --> Row Active after t_{RCD}
	L	H	H	L	BA	X	ILLEGAL ²
	L	H	L	X	BA	CA	ILLEGAL ²
	L	L	H	H	BA	RA	ILLEGAL ²
	L	L	H	L	BA	A10	ILLEGAL ²
	L	L	L	X	X	X	ILLEGAL
Refresh	H	X	X	X	X	X	NOP --> Idle after t_{RC}
	L	H	H	X	X	X	NOP --> Idle after t_{RC}
	L	H	L	X	X	X	ILLEGAL
	L	L	H	X	X	X	ILLEGAL
	L	L	L	X	X	X	ILLEGAL
Mode Register Access	H	X	X	X	X	X	NOP
	L	H	H	H	X	X	NOP
	L	H	H	L	X	X	ILLEGAL
	L	H	L	X	X	X	ILLEGAL
	L	L	X	X	X	X	ILLEGAL

ABBREVIATIONS

RA = Row Address

BA = Bank Address

NOP = No Operation command

CA = Column Address

AP = Auto Precharge

- Notes:
1. All inputs are enabled when CKE is set high for at least 1 cycle prior to the inputs.
 2. Illegal to bank in specified state, but may be legal in some cases depending on the state of bank selection.
 3. Satisfy the timing of t_{CCD} and t_{WR} to prevent bus contention.
 4. NOP to bank precharging or in idle state. Precharges activated bank by BA or A10.
 5. Illegal if any bank is not idle.

FUNCTION TRUTH TABLE for CKE (Table 2)

Current State (n)	CKEn-1	CKEn	CS	RAS	CAS	WE	ADDR	Action
Self Refresh	H	X	X	X	X	X	X	INVALID
	L	H	H	X	X	X	X	Exit Self Refresh --> ABI
	L	H	L	H	H	H	X	Exit Self Refresh --> ABI
	L	H	L	H	H	L	X	ILLEGAL
	L	H	L	H	L	X	X	ILLEGAL
	L	H	L	L	X	X	X	ILLEGAL
	L	L	X	X	X	X	X	NOP (Maintain Self Refresh)
Power Down	H	X	X	X	X	X	X	INVALID
	L	H	H	X	X	X	X	Exit Power Down --> ABI
	L	H	L	H	H	H	X	Exit Power Down --> ABI
	L	H	L	H	H	L	X	ILLEGAL
	L	H	L	H	L	X	X	ILLEGAL
	L	H	L	L	X	X	X	ILLEGAL ⁶
	L	L	X	X	X	X	X	NOP (Continue power down mode)
All Banks Idle ⁶ (ABI)	H	H	X	X	X	X	X	Refer to Table 1
	H	L	H	X	X	X	X	Enter Power Down
	H	L	L	H	H	H	X	Enter Power Down
	H	L	L	H	H	L	X	ILLEGAL
	H	L	L	H	L	X	X	ILLEGAL
	H	L	L	L	H	L	X	ILLEGAL
	H	L	L	L	L	H	X	Enter Self Refresh
	H	L	L	L	L	L	X	ILLEGAL
	L	L	X	X	X	X	X	NOP
Any State Other than Listed Above	H	H	X	X	X	X	X	Refer to Operations in Table 1
	H	L	X	X	X	X	X	Begin Clock Suspend Next Cycle
	L	H	X	X	X	X	X	Enable Clock of Next Cycle
	L	L	X	X	X	X	X	Continue Clock Suspension

Note: 6. Power-down and self refresh can be entered only when all the banks are in an idle state.