



MASK168

User's Manual

ML64168 Mask Option Generator

First Edition
October 1998

NOTICE

1. The information contained herein can change without notice owing to product and/or technical improvements. Before using the product, please make sure that the information being referred to is up-to-date.
2. The outline of action and examples for application circuits described herein have been chosen as an explanation for the standard action and performance of the product. When planning to use the product, please ensure that the external conditions are reflected in the actual circuit and assembly designs.
3. When developing and evaluating your product, please use our product below the specified maximum ratings and within the specified operating ranges including, but not limited to, operating voltage, power dissipation, and operating temperature.
4. **OKI assumes no responsibility or liability whatsoever for any failure or unusual or unexpected operation resulting from misuse, neglect, improper installation, repair, alteration or accident, improper handling, or unusual physical or electrical stress including, but not limited to, exposure to parameters beyond the specified maximum ratings or operation outside the specified operating range.**
5. Neither indemnity against nor license of a third party's industrial and intellectual property right, etc. is granted by us in connection with the use of product and/or the information and drawings contained herein. No responsibility is assumed by us for any infringement of a third party's right which may result from the use thereof.
6. The products listed in this document are intended only for use in development and evaluation of control programs for equipment and systems. These products are not authorized for other use (as an embedded device and a peripheral device).
7. Certain products in this document may need government approval before they can be exported to particular countries. The purchaser assumes the responsibility of determining the legality of export of these products and will take appropriate and necessary steps at their own expense for these.
8. No part of the contents contained herein may be reprinted or reproduced without our prior permission.
9. MS-DOS is a registered trademark of Microsoft Corporation.

Copyright 1998 Oki Electric Industry Co., Ltd.

Preface

This document describes operating procedures for the MASK168 mask option generator, a tool for preparing LCD segment data for the Oki MSM64168 4-bit CMOS microcontroller and converting it to mask option data.

It is to be read in conjunction with the following manuals.

■ MSM64168 User's Manual

- MSM64168 hardware description
- MSM64168 software description

■ SASM64K Structured Assembler User's Manual

- SASM64K structured assembler operation
- SASM64K structured assembler language description

■ EASE64168 User's Manual

- ML64168 program development support system description

Contents

Chapter 1. Overview Page

1. MASK168 Mask Option Generator	1
2. Output Files.....	3
3. Using Intel HEX Format Mask Option File	4

Chapter 2. Operation

1. Start-Up	1
1.1 Operating Environment	1
1.2 Starting the Software	1
1.3 Specifying Chip Code.....	3
2. Operation Menu	5
2.1 Menu Choices	5
2.2 Creating LCD Segment Mask Option Table	6
2.3 Adding to LCD Segment Mask Option Table	12
2.4 Editing LCD Segment Mask Option Table	13
2.5 Editing Remaining Mask Options	15
2.6 Printing LCD Segment Mask Option Table	17
2.7 Displaying Display Data Register and Bit Assignments.....	18
2.8 Invoke Subshell	19
2.9 Exiting Program.....	19

Chapter 3. Output Files

1. Mask Option Files	1
1.1 SEG64168.XXX	1
1.2 DUTY168.XXX.....	1
1.3 OP168.XXX.....	1
1.4 DN168_n.XXX ($n=1$ to 4)	1
1.5 SD168_n.XXX ($n=1$ to 4).....	2
1.6 SS168.XXX	2
1.7 CS168_n.XXX ($n=1$ to 2)	2
1.8 M168_XXX.HEX.....	2
2. Addresses for Mask Option Data	3

Appendices

Appendix-1 Data Tables.....	1
Appendix-2 Sample Completed Mask Options Tables.....	4

Chapter 1. Overview

This Chapter describes MASK168 operation and applications.

1. MASK168 Mask Option Generator

The MASK168 mask option generator produces an Intel HEX format mask option file for an Oki ML64168 4-bit CMOS microcontroller from user specifications. The following mask options are available.

- ① Port, common, and segment assignments for the LCD segment pins (L0 to L33)
- ② Display data and register assignments for the LCD segment pins
- ③ Operating power supply voltage
- ④ Crystal oscillator capacitor CG flag
- ⑤ LCD voltage regulator flag

MASK168 takes these user specifications and writes the appropriate values to the corresponding addresses in the Intel HEX format output file.

The following Figure outlines the processing flow.

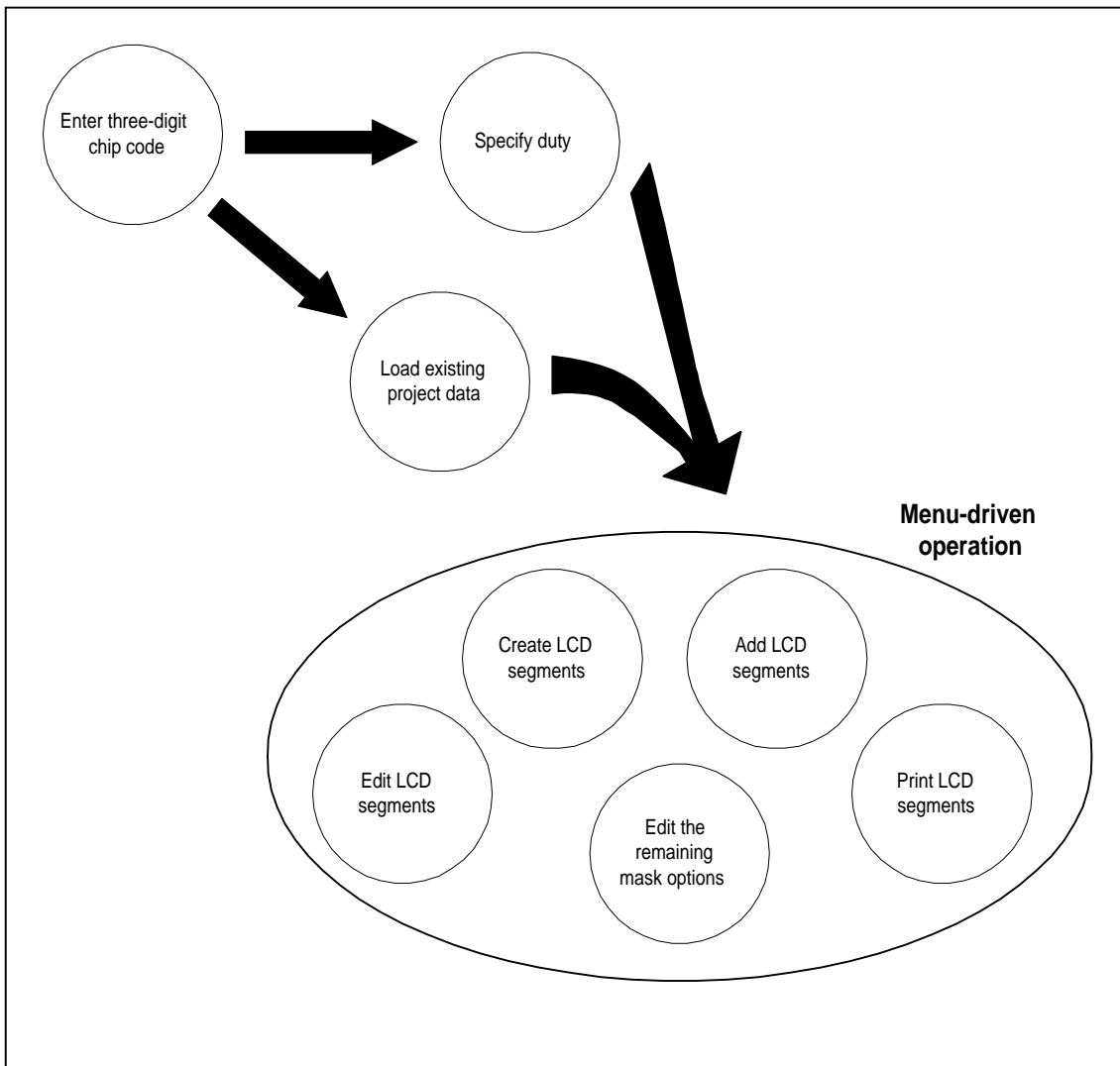

Figure 1-1 MASK168 Processing Flow

2. Output Files

Based on the mask option specifications from the preceding Section, the MASK168 mask option generator produces 15 files.

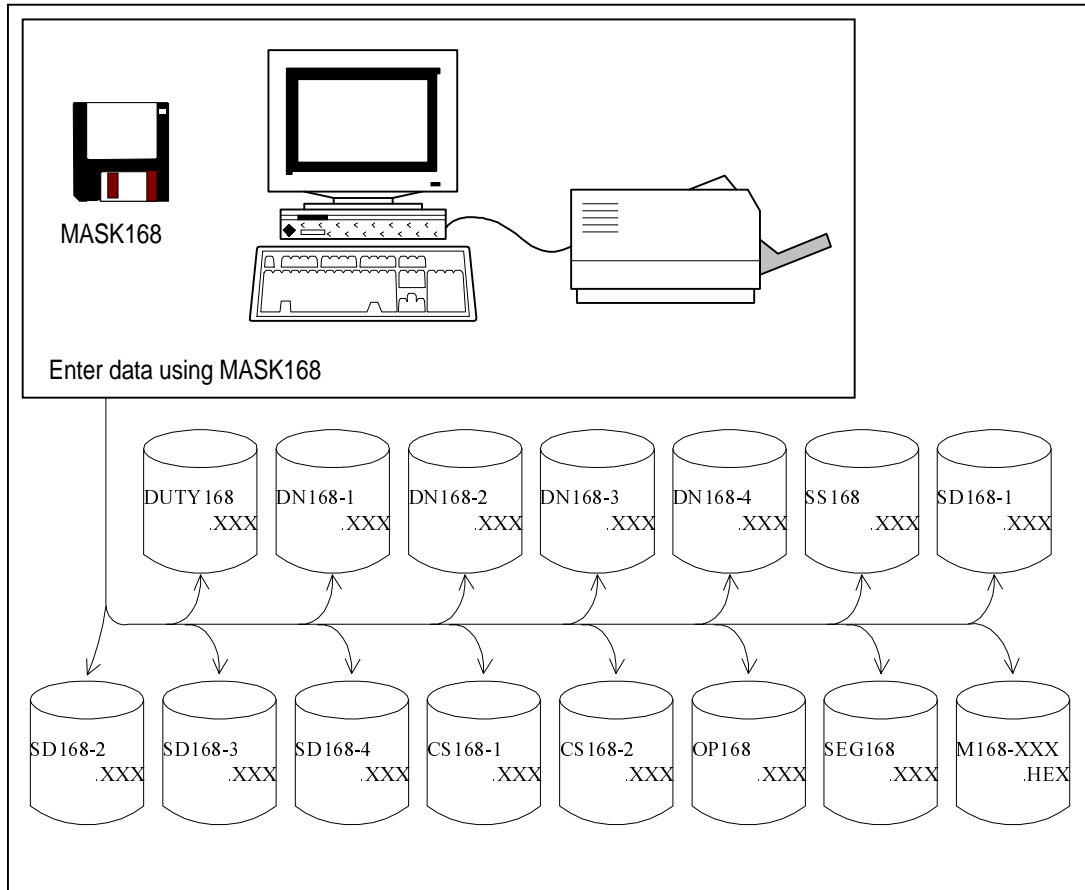

Figure 1-2 Mask Option Files

The Intel HEX format mask option file is the one with the extension .HEX. The other 14 files contain the data for the specified project.

The Intel HEX format mask option file appear in the next Section.



Throughout this document, the XXX in file names and extensions is the chip code, a three-digit identifier for distinguishing chip versions (ML64168-XXX). For further details, see Section 2.1.3 “Specifying Chip Code.”

3. Using Intel HEX Format Mask Option File

The Intel HEX format mask option file (hereinafter referred to as the “.HEX file”) from the MASK168 mask option generator has two main applications:

- Configuring the EASE64168 in-circuit emulator for debugging the user application program (See Note.)
- Producing mask data for the production version of the ML64168

The following Figure summarizes the processing flow.

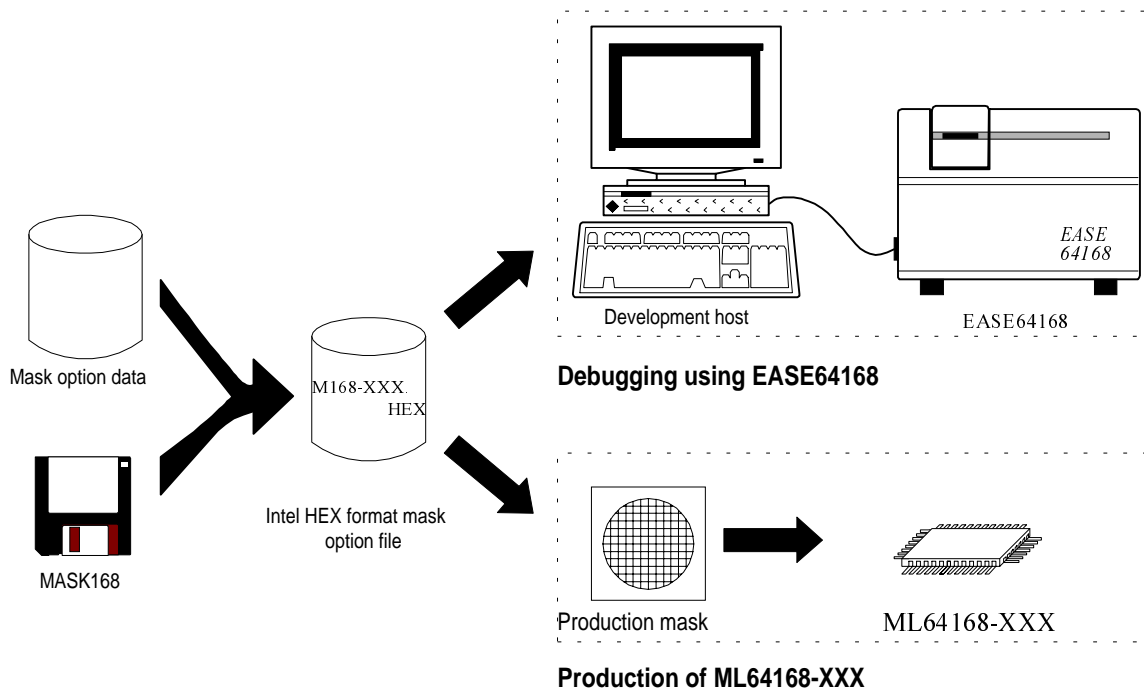

Figure 1-3 Using Mask Option File

Note 1

Program debugging with the EASE64168 in-circuit emulator uses only the following data from the Intel HEX format mask option file from the MASK168 mask option generator: port pin assignments for the segments, common and segment assignments, and segment display data and register assignments. Remember that the debugging phase does not validate the remaining mask options: operating power supply voltage, crystal oscillator capacitor CG flag, and LCD voltage regulator flag. The debugger command for configuring the EASE64168 with a mask option file is LODM. For further details, refer to the EASE64168 User's Manual.

Chapter 2. Operation

This Chapter gives the detailed procedures for using the MASK168 mask option generator.

1. Start-Up

1.1 Operating Environment

The MASK168 mask option generator has the following modest requirements.

- Version 3.1 or later of the MS-DOS operating system
- A minimum of 100 kilobytes of free RAM (See Note 1.)
- Printer on line and ready (See Note 2.)

Note 1

This 100-kilobyte RAM requirement represents approximately 90 kilobytes for the executable (MASK168.EXE) and approximately 10 kilobytes for data buffers.

Note 2

Make sure that the printer is on line and ready before starting the program.

1.2 Starting the Software

The following is the procedure for starting the software.

① Turn on the computer and display a command line prompt.

② Change to the directory for storing the data files. (The program always stores its files in the current directory.)

③ Load the executable.

- If the executable (MASK168.EXE) is in a directory on the search path, simply enter the command name.
- Otherwise—or if you want fastest possible loading—prepend the path to the executable.

④ Wait for the program prompt to appear.

```
ML64168 Mask Option Generator Version X.XX XXX XXXX  
Copyright (C) XXXX. Oki Electric Ind.Co.,Ltd.
```

```
[ Code Number ] : ML64168-__
```

The first program prompt to appear is always the one asking for the chip code.

The procedures for entering this code and the duty appear in the next Section.

1.3 Specifying Chip Code

As the preceding Section noted, the program always starts by asking for the chip code, the three-digit identifier for individual chip models, used in file names and extensions.

① Enter the chip code.

When the program first starts, it displays the following message prompting for the chip code. There is room for up to three digits. This code is used in file names and extensions.

```
ML64168 Mask Option Generator Version X.XX XXX XXXX  
Copyright (C) XXXX. Oki Electric Ind.Co.,Ltd.
```

```
[ Code Number ] : ML64168-__
```

If you enter only one or two digits, the program automatically pads the number with leading zeros. Entering an empty string, however, aborts the program, returning you to the command line prompt.

Example

Entering 123 specifies data files with names similar to the following.

```
M168_123.HEX  
SEG64168.123
```

Example

Entering 7 specifies data files with names similar to the following.

```
M168_007.HEX  
SEG64168.007
```

Note: If the specified data files already exist in the current directory, the program reads in three of them (SEG168.XXX, OP168.XXX, and DUTY168.XXX) and skips to the end of this procedure.

② Enter the duty.

If the specified data files do not already exist in the current directory, the program displays first a message similar to the following and then the duty selection prompt.

```
SEG64168.XXX is New File
```

```
[ Input Duty ] : 1/2 : 2, 1/3 : 3, 1/4 : 4 ---> _
```

Specify the denominator (2, 3, or 4) and press the Enter key. Alternatively, simply press the Enter key to accept the default (1/4).

- 2 1/2 duty
- 3 1/3 duty
- 4 1/4 duty
- Default duty (1/4)

The program stores this setting in the file DUTY168.XXX.

When the above procedure is complete—that is, you have specified the duty or the program has read in the data—the program displays its operation menu, the topic of the next section.

```
SEG64168.XXX File Reading...
```

2. Operation Menu

2.1 Menu Choices

Once the program has the chip code, it displays its operation menu.

```

<< ML64168 Mask Option Generator >>

  - M E N U -
  1 : Create LCD Segment
  2 : Append LCD Segment
  3 : Display and Edit LCD Segment
  4 : Display and Edit Option Data
  5 : Print LCD Segment
  6 : Display DSPR Table
  7 : Shell
  8 : Exit

  Select (1 - 8) -->__

```

Enter the number for the desired selection.

1	Create LCD segments	Create LCD segment mask option table
2	Add LCD segments	Add to LCD segment mask option table
3	Edit LCD segments	Edit LCD segment mask option table
4	Edit remaining mask options	Edit the remaining mask options (See Note.)
5	Print LCD segments	Print LCD segment mask option table
6	Display SFR table	Display display data and register bit assignments
7	Shell	Load command line interpreter specified by environment variable COMSPEC
8	Exit	Exit the program

The rest of this Section discusses the above choices individually.

Note 1

Throughout this document, “remaining mask options” refers to the following subset: operating power supply voltage, crystal oscillator capacitor CG flag, and LCD voltage regulator flag.

2.2 Creating LCD Segment Mask Option Table

Item #1 on the operation menu activates the LCD segment mask option table editor at the first segment.

[[SEGMENT INPUT MODE]]		
<<	ML64168 - XXX	>> (See Note 2.)
**	SEGMENT No.Lx	** (See Note 2.)

There are six major steps: three for the segment pins and three for the remaining mask options.

① Pin configuration (common, segment, or port)

Com / Seg / Port ---> _

This step, for configuring the segment pin output, offers the following commands.

- C Assign segment pin for common output
- S Assign segment pin for segment output
- P Assign segment pin for port output (See Note 3.)
- . (period) Mark the segment pin as unused and start over from step 1 for the next segment
- Leave the rest of the segment pin entry as is and start over from step 1 for the next segment
- (minus) Start over from step 1 for the preceding segment
- / Terminate table editing and proceed to the remaining mask options (step 4)

Note 2

Throughout this document, XXX stands for the chip code. Here, Lx is the current segment number (L0 to L33).

Note 3

The P command is only available for segment numbers L26 and above.

② LCD segment names for signals

Specify segment names, up to six letters and digits, for the signals.

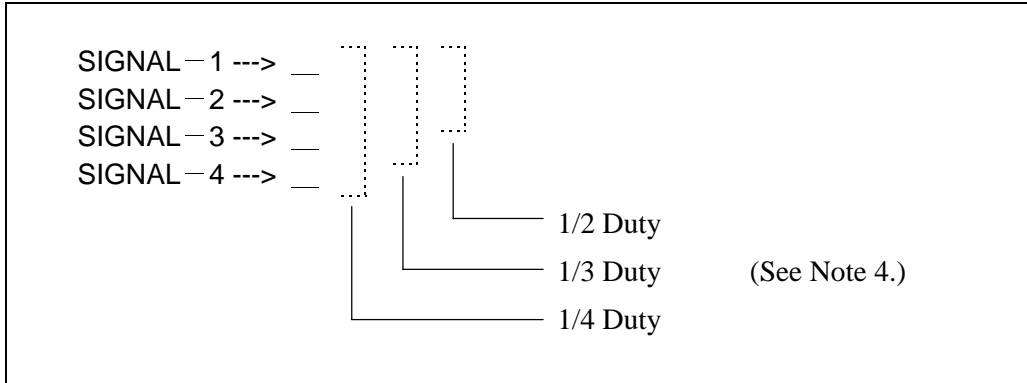

In addition to data entry, this step also offers the following subset of the commands from the first step.

- . (period) Mark the segment pin as unused and start over from step 1 for the next segment
- Leave the rest of the segment pin entry as is and start over from step 1 for the next segment
- (minus) Back up to the preceding step (within the same segment pin entry)
- / Terminate table editing and proceed to the remaining mask options (step 4)

! If the command for the first step was “C” (common output), the signal names must be the following. There is only one common output for each segment.

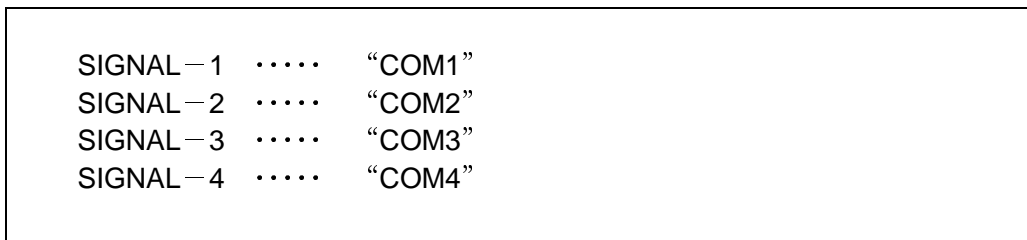

If the command for the first step was “P” (port output), however, the only signal is SIGNAL-1.

Note 4

The number of signals depends on the duty: two for 1/2, three for 1/3, or four for 1/4.

③ Display data and registers (DATA and DSPR)

Specify a lower case letter between 'a' and 'd' for the DATA member of the pair and a decimal value between 0 and 20 for the display data register.

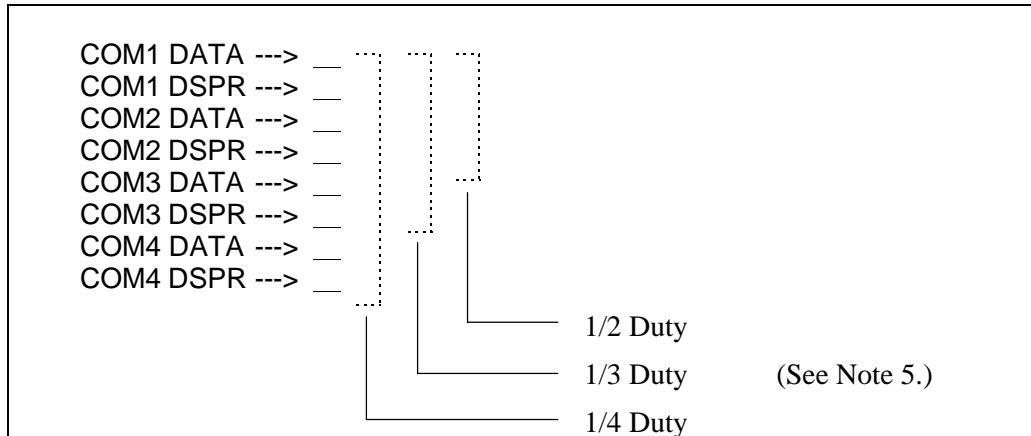

In addition to data entry, this step also offers the following subset of the commands from the first step.

- . (period) Mark the segment pin as unused and start over from step 1 for the next segment
- Leave the rest of the segment pin entry as is and start over from step 1 for the next segment
- (minus) Back up to the preceding step (within the same segment pin entry)
- / Terminate table editing and proceed to the remaining mask options (step 4)



If the command for the first step was "C" (common output), this step does not appear.



If the command for the first step was "P" (port output), however, there is only one pair (COM1 DATA and COM1 DSPR), and DSPR is limited to 0 or 1.



If the command for the second step was "." (unused), however, "." becomes the only possibility for all DATA-DSPR pairs as well.

Note 5

The number of DATA-DSPR pairs depends on the duty: two for 1/2, three for 1/3, or four for 1/4.

④ Power supply voltage

Filling the LCD segment mask option table or terminating the table editor with the “/” command advances to the steps for editing the remaining mask options: operating power supply voltage, crystal oscillator capacitor CG flag, and LCD voltage regulator flag.

```
[[ SEGMENT INPUT MODE ]]  
  
  << MSM64168 - XXX >>  
  
Voltage of Power Supply (1.5v : 0 / 3v : 1)  
  
Input ---> __
```

This step offers two voltage choices and two commands.

- 0 Specify a power supply voltage of 1.5 V
- 1 Specify a power supply voltage of 3 V
- Accept the default (1.5 V) and advance to the next step
- / Terminate editing and return to the operating menu

⑤ Crystal oscillator capacitor CG flag

```
X'tal CG Existence (Nonexist : 0 / Exist : 1)  
  
Input ---> __
```

This step offers Boolean choices and three commands.

- 0 Indicate that crystal oscillator does not have a built-in CG
- 1 Indicate that crystal oscillator has a built-in CG (Note that an external CG is then necessary.)
- Accept the default (0) and advance to the next step
- (minus) Back up one step
- / Terminate editing and return to the operating menu

⑥ LCD voltage regulator flag

Voltage Regulator for LCD (No use : 0 / Use : 1)

Input ---> __

This step offers Boolean choices and three commands available. Enter a number or one of the three commands.

- 0 Indicate that there is no voltage regulator
- 1 Indicate that there is a voltage regulator
- Accept the default (0) and advance to the next step
- (minus) Back up one step
- / Terminate editing and return to the operating menu

⑦ Saving the file

When editing is complete, the software displays the following prompt. (See Note 6.)

File Create ? (Y / N) ---> __

Enter “Y” to save the data to a disk file; “N” to discard the data. The former produces the following two messages at the start and end of the file save operation.

File Creating ...

The software then returns to the operation menu.

HEX File M168_ XXX.HEX Created

Note 6

This step is also the final one when adding to the LCD segment mask option table.

2.3 Adding to LCD Segment Mask Option Table

Item #2 on the operation menu activates the LCD segment mask option table editor at the end of the LCD segment mask option table so that you can add more data without having to scroll through existing entries. Other than that, operation is identical to that described in the preceding Section.

```
[[ SEGMENT APPEND MODE ]]
```

```
<< ML64168 - XXX >>  
** SEGMENT No.Lx **
```

Here, Lx is the segment number (L0 to L33) following the last one entered in the table. If the table is full, however, the starting point is L33.

For further details, see the preceding Section.

2.4 Editing LCD Segment Mask Option Table





Item #3 on the operation menu displays ten LCD segment mask option table entries and a prompt for specifying the entry to edit.

[[DISPLAY & EDIT MODE]]

<< ML64168 - XXX >> - Segment Data - Page 1

SEG	SIGNAL			I/C/S/P	COM1		COM2		COM3	
					DATA	DSPR	DATA	DSPR	DATA	DSPR
L0	XXX/	XXX/	XXX	S	a	12	b	12	c	17
L1	/	/
L2	/	/
L3	/	/
L4	/	/
L5	/	/
L6	/	/
L7	/	/
L8	/	/
L9	/	/

Edit Number (Next : CR, Bank : -, To Menu : /) ---> __

- number  Specify the entry number (In this example, the number must be between 0 and 9.)
- (minus)  Scroll back ten entries
-  Scroll forward ten entries
- /  Terminate editing and return to the operating menu

Entering a number displays the prompt for specifying the pin configuration (common, segment, or port).



The example above shows the entries for segment numbers 0 to 9 using 1/3 duty.

[[DISPLAY & EDIT MODE]]

<< ML64168 - XXX >>

SEG	SIGNAL	C/S/P	COM1		COM2		COM3	
			DATA	DSPR	DATA	DSPR	DATA	DSPR
LX	XXX/ XXX/ XXX	S	a	12	b	12	c	17

↓

Com/ Seg/ Port ---> _

(See Note 7.)

From this point onward, the prompts and data entry procedures are virtually the same as those in the preceding two sections. One difference, however, is that entering a space leaves the current data unchanged and advances to the next column.

Example

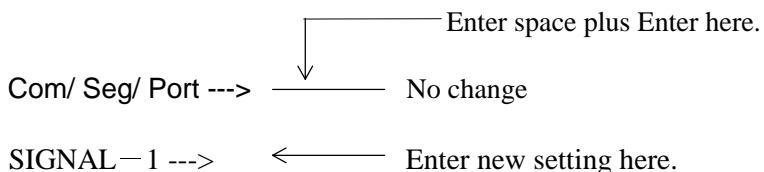

Reaching the end of the LCD segment mask option table or terminating the editor with the “/” command usually produces an “Update?” prompt similar to the “Create?” prompt for menu entry #1. If there have been no modifications, however, the program returns immediately to the operating menu.

Note 7

The first column on this single-entry display gives the segment number—L10 for entry #10, for example.



Entering “.” (unused) in a SIGNAL column automatically sets all DATA-DSPR pairs to “.” as well.

2.5 Editing Remaining Mask Options

Item #4 on the operation menu displays the current settings for the remaining mask options and a confirmation prompt.

```

[[ OPTION DATA EDIT MODE ]]

<< MSM64162A - XXX >>      -Option Data-
+-----+-----+-----+
| Voltage of Power Supply | X'tal CG Existence | LCD Voltage Regulator |
+-----+-----+-----+
| 0 : 1.5v / 1 : 3.0v    | 0 : No Exist / 1 : Exist | 0 : No Use / 1 : Use  |
+-----+-----+-----+
|           X            |           X            |           X            |
+-----+-----+-----+

Edit Option Data ?( Y / N ) --->  _
    
```

Enter “Y” to continue or “N” to cancel.

Y Edit the remaining mask options

N Cancel menu command

From this point onward, the prompts and procedures resemble those in the second half (steps 4 to 6) of the procedure for menu item #1.

One minor difference, however, is that pressing the Enter key does not produce the default setting. Rather it leaves the current setting unchanged.

The first prompt is for the power supply voltage. (Step 4)

```

[[ OPTION DATA EDIT MODE ]]

<< ML64168 - XXX >>

Voltage of Power Supply (1.5v : 0 / 3v : 1)

Input --->  _
    
```

The second prompt is for the crystal oscillator capacitor CG flag. (Step 5)

X'tal CG Existence (Nonexist : 0 / Exist : 1) Input ---> __

The third prompt is for the LCD voltage regulator flag. (Step 6)

Voltage Regulator for LCD (No use : 0 / Use : 1) Input ---> __

Pressing the Enter key returns immediately to the operating menu. If there have been modifications, however, the program displays an “Update?” prompt similar to the “Create?” prompt for menu entry #1.

File Create ? (Y / N) ---> __

Enter “Y” to save the remaining mask options to a disk file; “N” to discard the changes.

2.6 Printing LCD Segment Mask Option Table

Item #5 on the operation menu sends the LCD segment mask option table to the printer, but first displays a prompt.

*** Setup Printer & Hit Anykey!! (ESC : To MENU) ***

Press a key when printer ready. (Esc for menu)

Make sure that the printer is connected, turned on, and on line. Then press the space bar, Enter key, or whatever. Alternatively, press the Esc key to cancel the print request and return to the operation window. The Esc key can also be used to cancel even after printing has started.



In some situations, pressing a key while the printer is off or otherwise unavailable can lead to keyboard lockup, so carefully check all printer connections.

2.7 Displaying Display Data Register and Bit Assignments

Item #6 on the operation menu displays an SRF table listing the current display data registers (DSPR) and bit (DATA) assignments in the following format.

[[SFR TABLE DISPLAY MODE]]

<< ML64168 – XXX >> – Address / DSPR – Page X

ADDRESS	DSPR	SEG-d	SEG-c	SEG-b	SEG-a
.
.
.
.
.
.
.
.
.
.

[● : Already used]

The block dots in the table indicate display data register bits available for assignment to data registers. All other bits are unavailable. Use this table to check assignments after creating or updating the LCD segment mask option table.



Bits without the block dots are not physically present in the ML64168.

2.8 Invoke Subshell

Item #7 on the operation menu displays a command line prompt by invoking the program specified by the environment variable COMSPEC as a subshell. Unlike exiting MASK168, however, this approach provides less memory because MASK168 itself takes up approximately 90 kilobytes, and the command line interpreter takes up additional space.

90 kilobytes plus resident portion of command line interpreter

The standard command for closing such subshells is EXIT.

A > EXIT ■

2.9 Exiting Program

Item #8 on the operation menu immediately terminates MASK168 execution.



Make sure that you have saved any new data or modifications first.

Chapter 3. Output Files

This Chapter describes the various files created by the MASK168 mask option generator.

1. Mask Option Files

Based on the mask option specifications from the preceding Chapter, the MASK168 mask option generator produces 15 files.

SEG64168.XXX	SD168_1.XXX
DUTY168.XXX	SD168_2.XXX
OP168.XXX	SD168_3.XXX
DN168_1.XXX	SD168_4.XXX
DN168_2.XXX	SS168.XXX
DN168_3.XXX	CS168_1.XXX
DN168_4.XXX	CS168_2.XXX
M168_XXX.HEX	



Throughout this document, the XXX in file names and extensions is the chip code, a three-digit identifier for distinguishing chip versions (ML64168-XXX). For further details, see Section 2.1.3 “Specifying Chip Code.”

1.1 SEG64168.XXX

This file contains the LCD segment data for all segments. MASK168 reads it in if it is available.

1.2 DUTY168.XXX

This file contains the duty specification. MASK168 reads it in if it is available.

1.3 OP168.XXX

This file contains the remaining mask options: operating power supply voltage, crystal oscillator capacitor CG flag, and LCD voltage regulator flag. MASK168 reads it in if it is available.

1.4 DN168_n.XXX ($n=1$ to 4)

The file with n contains the display register numbers for COM n .

1.5 SD168_ n.XXX (*n=1 to 4*)

The file with n contains the segment data for COMn.

1.6 SS168.XXX

This file contains the segment attribute data.

1.7 CS168_ n.XXX (*n=1 to 2*)

These files contain common select data inside the ML64168 chip The Intel HEX format mask option file from the MASK168 mask option generator. The one with 1 gives the following voltage levels: VDD, VPC, VPS, VNC, VNS, and VSS; the one with 2, the following LCD display control signals: CON, COF, POLS, POLC, TDC1, PON, and POF.

1.8 M168_ XXX.HEX

This Intel HEX format mask option file combines the data in the above 14 files for downloading to the EASE64168.

2. Addresses for Mask Option Data

The following Table shows how the Intel HEX format mask option file from the MASK168 mask option generator maps the mask options to memory addresses.

Table 3-1 Addresses for Mask Option Data

Address	Data
000H to 021H	Display register numbers for COM1
100H to 121H	Display register numbers for COM2
200H to 221H	Display register numbers for COM3
300H to 321H	Display register numbers for COM4
400H to 421H	Segment data for COM1
500H to 521H	Segment data for COM2
600H to 621H	Segment data for COM3
700H to 721H	Segment data for COM4
800H to 821H	Segment attribute data
900H to 921H	Top 6 bits of common select data
A00H to A21H	Bottom 7 bits of common select data
B00H	Option data

Appendices

Appendix-1 Data Tables

Appendix-2 Sample Completed Mask Options Tables

Appendix-1 Data Tables

Table AP-1 Display Register Number Data Table

DSPR	AD4	AD3	AD2	AD1	AD0	DSPR	AD4	AD3	AD2	AD1	AD0
00	01	01	01	01	01	11	01	10	01	10	10
01	01	01	01	01	10	12	01	10	10	01	01
02	01	01	01	10	01	13	01	10	10	10	10
03	01	01	01	10	10	14	01	10	10	01	01
04	01	01	10	01	01	15	01	10	10	10	10
05	01	01	10	01	10	16	10	01	01	01	01
06	01	01	10	10	01	17	10	01	01	10	10
07	01	01	10	10	10	18	10	01	01	01	01
08	01	10	01	01	01	19	10	01	01	10	10
09	01	10	01	01	10	20	10	01	10	01	01
10	01	10	01	10	01						

This table specifies the data for creating the DN168_n.XXX (n=1 to 4) files containing the display register numbers for COMn.

The Intel HEX format mask option file (M168_XXX.HEX) places this data at addresses 0H to 321H.

Table AP-2 Segment Data Table

	DATA	AD7	AD6	AD5	AD4	AD3	AD2	AD1	AD0
Even-numbered DSPRs	a	0	0	0	0	0	0	0	1
	b	0	0	0	0	0	0	1	0
	c	0	0	0	0	0	1	0	0
	d	0	0	0	0	1	0	0	0
Odd-numbered DSPRs	a	0	0	0	1	0	0	0	0
	b	0	0	1	0	0	0	0	0
	c	0	1	0	0	0	0	0	0
	d	1	0	0	0	0	0	0	0

This table specifies the data for creating the SD168_n.XXX (n=1 to 4) files containing the segment data for COMn.

The Intel HEX format mask option file (M168_XXX.HEX) places this data at addresses 400H to 721H.

Table AP-3 Segment Attribute Table

Segment pin attribute	S4	S4	S3	S3	S2	S2	S1	S1
Used as COM1	0	1	0	1	0	1	1	0
Used as COM2	0	1	0	1	1	0	0	1
Used as COM3	0	1	1	0	0	1	0	1
Used as COM4	1	0	0	1	0	1	0	1
Used as 1/4 SEG	0	0	0	0	0	0	0	0
Used as 1/3 SEG	0	1	0	0	0	0	0	0
Used as 1/2 SEG	0	1	0	1	0	0	0	0
Used as PORT	0	1	0	1	0	1	0	0
Unused	0	1	0	1	0	1	0	1

(See note 1)
(See note 1)
(See note 1)

This table specifies the data for creating the SD168.XXX file containing the segment attribute data.

The Intel HEX format mask option file (M168_XXX.HEX) places this data at addresses 800H to 821H.

Note 1

These settings apply only when all data registers are used. If data registers are unused, substitute the following table instead.

Table AP-4 Segment Attribute Table When Pins Unused

Segment pin attribute	S4	S4	S3	S3	S2	S2	S1	S1
1/4 duty SEG (No unused pins)	0	0	0	0	0	0	0	0
1/4 duty SEG (COM1 unused)	0	0	0	0	0	0	0	1
1/4 duty SEG (COM2 unused)	0	0	0	0	0	1	0	0
1/4 duty SEG (COM1 and COM2 unused)	0	0	0	0	0	1	0	1
1/4 duty SEG (COM3 unused)	0	0	0	1	0	0	0	0
1/4 duty SEG (COM1 and COM3 unused)	0	0	0	1	0	0	0	1
1/4 duty SEG (COM2 and COM3 unused)	0	0	0	1	0	1	0	0
1/4 duty SEG (COM1, COM2, and COM3 unused)	0	0	0	1	0	1	0	1
1/3 duty SEG (No unused pins)	0	1	0	0	0	0	0	0
1/3 duty SEG (COM1 unused)	0	1	0	0	0	0	0	1
1/3 duty SEG (COM2 unused)	0	1	0	0	0	1	0	0
1/3 duty SEG (COM1 and COM2 unused)	0	1	0	0	0	1	0	1
1/2 duty SEG (No unused pins)	0	1	0	1	0	0	0	0
1/2 duty SEG (COM1 unused)	0	1	0	1	0	0	0	1
1/2 duty SEG (COM2 unused)	0	1	0	1	0	1	0	0

Table AP-5 Common Select Data Table

C/S/P	VDD	VPC	VPS	VNC	VNS	VSS	CON	COF	POLS	POL C	TDC1	PON	POF
C	0	1	0	1	0	0	1	0	0	1	0	0	1
S	0	0	1	0	1	0	0	1	1	0	0	0	1
P	1	0	0	0	0	1	0	1	0	0	1	1	0
Unused	0	1	0	1	0	0	1	0	0	1	0	0	1

CS168_1.XXX data
CS168_2.XXX data

This table specifies the data for creating the CS168_n.XXX (n=1 to 2) files containing options for voltage levels and LCD display control signals. The Intel HEX format mask option file (M168_XXX.HEX) places this data at addresses 900H to A21H.

Table AP-6 Option Data Table

LCD Voltage Regulator	Power Supply Voltage	CG	Data
Unused	1.5 V	Unused	00
Unused	1.5 V	Used	01
Unused	3.0 V	Unused	02
Unused	3.0 V	Used	03
Used	1.5 V	Unused	04
Used	1.5 V	Used	05
Used	3.0 V	Unused	06
Used	3.0 V	Used	07

This table specifies the data for creating the OP168.XXX file containing the remaining mask options. The Intel HEX format mask option file (M168_XXX.HEX) places this data at addresses B00H.

Appendix-2 Sample Completed Mask Options Tables

—1/3 DUTY—

SEG	SIGNAL			C/S/P	COM1		COM2		COM3	
					DATA	DSPR	DATA	DSPR	DATA	DSPR
L0	L1/	9A/	1C	S	a	10	a	08	c	00
L1	L2/	1B/	1G	S	b	10	b	00	c	01
L2	1A/	1F/	1E	S	a	00	b	01	a	01
L3	2B/	2C/	L10	S	b	02	c	02	b	09
L4	2A/	2G/	2D	S	a	02	c	03	d	02
L5	2F/	2E/	.	S	b	03	a	03	.	00
L6	3B/	3C/	L11	S	b	04	c	04	c	09
L7	3A/	3G/	3D	S	a	04	c	05	d	04
L8	L3/	3F/	3E	S	c	10	b	05	a	05
L9	L4/	4B/	.	S	d	10	b	06	.	00
L10	4A/	4G/	4C	S	a	06	c	07	c	06
L11	4F/	4E/	4D	S	b	07	a	07	d	06
L12	L5/	L6/	L7	S	a	12	b	12	c	12
L13	./	./	COM3	C	.	00	.	00	.	00
L14	./	./	.	.	.	00	.	00	.	00
L15	./	./	.	.	.	00	.	00	.	00
L16	./	./	.	.	.	00	.	00	.	00
L17	./	./	.	.	.	00	.	00	.	00
L18	./	./	.	.	.	00	.	00	.	00
L19	./	COM2	.	C	.	00	.	00	.	00
L20	COM1	./	.	C	.	00	.	00	.	00
L21	L8/	8E/	8F	S	d	12	a	17	b	17
L22	8D/	8G/	8A	S	d	16	c	17	a	16
L23	8C/	8B/	7A	S	c	16	b	16	a	14

Voltage of Power Supply	X'tal CG Existence	LCD Voltage Regulator
0 : 1.5v / 1 : 3.0v	0 : No Exist / 1 : Exist	0 : No Use / 1 : Use
0	0	0

-1/4 DUTY-

SEG	SIGNAL				C/S/P	COM1		COM2		COM3		COM4	
						DATA	DSPR	DATA	DSPR	DATA	DSPR	DATA	DSPR
L0	COM1/	/	/	.	C	.	00	.	00	.	00	.	00
L1	8A/	8B/	10B/	10A	S	a	10	b	10	b	14	a	14
L2	8F/	8G/	10F/	8C	S	b	11	c	11	b	15	c	10
L3	8E/	8D/	9C/	9B	S	a	11	d	01	c	12	b	12
L4	DEGREE/	19/	9G/	9A	S	d	09	d	11	c	13	a	12
L5	7B/	7C/	9F/	9H	S	b	08	c	08	b	13	d	13
L6	7A/	7G/	9J/	7D	S	a	08	c	09	d	14	d	08
L7	7F/	6B/	14B/	14C	S	b	09	b	06	b	14	c	14
L8	6A/	6G/	6D/	RECALL	S	a	06	c	07	d	06	a	18
L9	4A/	4G/	4D/	SPL	S	a	04	c	05	d	04	d	15
L10	4F/	4E/	HAND/	20	S	b	05	a	05	d	17	c	—
L11	3B/	3C/	BUZZER/	TMR	S	b	02	c	02	c	20	d	18
L12	3A/	3G/	3D/	12B	S	a	02	c	03	d	02	b	—
L13	3F/	3E/	BELL/	STW	S	b	03	a	03	a	19	b	19
L14	17/	18/	2C/	RPT	S	b	07	a	10	c	00	d	19
L15	2A/	2B/	2G/	2D	S	a	00	b	00	c	01	d	00
L16	1B/	2F/	2E/	12A	S	b	18	b	01	a	01	a	09
L17	/	COM2/	/	.	C	.	00	.	00	.	00	.	00
L18	/	/	COM3/	.	C	.	00	.	00	.	00	.	00
L19	/	/	/	COM4	S	.	00	.	00	.	00	.	00
L20	12D/	1C/	11B/	12E	S	d	10	c	15	b	18	a	11
L21	12C/	P/	12F/	12G	S	c	18	d	16	b	20	c	19
L22	13E/	4C/	ALM/	13F	S	a	13	c	04	d	20	b	16
L23	13D/	4B/	13A/	13G	S	d	12	b	04	a	20	c	16

Voltage of Power Supply	X'tal CG Existence	LCD Voltage Regulator
0 : 1.5v / 1 : 3.0v	0 : No Exist / 1 : Exist	0 : No Use / 1 : Use
1	1	1