

OKI electronic components

KGF1155B/1155

Small-Signal Amplifier

GENERAL DESCRIPTION

The KGF1155B is a small-signal UHF-band amplifier that features low noise and low current operation. The KGF1155B specifications are guaranteed to a fixed matching circuit of 5 V and 850 MHz; external impedance-matching circuits are also required. Because of the dual gate configuration, low noise, and low operating current, the KGF1155B is ideal as a receiver mixer for personal handy phones.

The KGF1155 is an amplifier similar to the KGF1155B in specifications and typical properties. Although having S Parameters slightly different from those of the KGF1155B, the KGF1155 meets the specifications for the KGF1155B, even with the same matching circuits as those of the KGF1155B.

FEATURES

- Low current operation: 2.5 mA (max.)
- High output power: 3 dBm (min.)
- Low noise: 3 dB (max.)
- Self-bias circuit configuration with built-in source capacitor
- Package: 4PSOP

PACKAGE DIMENSIONS

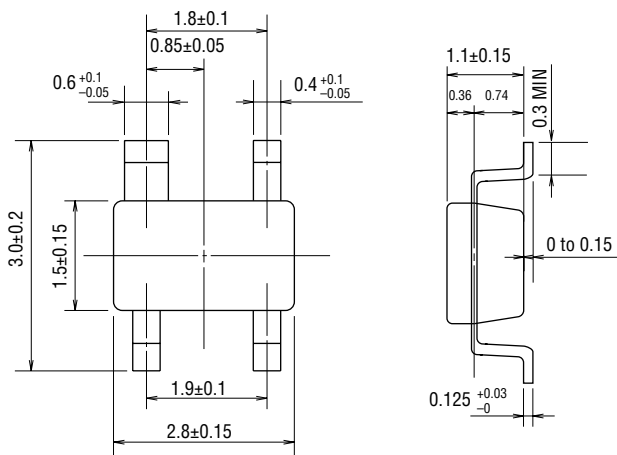

(Unit: mm)

Package material	Epoxy resin
Lead frame material	42 alloy
Pin treatment	Solder plating
Solder plate thickness	5 μm or more

Note: Ask our sales department for detailed requirements of the KGF1155.

MARKING

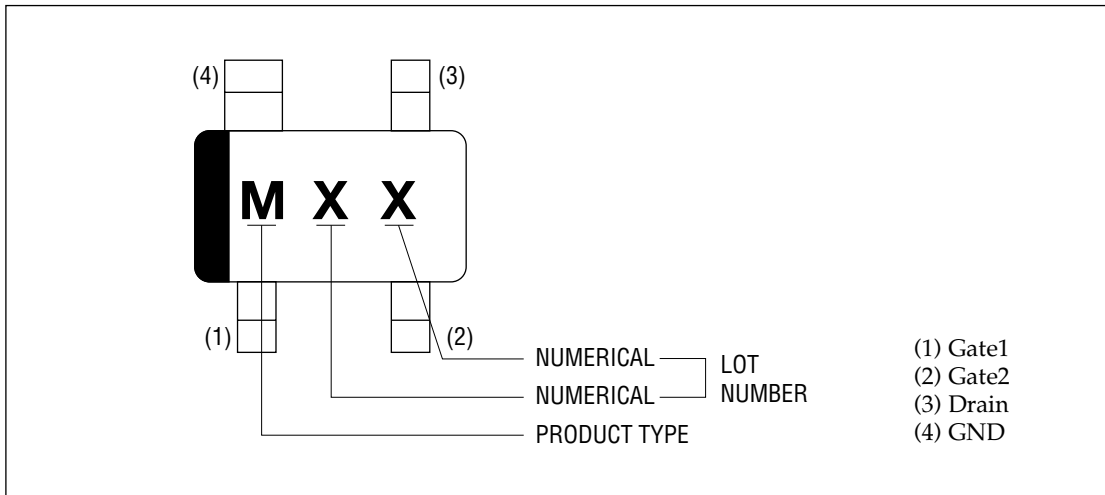

CIRCUIT

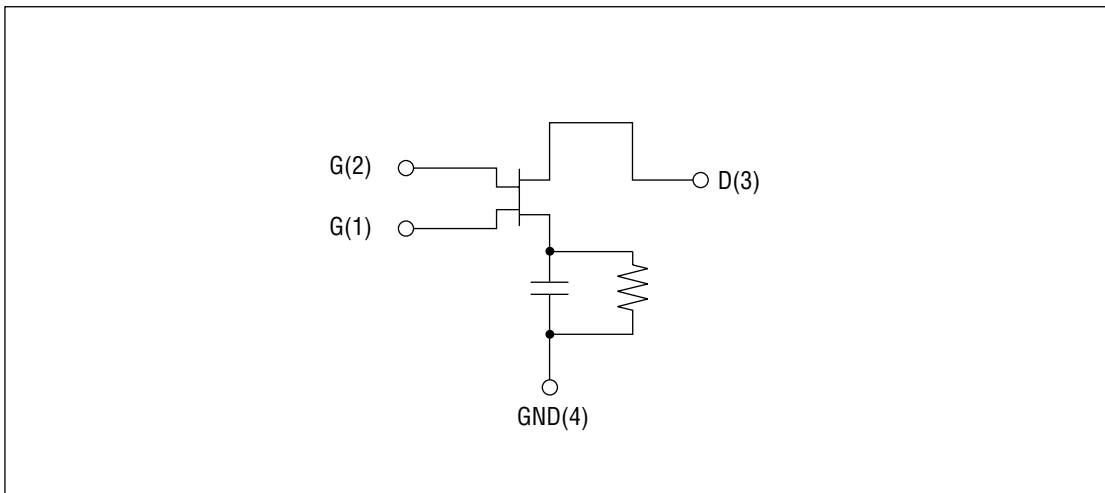

ABSOLUTE MAXIMUM RATINGS

Item	Symbol	Condition	Unit	Min.	Max.
Drain-source voltage	V_{DS}	$T_a = 25^{\circ}\text{C}$	V	—	7.0
Gate-source voltage	V_{GS}	$T_a = 25^{\circ}\text{C}$	V	-3.0	0.4
Drain current	I_{DS}	$T_a = 25^{\circ}\text{C}$	mA	—	60
Total power dissipation	P_{tot}	$T_a = 25^{\circ}\text{C}$	mW	—	200
Channel temperature	T_{ch}	—	$^{\circ}\text{C}$	—	150
Storage temperature	T_{stg}	—	$^{\circ}\text{C}$	-45	125

ELECTRICAL CHARACTERISTICS

(Ta = 25°C)

Item	Symbol	Condition	Unit	Min.	Typ.	Max.
Gate-source leakage current	I_{GSS}	$V_{GS(1,2)} = -3\text{ V}$	μA	—	—	12
Gate-drain leakage current	I_{GDO}	$V_{GD(1,2)} = -8\text{ V}$	μA	—	—	60
Drain-source leakage current	$I_{DS(off)}$	$V_{DS} = 3\text{ V}, V_{GS(1,2)} = -2.5\text{ V}$	μA	—	—	120
Operating current	I_D	(*1), $P_{IN} = -20\text{ dBm}$	mA	—	—	2.5
Gate-source cut-off voltage	$V_{GS(off)}$	$V_{DS} = 3\text{ V}, I_{DS} = 120\ \mu\text{A}$	V	-2.0	—	-1.0
Noise figure	F	(*1)	dB	—	—	3.0
Linear gain	G_{LIN}	(*1), $P_{IN} = -20\text{ dBm}$	dB	12.0	—	—
Output power	P_O	(*2), $P_{IN} = -3\text{ dBm}$	dBm	3.0	—	—
Third-order intercept point	IP_3	(*1), $f_2 = 851\text{ MHz}$	dBm	—	11	—

*1 Self-bias condition: $V_{DD} = 5.0\text{ V} \pm 0.25\text{ V}$, $V_{G1} = 0\text{ V}$, $V_{G2} = 1.0\text{ V}$, $f = 850\text{ MHz}$ *2 Self-bias condition: $V_{DD} = 5.0\text{ V} \pm 0.25\text{ V}$, $V_{G1} = 0\text{ V}$, $V_{G2} = 1.5\text{ V}$, $f = 850\text{ MHz}$

RF CHARACTERISTICS

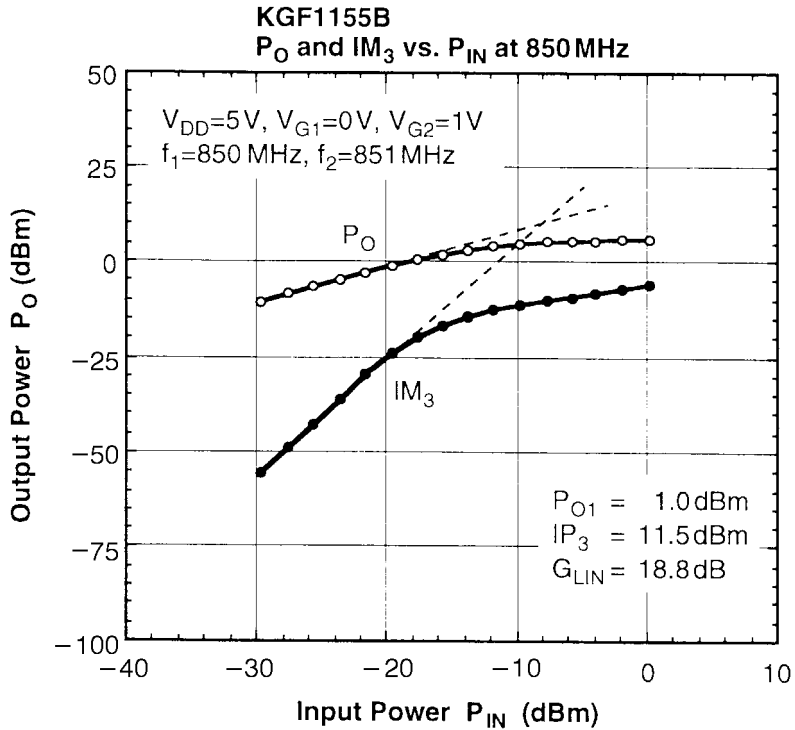
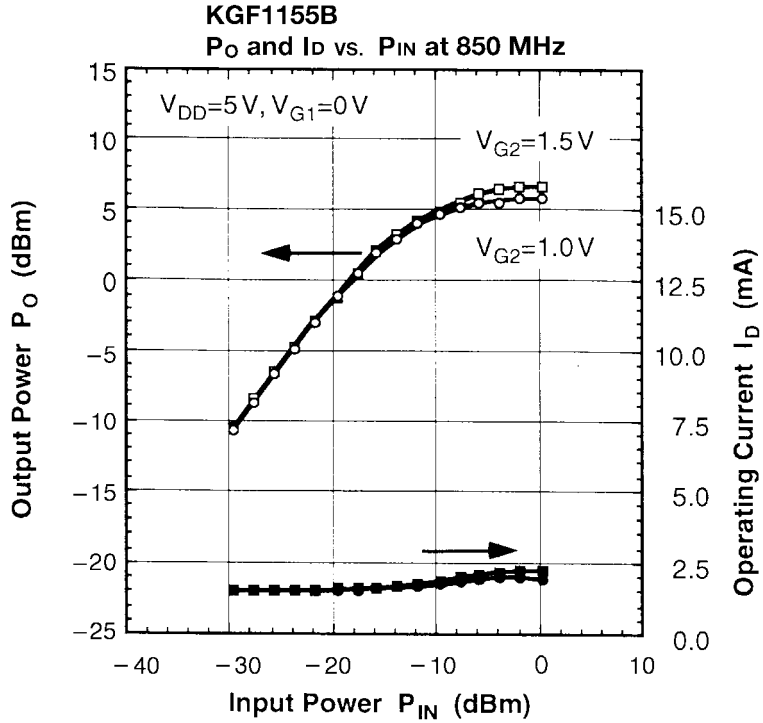

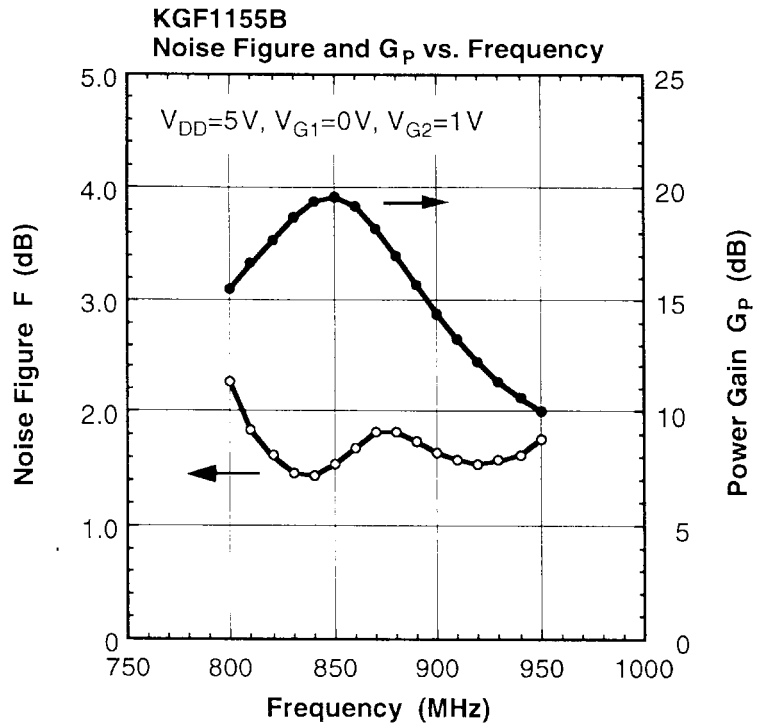

Typical S Parameters of KGF1155B

 $V_{DD} = 5\text{ V}$, $V_{G1} = 0\text{ V}$, $V_{G2} = 1\text{ V}$, $I_D = 1.47\text{ mA}$

Freq(MHz)	MAG(S ₁₁)	ANG(S ₁₁)	MAG(S ₂₁)	ANG(S ₂₁)	MAG(S ₁₂)	ANG(S ₁₂)	MAG(S ₂₂)	ANG(S ₂₂)
500.0	1.003	-11.21	1.039	167.37	0.004	81.47	0.974	-6.35
600.0	0.998	-13.33	1.043	162.83	0.005	80.47	0.974	-7.50
700.0	0.998	-15.65	1.046	158.63	0.006	72.42	0.973	-8.76
800.0	0.995	-17.93	1.052	154.37	0.007	79.91	0.975	-10.01
900.0	0.990	-20.15	1.047	150.90	0.007	76.16	0.973	-11.43
1000.0	0.987	-22.38	1.055	146.74	0.007	73.24	0.977	-12.49
1100.0	0.983	-24.65	1.052	142.66	0.008	72.66	0.976	-13.68
1200.0	0.977	-26.97	1.060	139.29	0.008	78.86	0.977	-14.91
1300.0	0.973	-29.11	1.057	136.12	0.009	75.51	0.975	-16.25
1400.0	0.964	-31.48	1.062	132.38	0.009	69.60	0.975	-17.35
1500.0	0.960	-33.68	1.076	128.66	0.008	73.17	0.980	-18.54
1600.0	0.953	-35.98	1.081	125.38	0.009	73.89	0.979	-19.75
1700.0	0.946	-38.10	1.077	122.17	0.008	74.65	0.983	-20.71
1800.0	0.935	-40.43	1.094	117.61	0.009	72.94	0.983	-22.43
1900.0	0.927	-42.85	1.100	114.04	0.009	76.94	0.988	-23.53
2000.0	0.916	-45.08	1.115	110.63	0.008	85.29	0.986	-24.53
2100.0	0.907	-47.36	1.133	107.37	0.009	85.24	0.991	-26.07
2200.0	0.900	-49.85	1.124	102.45	0.008	91.55	0.992	-26.86
2300.0	0.888	-52.09	1.133	98.73	0.007	99.54	0.996	-28.35
2400.0	0.874	-54.44	1.146	95.35	0.008	109.36	1.002	-29.36
2500.0	0.863	-56.69	1.149	91.22	0.007	119.89	1.003	-30.84
2600.0	0.848	-58.95	1.139	86.95	0.009	134.23	1.012	-32.10
2700.0	0.834	-61.27	1.166	82.74	0.008	141.12	1.011	-33.39
2800.0	0.817	-63.61	1.170	79.25	0.011	154.76	1.022	-35.07
2900.0	0.806	-65.83	1.187	74.61	0.012	159.19	1.027	-36.13
3000.0	0.789	-68.06	1.192	70.19	0.016	165.49	1.028	-37.60

Typical S Parameters of KGF1155B

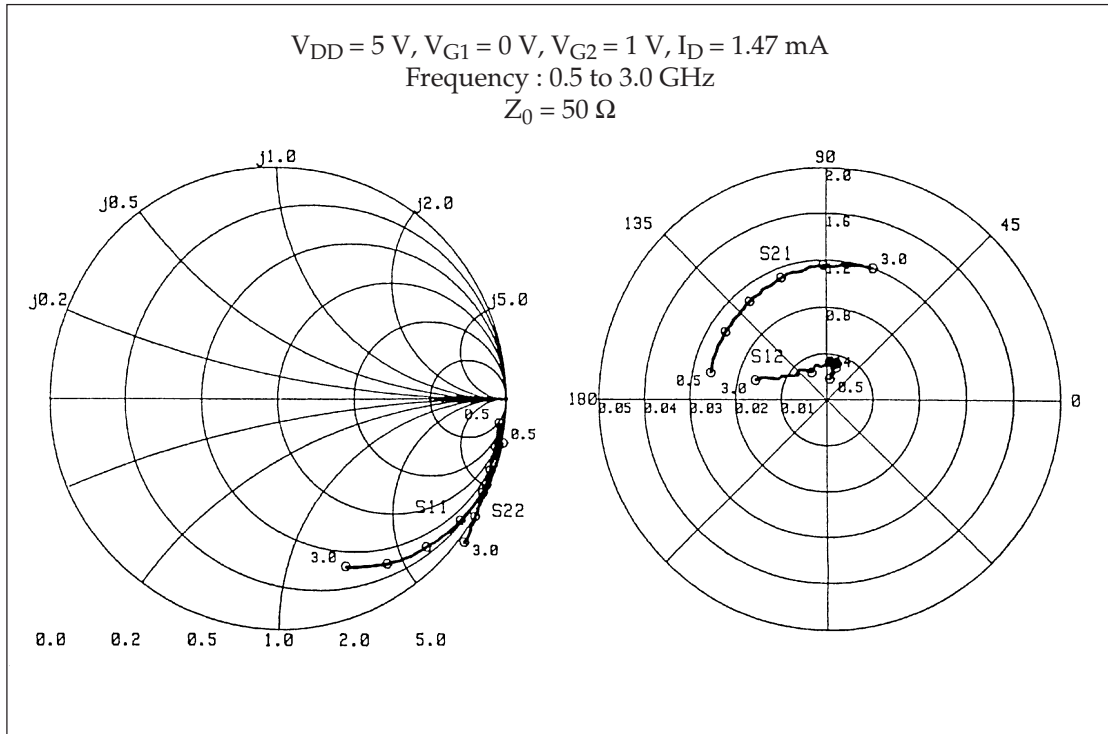

Test Circuit and Bias Configuration for KGF1155B at 850 MHz

